



Thermal Edge Inc.TM

TEMPERATURE CONTROL SOLUTIONS FOR ELECTRICAL ENCLOSURES

UL LISTED ENCLOSURE AIR CONDITIONERS

Fully Integrated Condensate Evaporation Package
Programmable Digital Controller
Thermal Expansion Valve
Narrow Design To Fit Onto A 12" Enclosure
Energy Efficient - Low Running Amps
50 Hz Enclosure Air Conditioners
60 Hz Hazardous Locations Enclosure Air Conditioners
50 Hz Hazardous Locations Enclosure Air Conditioners



MADE IN AMERICA MATTERS...



WHAT MAKES AN AIR CONDITIONER A THERMAL EDGE AIR CONDITIONER?

There are three critical features that make a Thermal Edge Enclosure Air Conditioner different from any other line of air conditioners. Standard on Every Unit:

DRIP-FREE CONDENSATE REMOVAL IS NOT OPTIONAL

Condensate Evaporation Is Standard On Every Unit... NO DRAIN TUBE IS NEEDED

DIGITAL, PROGRAMMABLE CONTROLLER:

- Built in alarms and alerts
- Will operate heating & cooling
- Ethernet, Modbus RTU and EtherNet/IP communication options
- Remote controller option places controller inside cabinet

THERMAL EXPANSION VALVE CONTROLS THE FLOW

Thermal Expansion Valves balance and modulate the refrigerant flow to the heat load by sensing the temperature of the refrigerant leaving the evaporator.

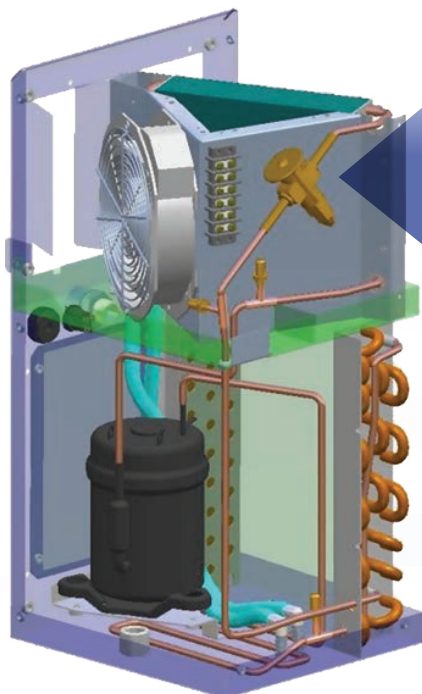

NO WATER DRIPS
FROM THERMAL EDGE
ENCLOSURE AIR
CONDITIONERS



CS SERIES AIR CONDITIONERS

Smallest 2000 BTUH available

- Active Condensate Evaporation is standard
- Fits on a 7" or 10" deep enclosure
- Available in UL Types 12, 4, 4X
- Fully programmable digital controller with temperature and pressure monitors for a smarter air conditioner
- 115V, 230V, 48VDC in 1000 BTUH
- 1000 BTUH
- 2000 BTUH



TM SERIES AIR CONDITIONERS

Top Mounted Enclosure Air Conditioners

- Active Condensate Evaporation is standard
- Available in UL Types 12, 4, 4X
- Fully programmable digital controller with temperature and pressure monitors for a smarter air conditioner
- 115V, 230V, 460V
- 6000 BTUH
- 8000 BTUH



NE SERIES AIR CONDITIONERS

Active Condensate Evaporation is standard

- Fits on a 12" deep enclosure
- Available in UL Types 12, 4, 4X and Hazardous Environment applications
- Fully programmable digital controller with temperature and pressure monitors for a smarter air conditioner
- 115V, 230V, 460V, 48VDC in 4000 BTUH
- 1000 BTUH
- 1500 BTUH
- 2000 BTUH
- 3000 BTUH
- 4000 BTUH
- 5000 BTUH
- 6000 BTUH
- 8000 BTUH



HC SERIES AIR CONDITIONERS

Active Condensate Evaporation is standard

- Available in UL Types 12, 4, 4X and Hazardous Environment applications
- Fully programmable digital controller with temperature and pressure monitors for a smarter air conditioner
- 115V, 230V, 460V
- 10,000 BTUH
- 12,000 BTUH
- 15,000 BTUH
- 20,000 BTUH
- 20,000 BTUH



AIR CONDITIONER PRODUCT LINE

Model	BTU/Hour	Voltage/ Phase/Hz	Running Amps	Max. Ambient Temp	Max. Integrated Heat (Watts)	H x W x D	Unit Weight
CS011D48	1,000	48 VDC	3.5	131°F	NA	17" x 7" x 7"	31
CS011126	1,000	120/1/60	2.7	131°F	350	17" x 7" x 7"	31
NE010126	1,000	120/1/60	3.44	125°F	NA	22" x 11.8" x 8.5"	51
NE010236	1,000	230/1/60	2.67	125°F	NA	22" x 11.8" x 8.5"	53
NE015126	1,500	120/1/60	3.44	125°F	NA	22" x 11.8" x 8.5"	51
NE015236	1,500	230/1/60	2.67	125°F	NA	22" x 11.8" x 8.5"	53
CS020126	2,000	120/1/60	4.1	131°F	500	20" x 10" x 10"	44
CS020236	2,000	230/1/60	2.0	131°F	500	20" x 10" x 10"	49
NE020D48	2,000	48 VDC	5.7	131°F	NA	35.27" x 11.8" x 9.5"	103
NE020126	2,000	120/1/60	3.3	134°F	1000	32" x 11.8" x 9.5"	60
NE020236	2,000	230/1/60	3.07	125°F	1000	32" x 11.8" x 9.5"	72
NE02S486	2,000	480/1/60	0.87	134°F	1000	32" x 11.8" x 15.1"	94
NE020486	2,000	480/1/60	0.87	134°F	1000	38" x 11.8" x 9.5"	94
NE030D48	3,000	48 VDC	8.7	131°F	NA	35.27" x 11.8" x 9.5"	103
NE030126	3,000	120/1/60	4.86	140°F	1000	32" x 11.8" x 9.5"	70
NE030236	3,000	230/1/60	3.07	125°F	1000	32" x 11.8" x 9.5"	72
NE03S486	3,000	480/1/60	1.28	140°F	1000	32" x 11.8" x 15.1"	103
NE030486	3,000	480/1/60	1.28	140°F	1000	38" x 11.8" x 9.5"	103
NE040D48	4,000	48 VDC	17.5	131°F	NA	35.27" x 11.8" x 9.5"	103
NE040126	4,000	120/1/60	6.76	125°F	1000	32" x 11.8" x 9.5"	70
NE040236	4,000	230/1/60	3.07	125°F	1000	32" x 11.8" x 9.5"	72
NE04S486	4,000	480/1/60	1.69	125°F	1000	32" x 11.8" x 15.1"	103
NE040486	4,000	480/1/60	1.69	125°F	1000	38" x 11.8" x 9.5"	103
NE050126	5,000	120/1/60	6.14	140°F	1000	36" x 11.8" x 15.1"	97
NE050236	5,000	230/1/60	3.76	140°F	1000	36" x 11.8" x 15.1"	92
NE050486	5,000	480/1/60	1.9	140°F	1000	44.63" x 11.8" x 15.1"	136
NE060126	6,000	120/1/60	7.83	125°F	1000	36" x 11.8" x 15.1"	97
NE060236	6,000	230/1/60	4.8	125°F	1000	36" x 11.8" x 15.1"	98
NE060486	6,000	480/1/60	2.4	125°F	1000	44.63" x 11.8" x 15.1"	142

AIR CONDITIONER PRODUCT LINE

(CONTINUED)

Model	BTU/Hour	Voltage/ Phase/Hz	Running Amps	Max. Ambient Temp	Max. Integrated Heat (Watts)	H x W x D	Unit Weight
TM061126	6,000	120/1/60	10.6	131°F	1000	15.6" x 26.3" x 20.2"	111
TM061236	6,000	230/1/60	6.0	131°F	1000	15.6" x 26.3" x 20.2"	111
TM061486	6,000	480/1/60	2.9	131°F	1000	15.6" x 26.3" x 20.2"	154
NE080126	8,000	120/1/60	7.83	125°F	1000	36" x 11.8" x 15.1"	102
NE080236	8,000	230/1/60	4.8	125°F	1000	36" x 11.8" x 15.1"	103
NE080486	8,000	480/1/60	2.4	125°F	1000	44.63" x 11.8" x 15.1"	142
TM081126	8,000	120/1/60	11.6	131°F	1000	15.6" x 26.3" x 20.2"	111
TM081236	8,000	230/1/60	7.0	131°F	1000	15.6" x 26.3" x 20.2"	111
TM081486	8,000	480/1/60	3.5	131°F	1000	15.6" x 26.3" x 20.2"	154
HC101126	10,000	120/1/60	19.4	131°F	1500	48" x 15.9" x 15.1"	162
HC101236	10,000	230/1/60	8.2	131°F	1500	48" x 15.9" x 15.1"	166
HC101486	10,000	480/1/60	4.1	131°F	1500	57.6" x 15.9" x 15.1"	232
HC121126	12,000	120/1/60	19.4	131°F	1500	48" x 15.9" x 15.1"	167
HC121236	12,000	230/1/60	8.2	131°F	1500	48" x 15.9" x 15.1"	163
HC121486	12,000	480/1/60	4.1	131°F	1500	57.6" x 15.9" x 15.1"	237
HC151236	15,000	230/1/60	9.93	140°F	1500	48" x 15.9" x 15.1"	170
HC151486	15,000	480/1/60	5.21	140°F	1500	57.6" x 15.9" x 15.1"	247
HC20C236	20,000	230/1/60	12.47	140°F	1500	48" x 15.86" x 15.03"	170
HC20C486	20,000	480/1/60	6.3	140°F	1500	57.6" x 15.86" x 15.03"	247

**1000 BTUH 48 VOLT DC POWERED AIR CONDITIONER
INDOOR/OUTDOOR, UL TYPES 12, 4 & 4X AVAILABLE**

Engineered & manufactured to endure the most difficult of environments and applications. Thermal Edge air conditioners will exceed environmental requirements in applications like Telecom Outside Plant, Off-Grid Solar, Wind & other Battery Powered Electrical Cabinets. The CS011 uses a unique 3 coil design providing high capacity cooling while utilizing air intake from either side. Dual intake allows for mounting on a wall mounted enclosure on the right or left side of your enclosure.



Digital Temperature Controller

- Programmable set point and temperature controls
- Visible Error and/or alarm messaging
- System status indication & keypad lockout function

Active Condensate Evaporation System

- Constant elimination of condensate
- Increases unit efficiency by pre-cooling refrigerant

Key Design Features

- Designed with rigid chassis and seam welded shroud
- Thoughtful interior design for easy maintenance
- Narrow body style fits on 8" enclosure
- Filter free design

Unit Efficiency

- Highly efficient rotary compressor
- Fully insulated & sealed cabinet
- Thermal Expansion Valve to maintain cooling capacity over a broad ambient temperature range

Compressor Protection System

- High & Low refrigerant cutouts with fault indication
- Compressor anti short cycle protection
- Thermal overload protector
- Compressor motor drive controller eliminates power inrush, saves energy and increases compressor life

OPTIONS:

- High Ambient
- Remote Controller
- Corrosion Protection
- Dry Contact
- Controller Programming
- Open Door Kill Switch
- Custom Finish
- Extended Temp. Probe
- Remote Control/Monitor

Model	UL Type	BTU/Hour	Material	Voltage	Running Amps	Max. Amb. Temp.	H x W x D	Unit Weight (lbs.)
CS011D4812	12	1000	Powder coated steel	48 VDC	3.5	131°F	17" x 7" x 7"	31
CS011D4804	4	1000	Powder coated steel	48 VDC	3.5	131°F	17" x 7" x 7"	31
CS011D484X	4X	1000	Stainless steel	48 VDC	3.5	131°F	17" x 7" x 7"	31
CS011D484XL6	4X	1000	Mill finish aluminum	48 VDC	3.5	131°F	17" x 7" x 7"	23

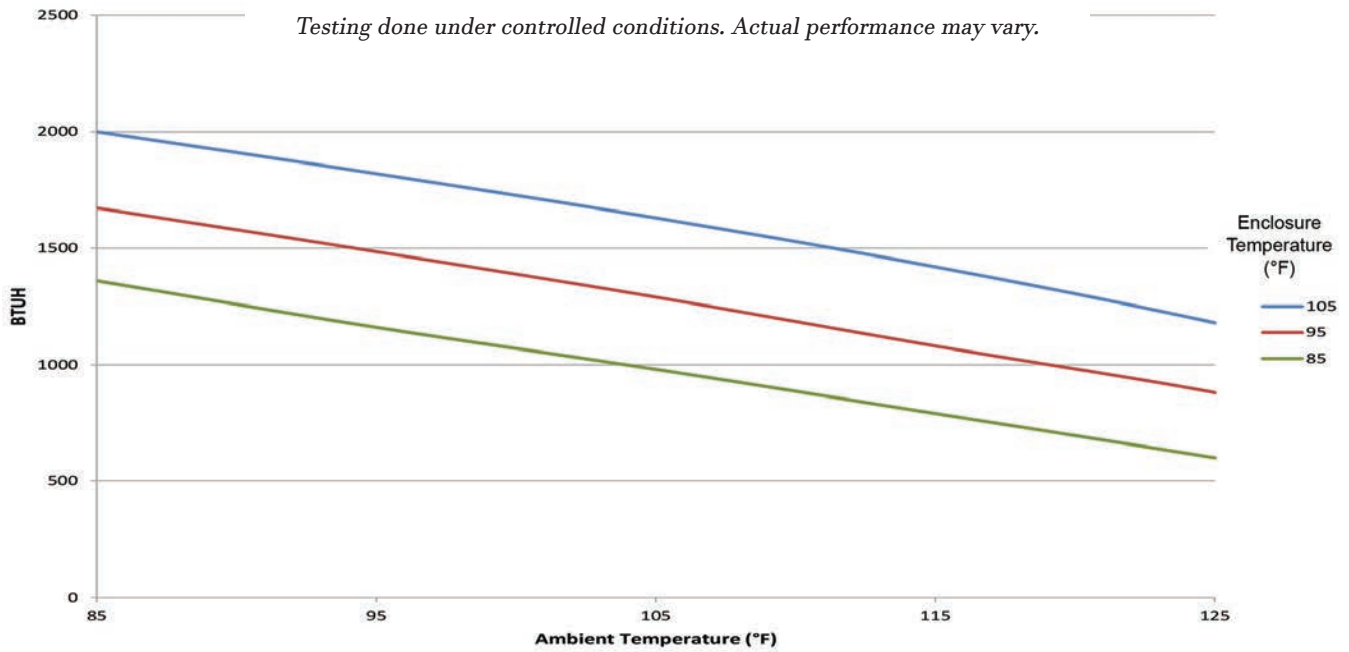

CS011
COMPACT SERIES
CS011 48VDC MODEL

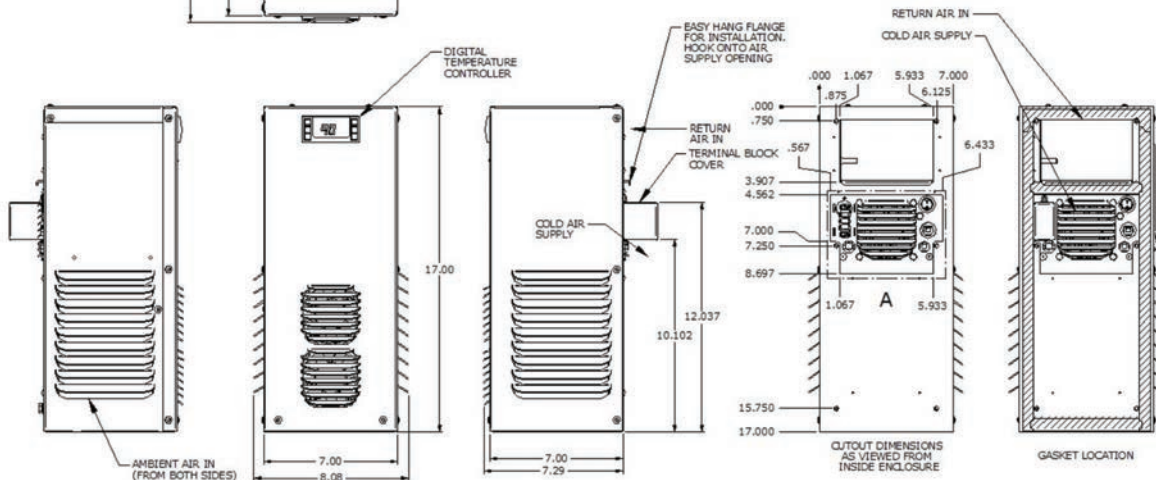
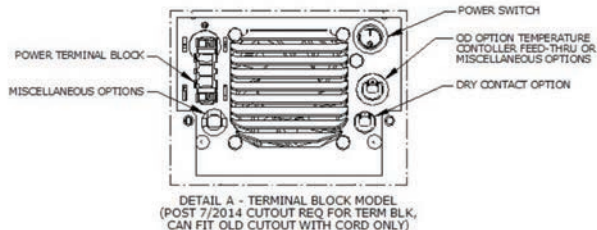
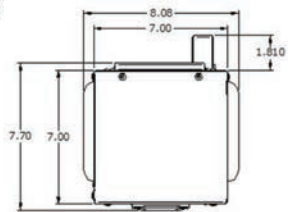

ATTENTION: If ordering a replacement for a Thermal Edge air conditioner, please include the part number and serial number of the unit being replaced in your order. This will ensure that we ship a replacement that is compatible with the cutout dimensions and power connection features of the older model. All information subject to change without notice.

1000 BTUH | INDOOR/OUTDOOR, UL TYPES 12, 4 & 4X AVAILABLE

Engineered & manufactured to endure the most difficult of environments and applications. Thermal Edge air conditioners will exceed environmental requirements in applications like Steel, Food Processing, Petro-Chemical, Cement, Paper & Pulp and Plastics. The CS011 uses a unique 3 coil design providing high capacity cooling while utilizing air intake from either side. Dual intake allows for mounting on a wall mounted enclosure on the right or left side of your enclosure.



Digital Temperature Controller

- Programmable set point and temperature controls
- Visible Error and/or alarm messaging
- System status indication & keypad lockout function

Active Condensate Evaporation System

- Constant elimination of condensate
- Increases unit efficiency by pre-cooling refrigerant

Key Design Features

- Designed with rigid chassis and seam welded shroud
- Thoughtful interior design for easy maintenance
- Narrow body style fits on 8" enclosure
- Filter free design

Unit Efficiency

- Temperature operated condenser fan reduces power inrush and saves energy
- Highly efficient rotary compressor
- Fully insulated & sealed cabinet
- Thermal Expansion Valve to maintain cooling capacity over a broad ambient temperature range

Compressor Protection System

- High & Low refrigerant cutouts with fault indication
- Compressor anti short cycle protection
- Thermal overload protector
- Compressor motor drive controller eliminates power inrush, saves energy and increases compressor life

OPTIONS:

- Low/High Ambient
- Remote Controller
- Corrosion Protection
- Controller Programming
- Open Door Kill Switch
- Extended Temp. Probe
- Remote Control/Monitor
- Heater
- Dry Contact
- Custom Finish

Model	UL Type	BTU/Hour	Material	Voltage/Phase/Hz.	Running Amps	Max. Amb. Temp.	H x W x D	Unit Weight (lbs.)
CS01112612	12	1000	Powder coated steel	115/1/60	2.7	131°F	17" x 7" x 7"	31
CS01112604	4	1000	Powder coated steel	115/1/60	2.7	131°F	17" x 7" x 7"	31
CS0111264X	4X	1000	Stainless steel	115/1/60	2.7	131°F	17" x 7" x 7"	31
CS0111264XL4	4X	1000	Mill finish aluminum	115/1/60	2.7	131°F	17" x 7" x 7"	24

1000 BTUH | INDOOR/OUTDOOR, UL TYPES 12, 4 & 4X AVAILABLE

Engineered & manufactured to endure the most difficult of environments and applications.

Thermal Edge air conditioners will exceed environmental requirements in applications like Steel, Food Processing, Petro-Chemical, Cement, Paper & Pulp and Plastics



Digital Temperature Controller

- Programmable set point and temperature controls
- Visible Error and/or alarm messaging
- System status indication & keypad lockout function

Active Condensate Evaporation System

- Constant elimination of condensate
- Increases unit efficiency by pre-cooling refrigerant

Key Design Features

- Sloped top to allow for water runoff
- Designed with rigid chassis and seam welded shroud
- Thoughtful interior design for easy maintenance
- Narrow body style fits on 12" enclosure

Unit Efficiency

- Temperature operated condenser fan reduces power inrush and saves energy
- Highly efficient rotary compressor
- Fully insulated & sealed cabinet
- Thermal Expansion Valve to maintain cooling capacity over a broad ambient temperature range

Compressor Protection System

- High & Low refrigerant cutouts with fault indication
- Compressor anti short cycle protection
- Compressor run capacitors reduce power inrush, save energy and increase compressor life

OPTIONS:

- High Ambient
- Remote Controller
- Corrosion Protection
- Controller Programming
- Open Door Kill Switch
- Remote Control/Monitor
- Extended Temp. Probe
- Heater
- Dry Contact
- Custom Finish
- Diagnostics

Model	UL Type	BTU/Hour	Material	Voltage/Phase/Hz.	Running Amps	Max. Amb. Temp.	H x W x D	Unit Weight (lbs.)
NE01012612	12	1000	Powder coated steel	115/1/60	3.44	125°F	22" x 11.8" x 8.5"	51
NE01012604	4	1000	Powder coated steel	115/1/60	3.44	125°F	22" x 11.8" x 8.5"	51
NE0101264X	4X	1000	Stainless steel	115/1/60	3.44	125°F	22" x 11.8" x 8.5"	51
NE0101264XL4	4X	1000	Mill finish aluminum	115/1/60	3.44	125°F	22" x 11.8" x 8.5"	41
NE01023612	12	1000	Powder coated steel	230/1/60	2.67	125°F	22" x 11.8" x 8.5"	53
NE01023604	4	1000	Powder coated steel	230/1/60	2.67	125°F	22" x 11.8" x 8.5"	53
NE0102364X	4X	1000	Stainless steel	230/1/60	2.67	125°F	22" x 11.8" x 8.5"	53
NE0102364XL4	4X	1000	Mill finish aluminum	230/1/60	2.67	125°F	22" x 11.8" x 8.5"	43

1500 BTUH | INDOOR/OUTDOOR, UL TYPES 12, 4 & 4X AVAILABLE

Engineered & manufactured to endure the most difficult of environments and applications.

Thermal Edge air conditioners will exceed environmental requirements in applications like Steel, Food Processing, Petro-Chemical, Cement, Paper & Pulp and Plastics.



Digital Temperature Controller

- Programmable set point and temperature controls
- Visible Error and/or alarm messaging
- System status indication & keypad lockout function

Active Condensate Evaporation System

- Constant elimination of condensate
- Increases unit efficiency by pre-cooling refrigerant

Key Design Features

- Sloped top to allow for water runoff
- Designed with rigid chassis and seam welded shroud
- Thoughtful interior design for easy maintenance
- Narrow body style fits on 12" enclosure

Unit Efficiency

- Temperature operated condenser fan reduces power inrush and saves energy
- Highly efficient rotary compressor
- Fully insulated & sealed cabinet
- Thermal Expansion Valve to maintain cooling capacity over a broad ambient temperature range

Compressor Protection System

- High & Low refrigerant cutouts with fault indication
- Compressor anti short cycle protection
- Compressor run capacitors reduce power inrush, save energy and increase compressor life

OPTIONS:

- High Ambient
- Remote Controller
- Corrosion Protection
- Controller Programming
- Open Door Kill Switch
- Remote Control/Monitor
- Extended Temp. Probe
- Heater
- Dry Contact
- Custom Finish
- Diagnostics

Model	UL Type	BTU/Hour	Material	Voltage/ Phase/Hz.	Running Amps	Max. Amb. Temp.	H x W x D	Unit Weight (lbs.)
NE01512612	12	1500	Powder coated steel	115/1/60	3.44	125°F	22" x 11.8" x 8.5"	51
NE01512604	4	1500	Powder coated steel	115/1/60	3.44	125°F	22" x 11.8" x 8.5"	51
NE0151264X	4X	1500	Stainless steel	115/1/60	3.44	125°F	22" x 11.8" x 8.5"	51
NE0151264XL4	4X	1500	Mill finish aluminum	115/1/60	3.44	125°F	22" x 11.8" x 8.5"	41
NE01523612	12	1500	Powder coated steel	230/1/60	2.67	125°F	22" x 11.8" x 8.5"	53
NE01523604	4	1500	Powder coated steel	230/1/60	2.67	125°F	22" x 11.8" x 8.5"	53
NE0152364X	4X	1500	Stainless steel	230/1/60	2.67	125°F	22" x 11.8" x 8.5"	53
NE0152364XL4	4X	1500	Mill finish aluminum	230/1/60	2.67	125°F	22" x 11.8" x 8.5"	43

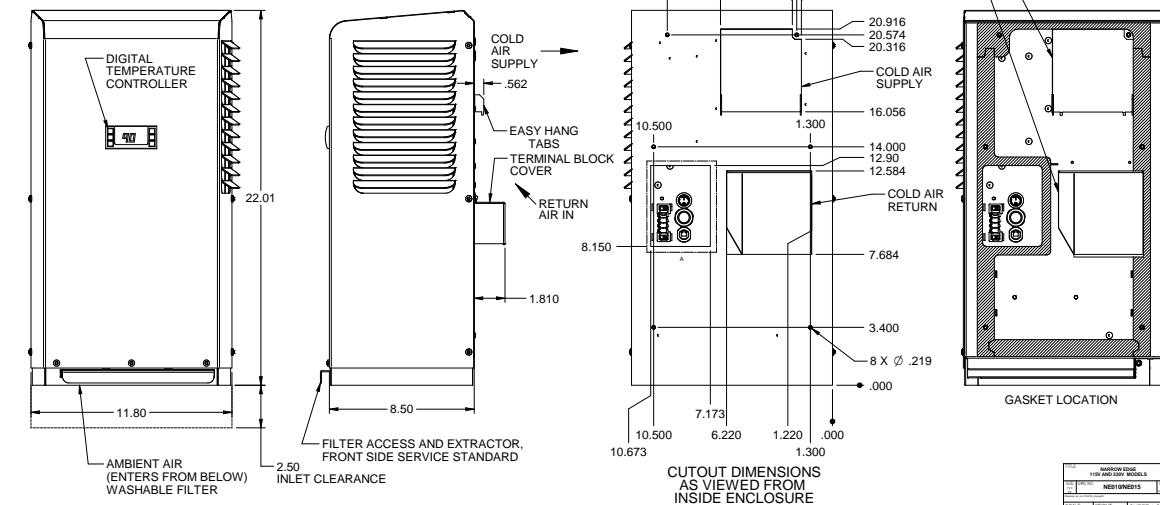
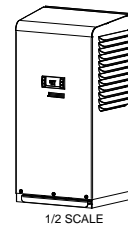
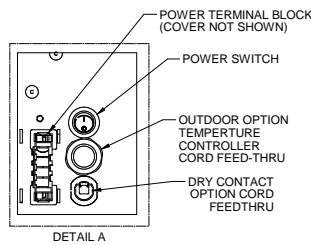
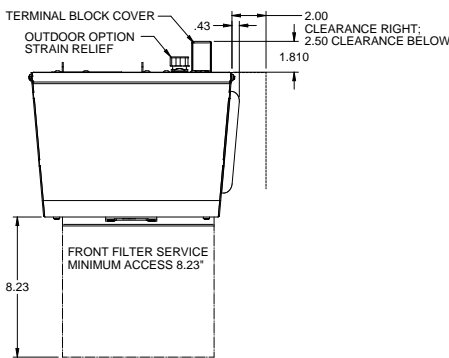
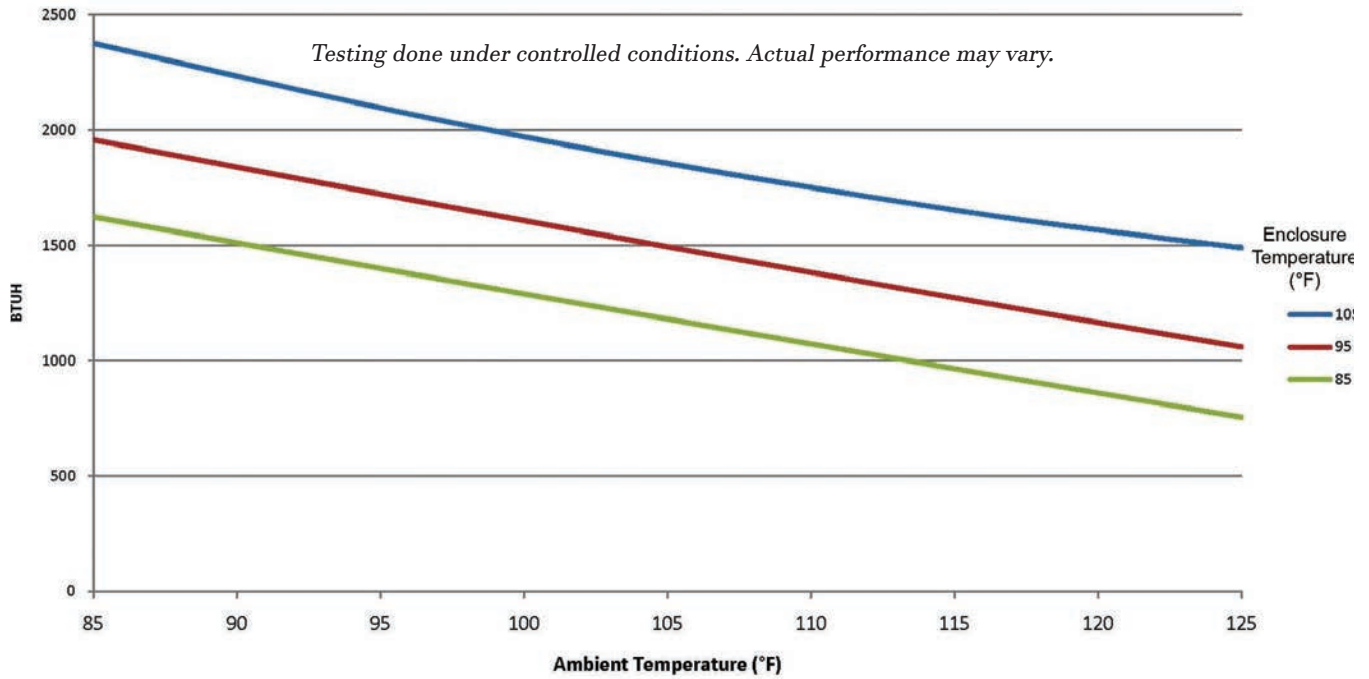

THERMAL EDGE	
MODEL	110V AND 220V MODELS
DATE	11/15/2015
BY	DESIGN
CHECK	REVISION
DATE	SHEET 1 OF 1

ATTENTION: If ordering a replacement for a Thermal Edge air conditioner, please include the part number and serial number of the unit being replaced in your order. This will ensure that we ship a replacement that is compatible with the cutout dimensions and power connection features of the older model. All information subject to change without notice.

2000 BTUH | INDOOR/OUTDOOR, UL TYPES 12, 4 & 4X AVAILABLE

Engineered & manufactured to endure the most difficult of environments and applications.

Thermal Edge air conditioners will exceed environmental requirements in applications like Steel, Food Processing, Petro-Chemical, Cement, Paper & Pulp and Plastics.



Digital Temperature Controller

- Programmable set point and temperature controls
- Visible Error and/or alarm messaging
- System status indication & keypad lockout function

Active Condensate Evaporation System

- Constant elimination of condensate
- Increases unit efficiency by pre-cooling refrigerant

Key Design Features

- Sloped top to allow for water runoff
- Designed with rigid chassis and seam welded shroud
- Thoughtful interior design for easy maintenance
- Narrow body style fits on 10" deep enclosure

Unit Efficiency

- Highly efficient rotary compressor
- Fully insulated & sealed cabinet
- Thermal Expansion Valve to maintain cooling capacity over a broad ambient temperature range

Compressor Protection System

- High & Low refrigerant cutouts with fault indication
- Compressor anti short cycle protection
- Thermal overload protector
- Compressor run capacitors reduce power inrush, save energy and increase compressor life

OPTIONS:

- Low/High Ambient
- Remote Controller
- Corrosion Protection
- Redundant System
- Controller Programming
- Open Door Kill Switch
- Remote Control/Monitor
- Extended Temp. Probe
- Heater
- Dry Contact
- Hazardous Location
- Filter/Filter Frame
- Custom Finish
- Diagnostics

Model	UL Type	BTU/Hour	Material	Voltage/ Phase/Hz.	Running Amps	Max. Amb. Temp.	H x W x D	Unit Weight (lbs.)
CS02012612	12	2000	Powder coated steel	115/1/60	4.1	131°F	20" x 10" x 10"	44
CS02012604	4	2000	Powder coated steel	115/1/60	4.1	131°F	20" x 10" x 10"	44
CS0201264X	4X	2000	Stainless steel	115/1/60	4.1	131°F	20" x 10" x 10"	44
CS0201264XL4	4X	2000	Mill finish aluminum	115/1/60	4.1	131°F	20" x 10" x 10"	34
CS02023612	12	2000	Powder coated steel	230/1/60	2.0	131°F	20" x 10" x 10"	49
CS02023604	4	2000	Powder coated steel	230/1/60	2.0	131°F	20" x 10" x 10"	49
CS0202364X	4X	2000	Stainless steel	230/1/60	2.0	131°F	20" x 10" x 10"	49
CS0202364XL4	4X	2000	Mill finish aluminum	230/1/60	2.0	131°F	20" x 10" x 10"	39

Testing done under controlled conditions. Actual performance may vary.

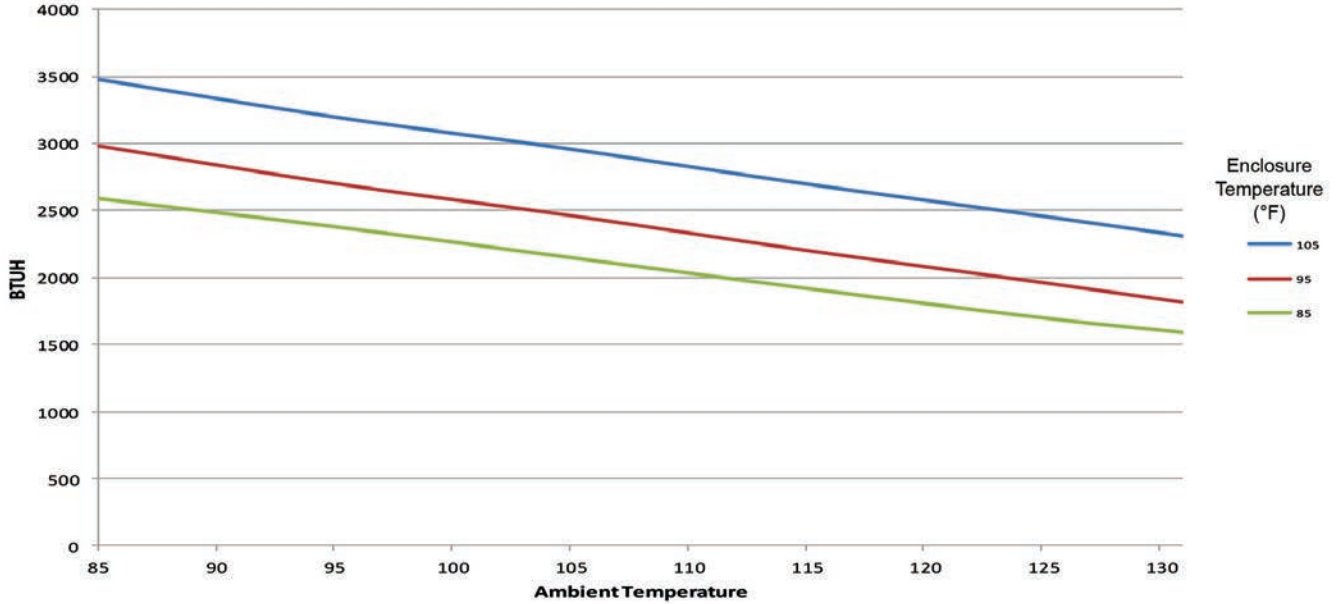

REVISIONS	
1	REVISED TO ADD 2" FILTER
2	REVISED TO ADD 2" FILTER
3	REVISED TO ADD 2" FILTER
4	REVISED TO ADD 2" FILTER

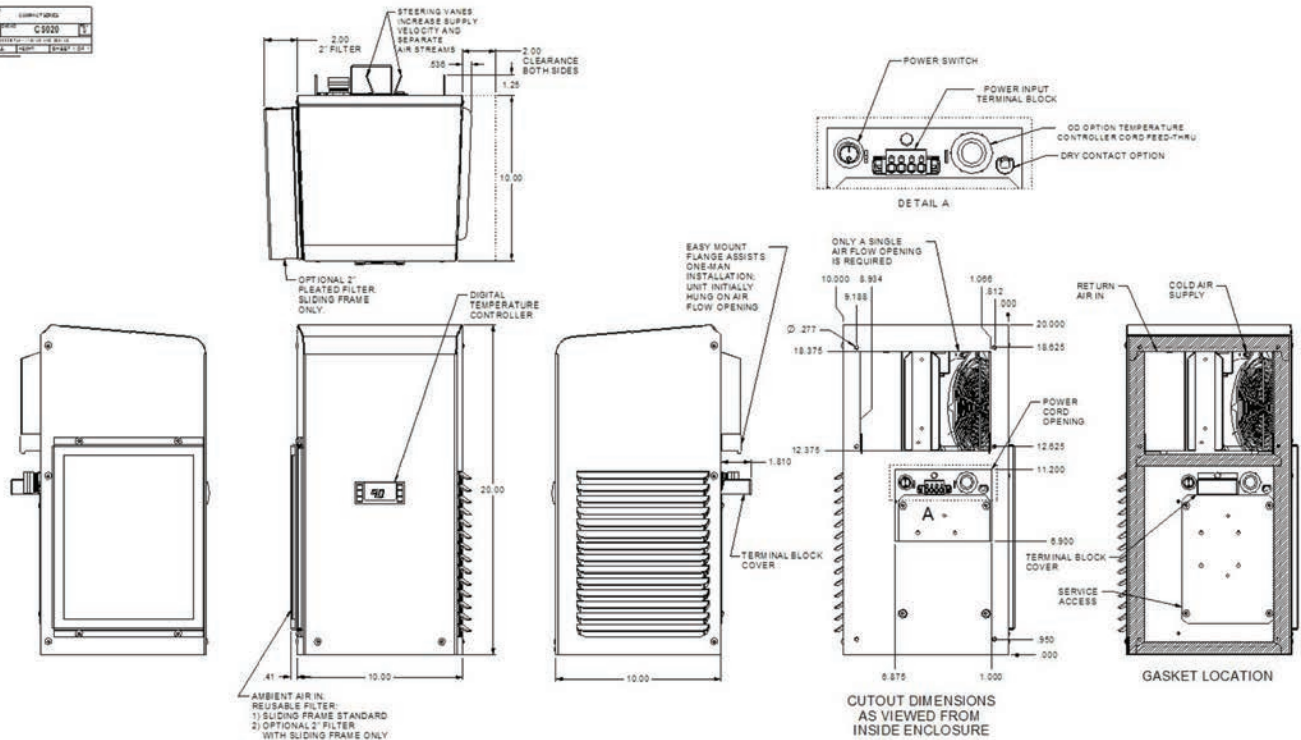

ATTENTION: If ordering a replacement for a Thermal Edge air conditioner, please include the part number and serial number of the unit being replaced in your order. This will ensure that we ship a replacement that is compatible with the cutout dimensions and power connection features of the older model. All information subject to change without notice.

**2000 BTUH 48 VOLT DC POWERED AIR CONDITIONER
INDOOR/OUTDOOR, UL TYPES 12, 4 & 4X AVAILABLE**

Engineered & manufactured to endure the most difficult of environments and applications. Thermal Edge air conditioners will exceed environmental requirements in applications like Telecom Outside Plant, Off-Grid Solar, Wind & other Battery Powered Electrical Cabinets.



Digital Temperature Controller

- Programmable set point and temperature controls
- Visible Error and/or alarm messaging
- System status indication & keypad lockout function

Active Condensate Evaporation System

- Constant elimination of condensate
- Increases unit efficiency by pre-cooling refrigerant

Key Design Features

- Sloped top to allow for water runoff
- Designed with rigid chassis and seam welded shroud
- Thoughtful interior design for easy maintenance
- Narrow body style fits on 12" enclosure

Unit Efficiency

- Temperature operated condenser fan reduces power inrush and saves energy
- Highly efficient rotary compressor
- Fully insulated & sealed cabinet
- Thermal Expansion Valve to maintain cooling capacity over a broad ambient temperature range

Compressor Protection System

- High & Low refrigerant cutouts with fault indication
- Compressor anti short cycle protection
- Thermal overload protector
- Compressor run capacitors reduce power inrush, save energy and increase compressor life

OPTIONS:

- High Ambient
- Remote Controller
- Corrosion Protection
- Redundant System
- Controller Programming
- Open Door Kill Switch
- Remote Control/Monitor
- Dry Contact
- Filter/Filter Frame
- Custom Finish
- Vibration Resistant
- Diagnostics

Model	UL Type	BTU/Hour	Material	Voltage	Running Amps	Max. Amb. Temp.	H x W x D	Unit Weight (lbs.)
NE020D4812	12	2000	Powder coated steel	48 VDC	5.7	131°F	35.27" x 11.8" x 9.5"	103
NE020D4804	4	2000	Powder coated steel	48 VDC	5.7	131°F	35.27" x 11.8" x 9.5"	103
NE020D484X	4X	2000	Stainless steel	48 VDC	5.7	131°F	35.27" x 11.8" x 9.5"	103
NE020D484XL6	4X	2000	Mill finish aluminum	48 VDC	5.7	131°F	35.27" x 11.8" x 9.5"	93

Testing done under controlled conditions. Actual performance may vary.

NE020D48

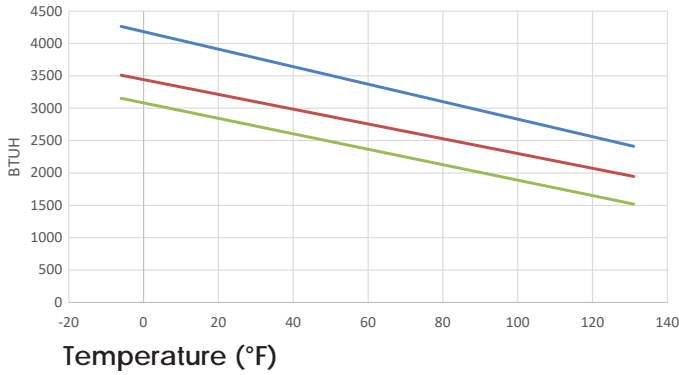

NE020D48 Running Amps

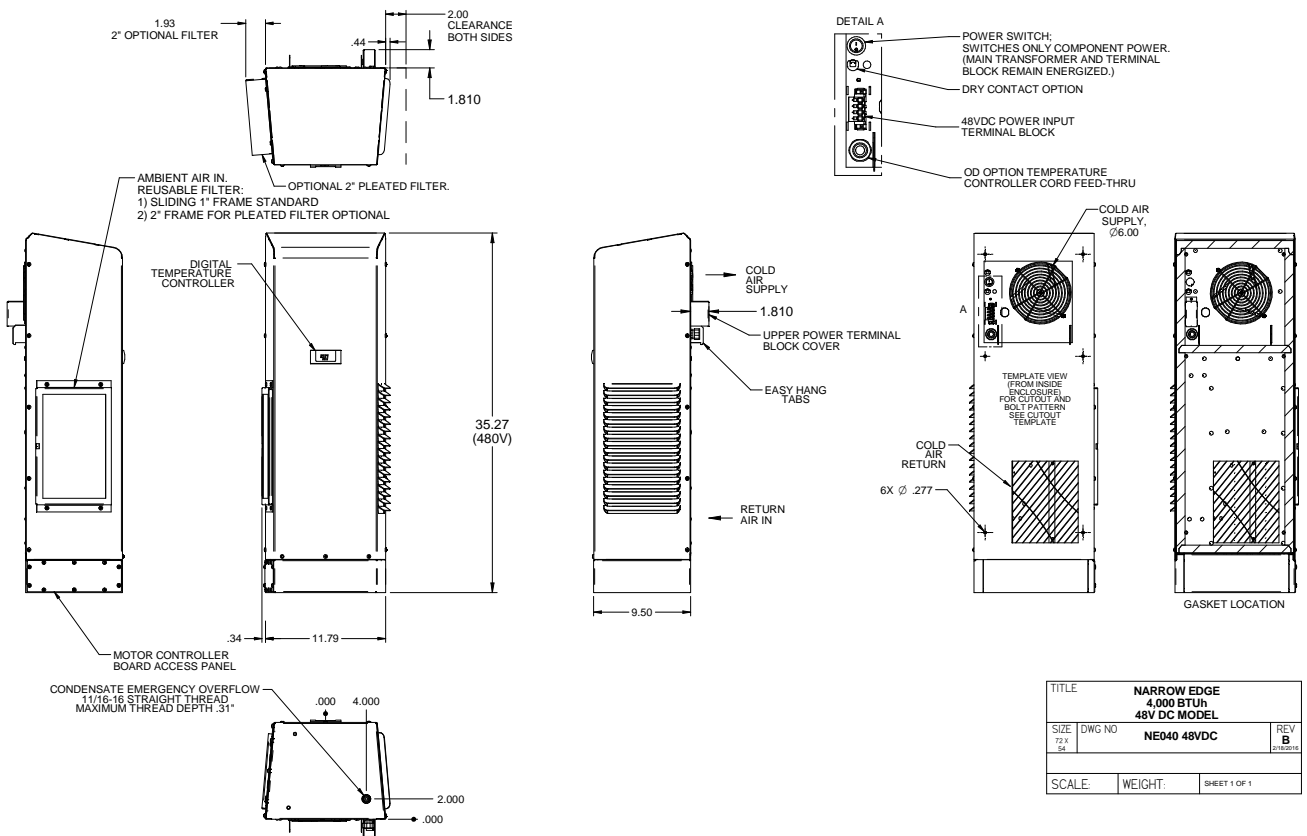
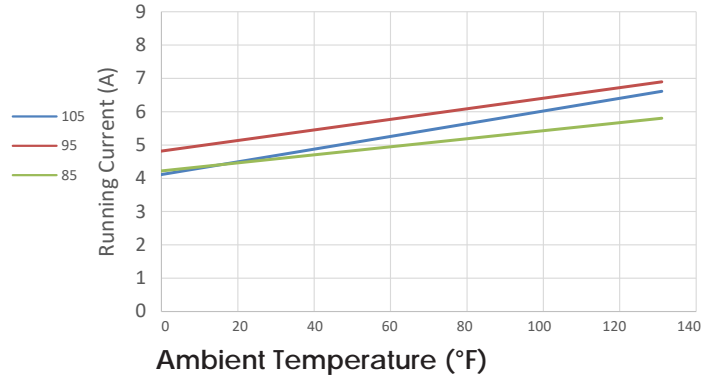

ATTENTION: If ordering a replacement for a Thermal Edge air conditioner, please include the part number and serial number of the unit being replaced in your order. This will ensure that we ship a replacement that is compatible with the cutout dimensions and power connection features of the older model. All information subject to change without notice.



2000 BTUH | INDOOR/OUTDOOR, UL TYPES 12, 4 & 4X AVAILABLE

Engineered & manufactured to endure the most difficult of environments and applications.

Thermal Edge air conditioners will exceed environmental requirements in applications like Steel, Food Processing, Petro-Chemical, Cement, Paper & Pulp and Plastics.



Digital Temperature Controller

- Programmable set point and temperature controls
- Visible Error and/or alarm messaging
- System status indication & keypad lockout function

Active Condensate Evaporation System

- Constant elimination of condensate
- Increases unit efficiency by pre-cooling refrigerant

Key Design Features

- Sloped top to allow for water runoff
- Designed with rigid chassis and seam welded shroud
- Thoughtful interior design for easy maintenance
- Narrow body style fits on 12" enclosure

Unit Efficiency

- Temperature operated condenser fan reduces power inrush and saves energy
- Highly efficient rotary compressor
- Fully insulated & sealed cabinet
- Thermal Expansion Valve to maintain cooling capacity over a broad ambient temperature range

Compressor Protection System

- High & Low refrigerant cutouts with fault indication
- Compressor anti short cycle protection
- Thermal overload protector
- Compressor run capacitors reduce power inrush, save energy and increase compressor life

OPTIONS:

- Low/High Ambient
- Remote Controller
- Corrosion Protection
- Open Door Kill Switch
- Redundant System
- Remote Control/Monitor
- Controller Programming
- Extended Temp. Probe
- Heater
- Dry Contact
- Hazardous Location
- Filter/Filter Frame
- Custom Finish
- Vibration Resistant

Model	UL Type	BTU/Hour	Material	Voltage/Phase/Hz.	Running Amps	Max. Amb. Temp.	H x W x D	Unit Weight (lbs.)
NE02012612	12	2000	Powder coated steel	115/1/60	3.3	134°F	32" x 11.8" x 9.5"	60
NE02012604	4	2000	Powder coated steel	115/1/60	3.3	134°F	32" x 11.8" x 9.5"	60
NE0201264X	4X	2000	Stainless steel	115/1/60	3.3	134°F	32" x 11.8" x 9.5"	60
NE0201264XL4	4X	2000	Mill finish aluminum	115/1/60	3.3	134°F	32" x 11.8" x 9.5"	50
NE02023612	12	2000	Powder coated steel	230/1/60	3.07	125°F	32" x 11.8" x 9.5"	72
NE02023604	4	2000	Powder coated steel	230/1/60	3.07	125°F	32" x 11.8" x 9.5"	72
NE0202364X	4X	2000	Stainless steel	230/1/60	3.07	125°F	32" x 11.8" x 9.5"	72
NE0202364XL4	4X	2000	Mill finish aluminum	230/1/60	3.07	125°F	32" x 11.8" x 9.5"	62
NE02048612	12	2000	Powder coated steel	460/1/60	0.87	134°F	38" x 11.8" x 9.5"	94
NE02048604	4	2000	Powder coated steel	460/1/60	0.87	134°F	38" x 11.8" x 9.5"	94
NE0204864X	4X	2000	Stainless steel	460/1/60	0.87	134°F	38" x 11.8" x 9.5"	94
NE0204864XL5	4X	2000	Mill finish aluminum	460/1/60	0.87	134°F	38" x 11.8" x 9.5"	84

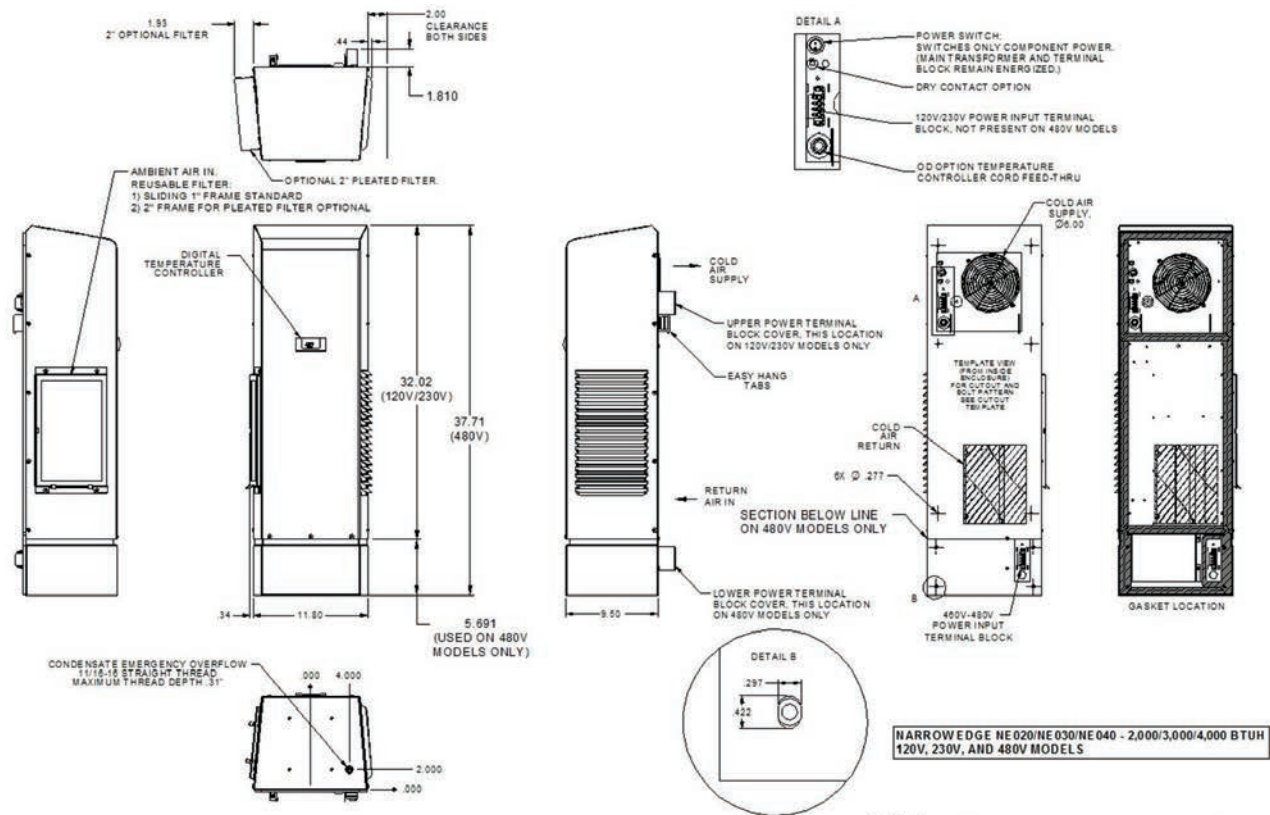
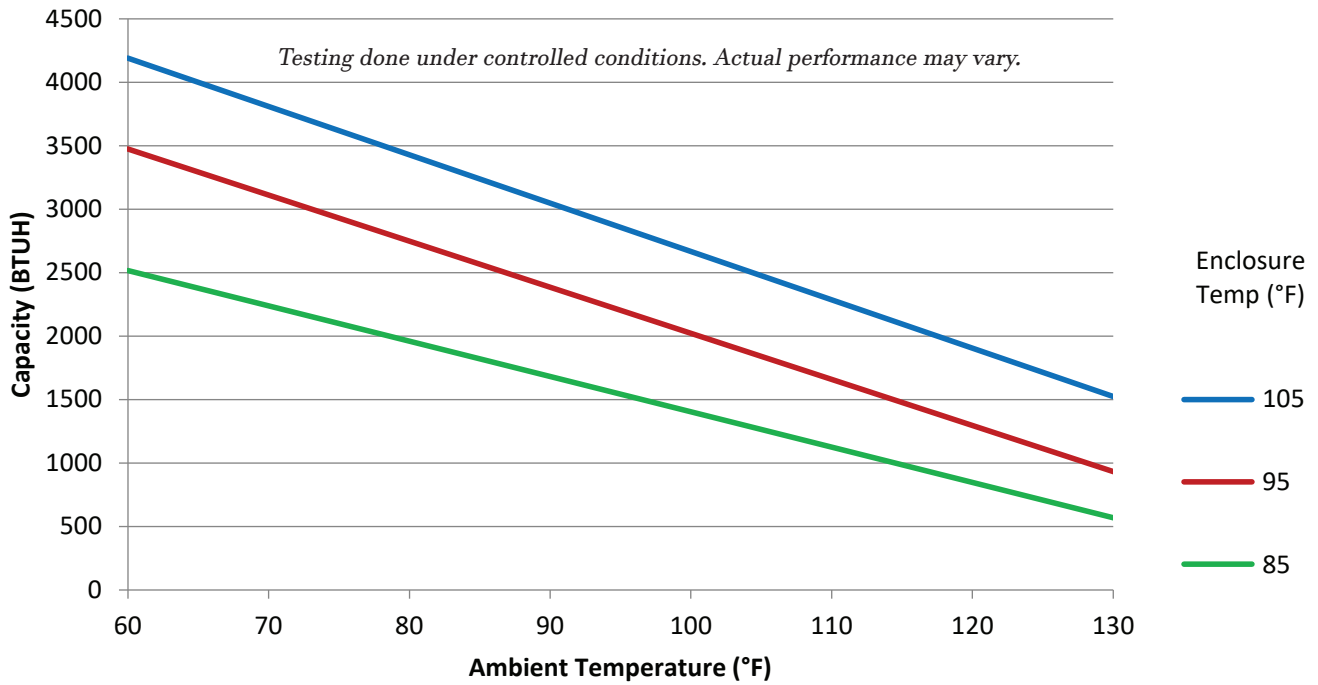

ATTENTION: If ordering a replacement for a Thermal Edge air conditioner, please include the part number and serial number of the unit being replaced in your order. This will ensure that we ship a replacement that is compatible with the cutout dimensions and power connection features of the older model. All information subject to change without notice.



2000 BTUH | INDOOR/OUTDOOR, UL TYPES 12, 4 & 4X AVAILABLE

Engineered & manufactured to endure the most difficult of environments and applications.

Thermal Edge air conditioners will exceed environmental requirements in applications like Steel, Food Processing, Petro-Chemical, Cement, Paper & Pulp and Plastics.



Digital Temperature Controller

- Programmable set point and temperature controls
- Visible Error and/or alarm messaging
- System status indication & keypad lockout function

Active Condensate Evaporation System

- Constant elimination of condensate
- Increases unit efficiency by pre-cooling refrigerant

Key Design Features

- Sloped top to allow for water runoff
- Designed with rigid chassis and seam welded shroud
- Thoughtful interior design for easy maintenance
- Narrow body style fits on 12" enclosure

Unit Efficiency

- Temperature operated condenser fan reduces power inrush and saves energy
- Highly efficient rotary compressor
- Fully insulated & sealed cabinet
- Thermal Expansion Valve to maintain cooling capacity over a broad ambient temperature range

Compressor Protection System

- High & Low refrigerant cutouts with fault indication
- Compressor anti short cycle protection
- Thermal overload protector
- Compressor run capacitors reduce power inrush, save energy and increase compressor life

OPTIONS:

- Low/High Ambient
- Remote Controller
- Corrosion Protection
- Redundant System
- Remote Control/Monitor
- Controller Programming
- Extended Temp. Probe
- Open Door Kill Switch
- Heater
- Dry Contact
- Hazardous Location
- Custom Finish
- Filter/Filter Frame
- Vibration Resistant

Model	UL Type	BTU/Hour	Material	Voltage/Phase/Hz.	Running Amps	Max. Amb. Temp.	H x W x D	Unit Weight (lbs.)
NE02S48612	12	2000	Powder coated steel	460/1/60	0.87	134°F	32.02" x 11.83" x 15.06"	94
NE02S48604	4	2000	Powder coated steel	460/1/60	0.87	134°F	32.02" x 11.83" x 15.06"	94
NE02S4864X	4X	2000	Stainless steel	460/1/60	0.87	134°F	32.02" x 11.83" x 15.06"	94
NE02S4864XL5	4X	2000	Mill finish aluminum	460/1/60	0.87	134°F	32.02" x 11.83" x 15.06"	84

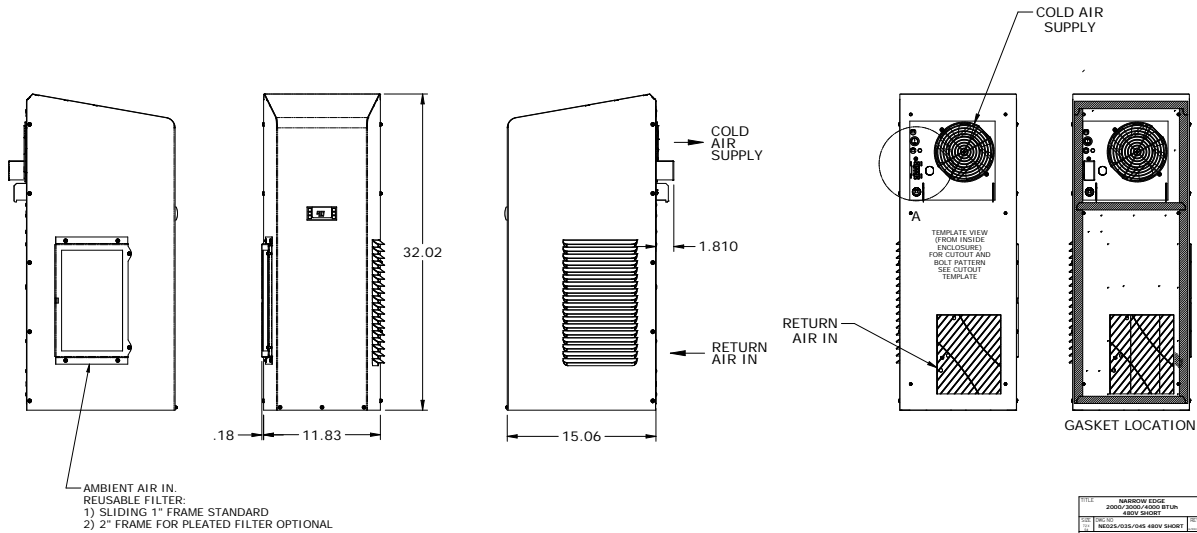
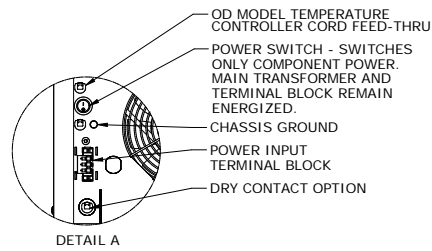
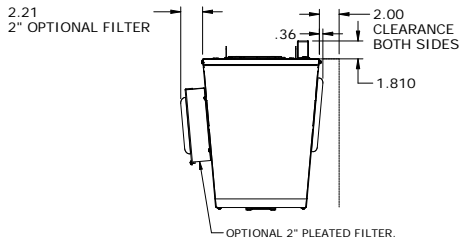
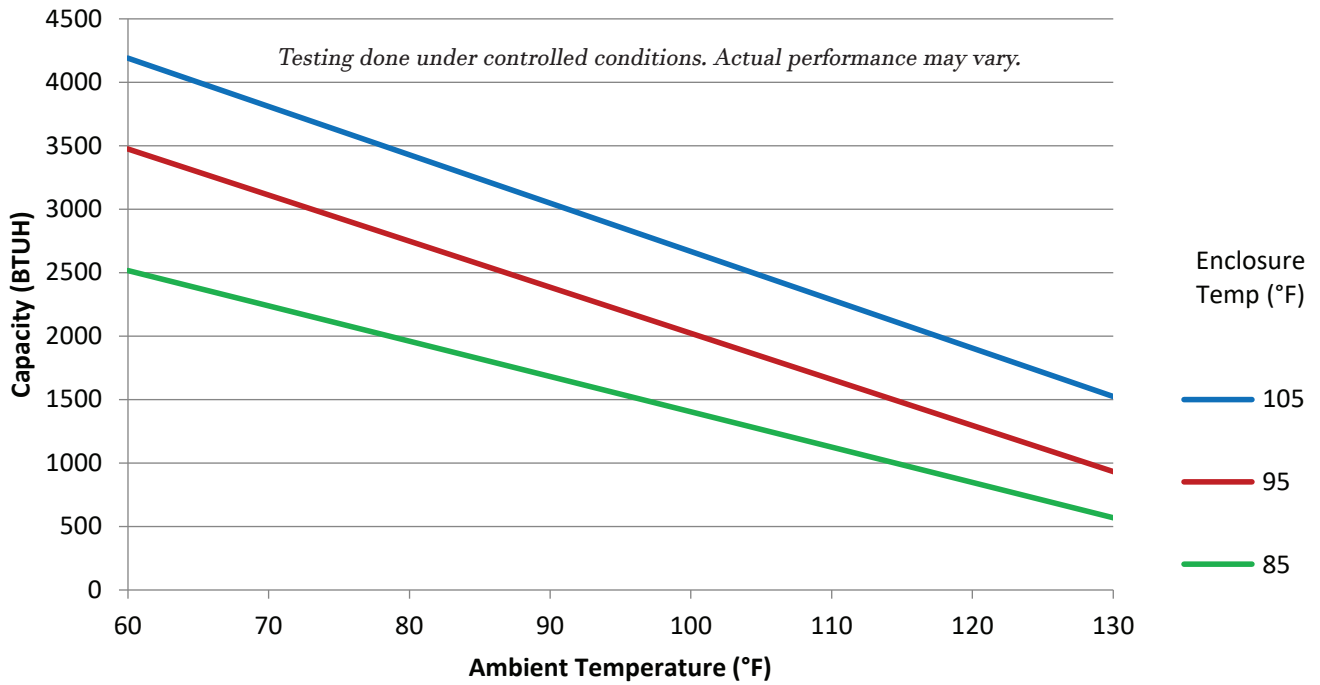

REV	DESCRIPTION	DATE
001	ISSUED	08/18/2024
002	REVISED	08/18/2024
003	REVISED	08/18/2024
004	REVISED	08/18/2024
005	REVISED	08/18/2024
006	REVISED	08/18/2024
007	REVISED	08/18/2024
008	REVISED	08/18/2024
009	REVISED	08/18/2024
010	REVISED	08/18/2024
011	REVISED	08/18/2024
012	REVISED	08/18/2024
013	REVISED	08/18/2024
014	REVISED	08/18/2024
015	REVISED	08/18/2024
016	REVISED	08/18/2024
017	REVISED	08/18/2024
018	REVISED	08/18/2024
019	REVISED	08/18/2024
020	REVISED	08/18/2024
021	REVISED	08/18/2024
022	REVISED	08/18/2024
023	REVISED	08/18/2024
024	REVISED	08/18/2024
025	REVISED	08/18/2024
026	REVISED	08/18/2024
027	REVISED	08/18/2024
028	REVISED	08/18/2024
029	REVISED	08/18/2024
030	REVISED	08/18/2024
031	REVISED	08/18/2024
032	REVISED	08/18/2024
033	REVISED	08/18/2024
034	REVISED	08/18/2024
035	REVISED	08/18/2024
036	REVISED	08/18/2024
037	REVISED	08/18/2024
038	REVISED	08/18/2024
039	REVISED	08/18/2024
040	REVISED	08/18/2024
041	REVISED	08/18/2024
042	REVISED	08/18/2024
043	REVISED	08/18/2024
044	REVISED	08/18/2024
045	REVISED	08/18/2024
046	REVISED	08/18/2024
047	REVISED	08/18/2024
048	REVISED	08/18/2024
049	REVISED	08/18/2024
050	REVISED	08/18/2024
051	REVISED	08/18/2024
052	REVISED	08/18/2024
053	REVISED	08/18/2024
054	REVISED	08/18/2024
055	REVISED	08/18/2024
056	REVISED	08/18/2024
057	REVISED	08/18/2024
058	REVISED	08/18/2024
059	REVISED	08/18/2024
060	REVISED	08/18/2024
061	REVISED	08/18/2024
062	REVISED	08/18/2024
063	REVISED	08/18/2024
064	REVISED	08/18/2024
065	REVISED	08/18/2024
066	REVISED	08/18/2024
067	REVISED	08/18/2024
068	REVISED	08/18/2024
069	REVISED	08/18/2024
070	REVISED	08/18/2024
071	REVISED	08/18/2024
072	REVISED	08/18/2024
073	REVISED	08/18/2024
074	REVISED	08/18/2024
075	REVISED	08/18/2024
076	REVISED	08/18/2024
077	REVISED	08/18/2024
078	REVISED	08/18/2024
079	REVISED	08/18/2024
080	REVISED	08/18/2024
081	REVISED	08/18/2024
082	REVISED	08/18/2024
083	REVISED	08/18/2024
084	REVISED	08/18/2024
085	REVISED	08/18/2024
086	REVISED	08/18/2024
087	REVISED	08/18/2024
088	REVISED	08/18/2024
089	REVISED	08/18/2024
090	REVISED	08/18/2024
091	REVISED	08/18/2024
092	REVISED	08/18/2024
093	REVISED	08/18/2024
094	REVISED	08/18/2024
095	REVISED	08/18/2024
096	REVISED	08/18/2024
097	REVISED	08/18/2024
098	REVISED	08/18/2024
099	REVISED	08/18/2024
100	REVISED	08/18/2024



ATTENTION: If ordering a replacement for a Thermal Edge air conditioner, please include the part number and serial number of the unit being replaced in your order. This will ensure that we ship a replacement that is compatible with the cutout dimensions and power connection features of the older model. All information subject to change without notice.

**3000 BTUH 48 VOLT DC POWERED AIR CONDITIONER
INDOOR/OUTDOOR, UL TYPES 12, 4 & 4X AVAILABLE**

Engineered & manufactured to endure the most difficult of environments and applications. Thermal Edge air conditioners will exceed environmental requirements in applications like Telecom Outside Plant, Off-Grid Solar, Wind & other Battery Powered Electrical Cabinets.



Digital Temperature Controller

- Programmable set point and temperature controls
- Visible Error and/or alarm messaging
- System status indication & keypad lockout function

Active Condensate Evaporation System

- Constant elimination of condensate
- Increases unit efficiency by pre-cooling refrigerant

Key Design Features

- Sloped top to allow for water runoff
- Designed with rigid chassis and seam welded shroud
- Thoughtful interior design for easy maintenance
- Narrow body style fits on 12" enclosure

Unit Efficiency

- Temperature operated condenser fan reduces power inrush and saves energy
- Highly efficient rotary compressor
- Fully insulated & sealed cabinet
- Thermal Expansion Valve to maintain cooling capacity over a broad ambient temperature range

Compressor Protection System

- High & Low refrigerant cutouts with fault indication
- Compressor anti short cycle protection
- Thermal overload protector
- Compressor run capacitors reduce power inrush, save energy and increase compressor life

OPTIONS:

- High Ambient
- Remote Controller
- Corrosion Protection
- Redundant System
- Remote Control/Monitor
- Controller Programming
- Extended Temp. Probe
- Open Door Kill Switch
- Dry Contact
- Custom Finish
- Filter/Filter Frame
- Vibration Resistant
- Diagnostics

Model	UL Type	BTU/Hour	Material	Voltage	Running Amps	Max. Amb. Temp.	H x W x D	Unit Weight (lbs.)
NE030D4812	12	3000	Powder coated steel	48 VDC	8.7	131°F	35.27" x 11.8" x 9.5"	103
NE030D4804	4	3000	Powder coated steel	48 VDC	8.7	131°F	35.27" x 11.8" x 9.5"	103
NE030D484X	4X	3000	Stainless steel	48 VDC	8.7	131°F	35.27" x 11.8" x 9.5"	103
NE030D484XL6	4X	3000	Mill finish aluminum	48 VDC	8.7	131°F	35.27" x 11.8" x 9.5"	93

Testing done under controlled conditions. Actual performance may vary.

NE030D48

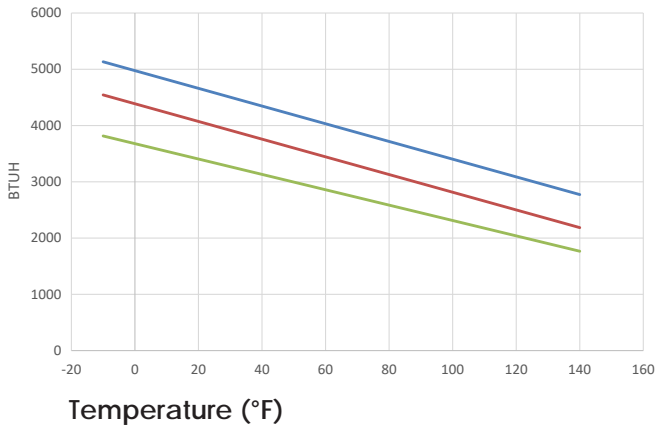

NE030D48 Running Amps

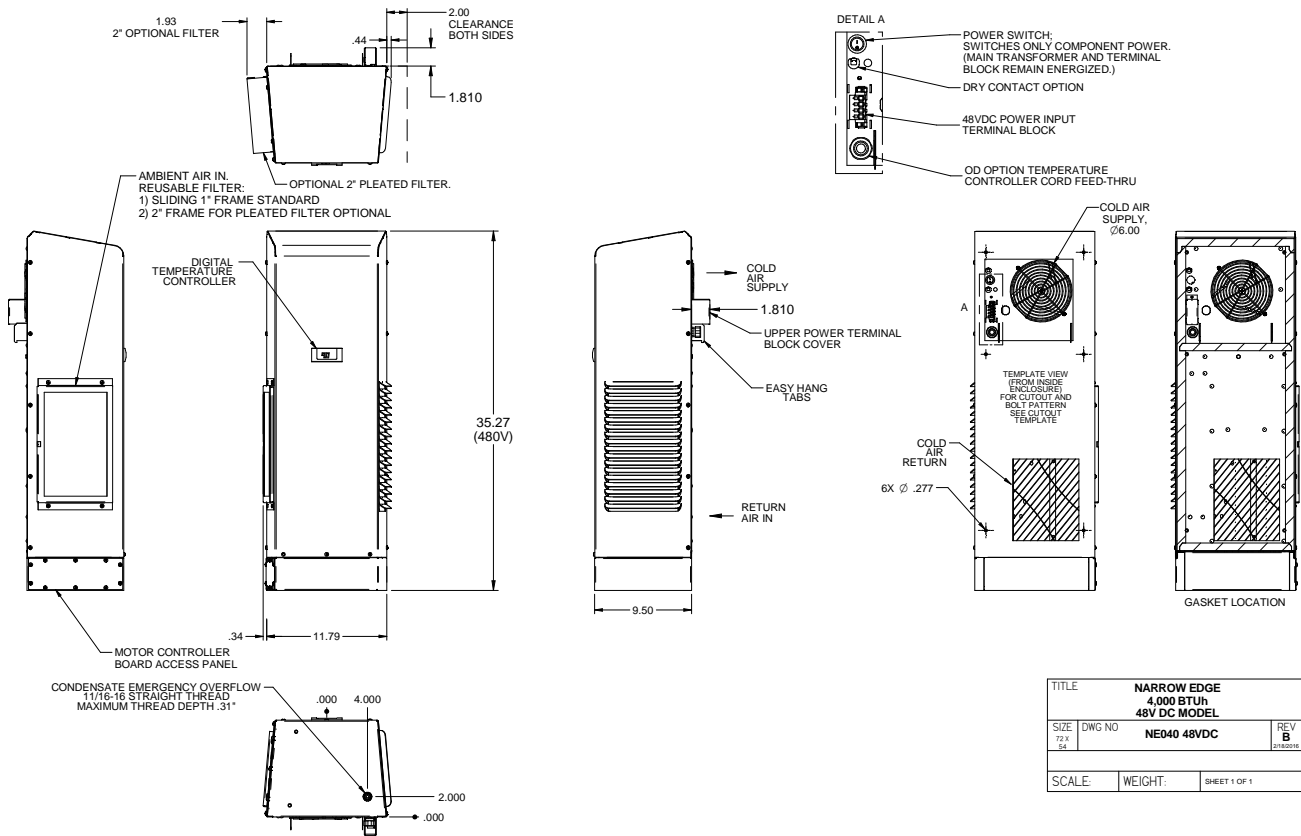
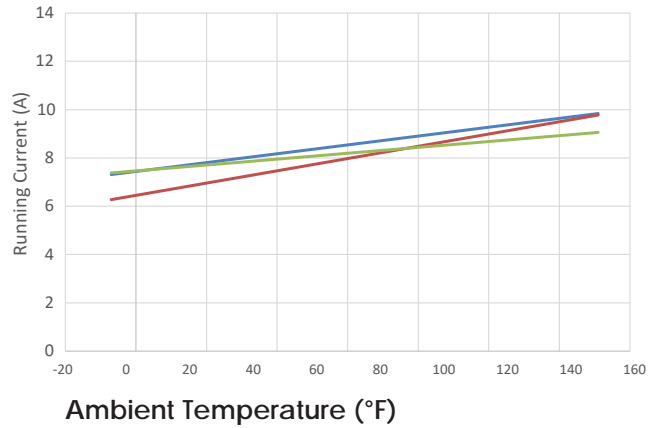

ATTENTION: If ordering a replacement for a Thermal Edge air conditioner, please include the part number and serial number of the unit being replaced in your order. This will ensure that we ship a replacement that is compatible with the cutout dimensions and power connection features of the older model. All information subject to change without notice.

3000 BTUH | INDOOR/OUTDOOR, UL TYPES 12, 4 & 4X AVAILABLE

Engineered & manufactured to endure the most difficult of environments and applications.

Thermal Edge air conditioners will exceed environmental requirements in applications like Steel, Food Processing, Petro-Chemical, Cement, Paper & Pulp and Plastics.



Digital Temperature Controller

- Programmable set point and temperature controls
- Visible Error and/or alarm messaging
- System status indication & keypad lockout function

Active Condensate Evaporation System

- Constant elimination of condensate
- Increases unit efficiency by pre-cooling refrigerant

Key Design Features

- Sloped top to allow for water runoff
- Designed with rigid chassis and seam welded shroud
- Thoughtful interior design for easy maintenance
- Narrow body style fits on 12" enclosure

Unit Efficiency

- Temperature operated condenser fan reduces power inrush and saves energy
- Highly efficient rotary compressor
- Fully insulated & sealed cabinet
- Thermal Expansion Valve to maintain cooling capacity over a broad ambient temperature range

Compressor Protection System

- High & Low refrigerant cutouts with fault indication
- Compressor anti short cycle protection
- Thermal overload protector
- Compressor run capacitors reduce power inrush, save energy and increase compressor life

OPTIONS:

- Low/High Ambient
- Remote Controller
- Corrosion Protection
- Redundant System
- Remote Control/Monitor
- Controller Programming
- Open Door Kill Switch
- Extended Temp. Probe
- Heater
- Dry Contact
- Hazardous Location
- Custom Finish
- Filter/Filter Frame
- Vibration Resistant

Model	UL Type	BTU/Hour	Material	Voltage/Phase/Hz.	Running Amps	Max. Amb. Temp.	H x W x D	Unit Weight (lbs.)
NE03012612	12	3000	Powder coated steel	115/1/60	4.86	140°F	32" x 11.8" x 9.5"	70
NE03012604	4	3000	Powder coated steel	115/1/60	4.86	140°F	32" x 11.8" x 9.5"	70
NE0301264X	4X	3000	Stainless steel	115/1/60	4.86	140°F	32" x 11.8" x 9.5"	70
NE0301264XL4	4X	3000	Mill finish aluminum	115/1/60	4.86	140°F	32" x 11.8" x 9.5"	60
NE03023612	12	3000	Powder coated steel	230/1/60	3.07	125°F	32" x 11.8" x 9.5"	72
NE03023604	4	3000	Powder coated steel	230/1/60	3.07	125°F	32" x 11.8" x 9.5"	72
NE0302364X	4X	3000	Stainless steel	230/1/60	3.07	125°F	32" x 11.8" x 9.5"	72
NE0302364XL4	4X	3000	Mill finish aluminum	230/1/60	3.07	125°F	32" x 11.8" x 9.5"	62
NE03048612	12	3000	Powder coated steel	460/1/60	1.28	140°F	38" x 11.8" x 9.5"	103
NE03048604	4	3000	Powder coated steel	460/1/60	1.28	140°F	38" x 11.8" x 9.5"	103
NE0304864X	4X	3000	Stainless steel	460/1/60	1.28	140°F	38" x 11.8" x 9.5"	103
NE0304864XL5	4X	3000	Mill finish aluminum	460/1/60	1.28	140°F	38" x 11.8" x 9.5"	93

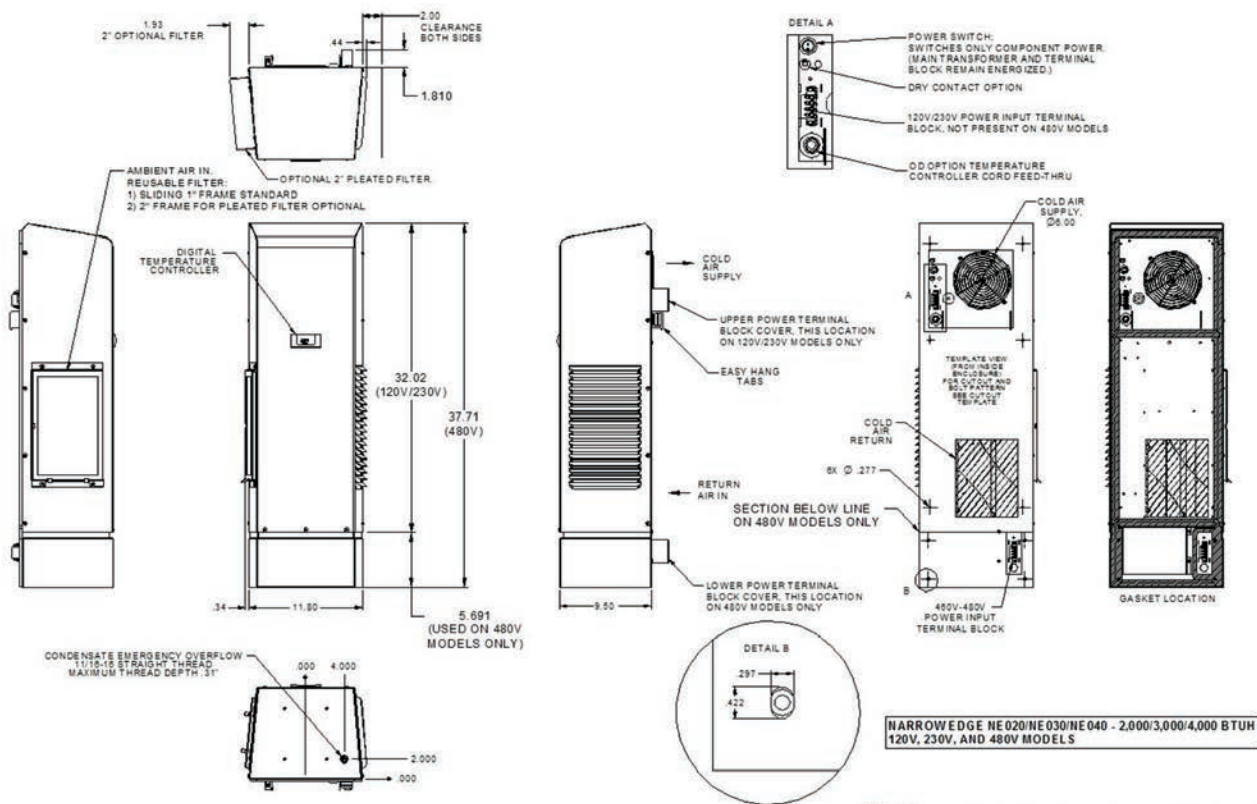
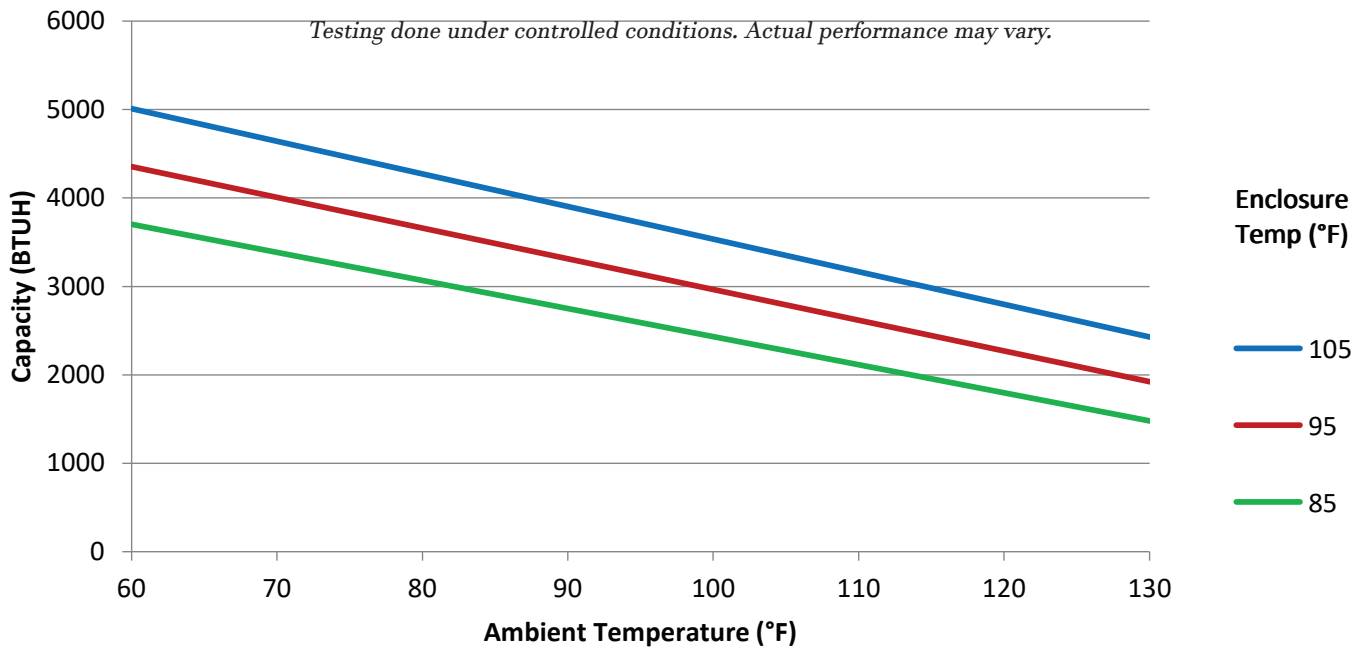

ATTENTION: If ordering a replacement for a Thermal Edge air conditioner, please include the part number and serial number of the unit being replaced in your order. This will ensure that we ship a replacement that is compatible with the cutout dimensions and power connection features of the older model. All information subject to change without notice.

3000 BTUH | INDOOR/OUTDOOR, UL TYPES 12, 4 & 4X AVAILABLE

Engineered & manufactured to endure the most difficult of environments and applications.

Thermal Edge air conditioners will exceed environmental requirements in applications like Steel, Food Processing, Petro-Chemical, Cement, Paper & Pulp and Plastics.



Digital Temperature Controller

- Programmable set point and temperature controls
- Visible Error and/or alarm messaging
- System status indication & keypad lockout function

Active Condensate Evaporation System

- Constant elimination of condensate
- Increases unit efficiency by pre-cooling refrigerant

Key Design Features

- Sloped top to allow for water runoff
- Designed with rigid chassis and seam welded shroud
- Thoughtful interior design for easy maintenance
- Narrow body style fits on 12" enclosure

Unit Efficiency

- Temperature operated condenser fan reduces power inrush and saves energy
- Highly efficient rotary compressor
- Fully insulated & sealed cabinet
- Thermal Expansion Valve to maintain cooling capacity over a broad ambient temperature range

Compressor Protection System

- High & Low refrigerant cutouts with fault indication
- Compressor anti short cycle protection
- Thermal overload protector
- Compressor run capacitors reduce power inrush, save energy and increase compressor life

OPTIONS:

- Low/High Ambient
- Remote Controller
- Corrosion Protection
- Redundant System
- Remote Control/Monitor
- Controller Programming
- Open Door Kill Switch
- Extended Temp. Probe
- Heater
- Dry Contact
- Hazardous Location
- Custom Finish
- Filter/Filter Frame
- Vibration Resistant

Model	UL Type	BTU/Hour	Material	Voltage/Phase/Hz.	Running Amps	Max. Amb. Temp.	H x W x D	Unit Weight (lbs.)
NE03S48612	12	3000	Powder coated steel	460/1/60	1.28	140°F	32.02" x 11.83" x 15.06"	103
NE03S48604	4	3000	Powder coated steel	460/1/60	1.28	140°F	32.02" x 11.83" x 15.06"	103
NE03S4864X	4X	3000	Stainless steel	460/1/60	1.28	140°F	32.02" x 11.83" x 15.06"	103
NE03S486XL5	4X	3000	Mill finish aluminum	460/1/60	1.28	140°F	32.02" x 11.83" x 15.06"	93

Testing done under controlled conditions. Actual performance may vary.

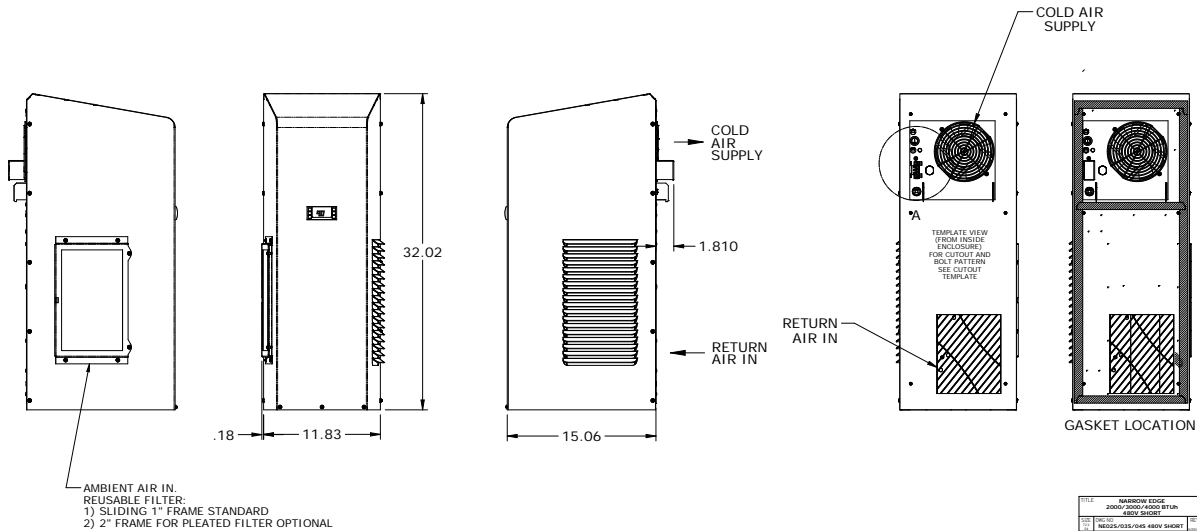
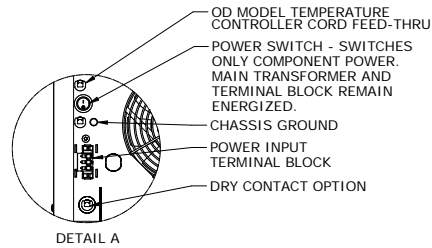
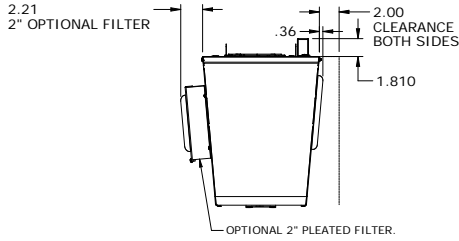
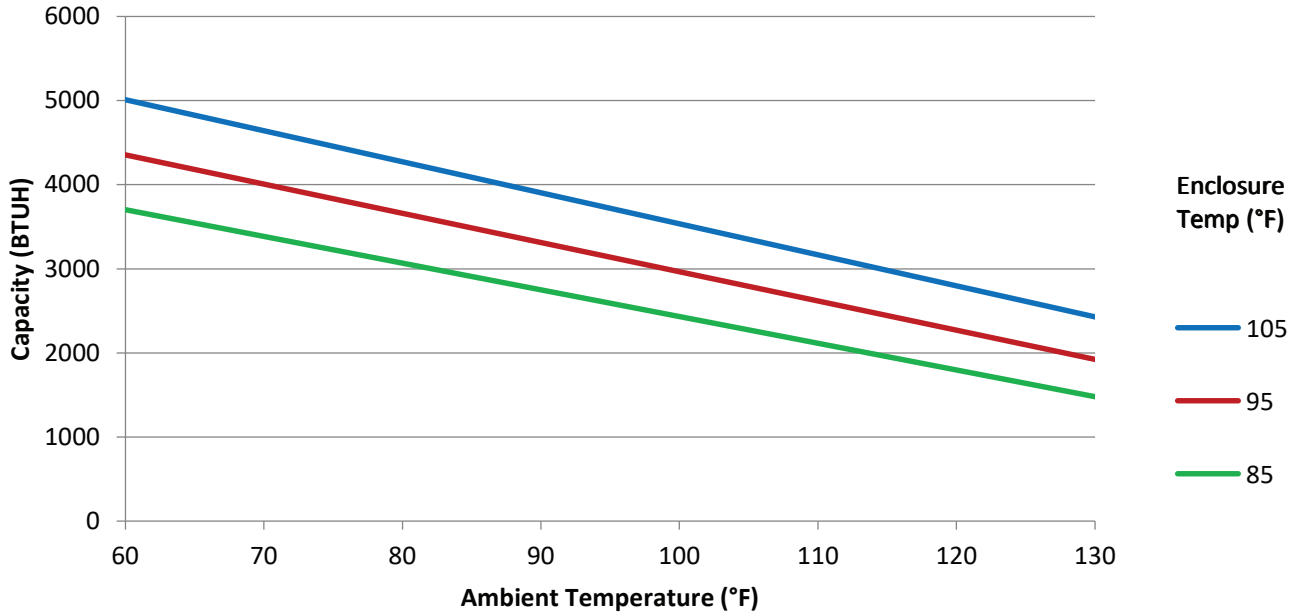

REV	DESCRIPTION
001	MINOR EDGE 2000/3000/4000 BTUH 400V SHORT
002	1000/2000/3000 BTUH 208V SHORT
003	1000/2000/3000 BTUH 208V SHORT
004	1000/2000/3000 BTUH 208V SHORT
005	1000/2000/3000 BTUH 208V SHORT
006	1000/2000/3000 BTUH 208V SHORT
007	1000/2000/3000 BTUH 208V SHORT
008	1000/2000/3000 BTUH 208V SHORT
009	1000/2000/3000 BTUH 208V SHORT
010	1000/2000/3000 BTUH 208V SHORT
011	1000/2000/3000 BTUH 208V SHORT
012	1000/2000/3000 BTUH 208V SHORT
013	1000/2000/3000 BTUH 208V SHORT
014	1000/2000/3000 BTUH 208V SHORT
015	1000/2000/3000 BTUH 208V SHORT
016	1000/2000/3000 BTUH 208V SHORT
017	1000/2000/3000 BTUH 208V SHORT
018	1000/2000/3000 BTUH 208V SHORT
019	1000/2000/3000 BTUH 208V SHORT
020	1000/2000/3000 BTUH 208V SHORT
021	1000/2000/3000 BTUH 208V SHORT
022	1000/2000/3000 BTUH 208V SHORT
023	1000/2000/3000 BTUH 208V SHORT
024	1000/2000/3000 BTUH 208V SHORT
025	1000/2000/3000 BTUH 208V SHORT
026	1000/2000/3000 BTUH 208V SHORT
027	1000/2000/3000 BTUH 208V SHORT
028	1000/2000/3000 BTUH 208V SHORT
029	1000/2000/3000 BTUH 208V SHORT
030	1000/2000/3000 BTUH 208V SHORT
031	1000/2000/3000 BTUH 208V SHORT
032	1000/2000/3000 BTUH 208V SHORT
033	1000/2000/3000 BTUH 208V SHORT
034	1000/2000/3000 BTUH 208V SHORT
035	1000/2000/3000 BTUH 208V SHORT
036	1000/2000/3000 BTUH 208V SHORT
037	1000/2000/3000 BTUH 208V SHORT
038	1000/2000/3000 BTUH 208V SHORT
039	1000/2000/3000 BTUH 208V SHORT
040	1000/2000/3000 BTUH 208V SHORT
041	1000/2000/3000 BTUH 208V SHORT
042	1000/2000/3000 BTUH 208V SHORT
043	1000/2000/3000 BTUH 208V SHORT
044	1000/2000/3000 BTUH 208V SHORT
045	1000/2000/3000 BTUH 208V SHORT
046	1000/2000/3000 BTUH 208V SHORT
047	1000/2000/3000 BTUH 208V SHORT
048	1000/2000/3000 BTUH 208V SHORT
049	1000/2000/3000 BTUH 208V SHORT
050	1000/2000/3000 BTUH 208V SHORT
051	1000/2000/3000 BTUH 208V SHORT
052	1000/2000/3000 BTUH 208V SHORT
053	1000/2000/3000 BTUH 208V SHORT
054	1000/2000/3000 BTUH 208V SHORT
055	1000/2000/3000 BTUH 208V SHORT
056	1000/2000/3000 BTUH 208V SHORT
057	1000/2000/3000 BTUH 208V SHORT
058	1000/2000/3000 BTUH 208V SHORT
059	1000/2000/3000 BTUH 208V SHORT
060	1000/2000/3000 BTUH 208V SHORT
061	1000/2000/3000 BTUH 208V SHORT
062	1000/2000/3000 BTUH 208V SHORT
063	1000/2000/3000 BTUH 208V SHORT
064	1000/2000/3000 BTUH 208V SHORT
065	1000/2000/3000 BTUH 208V SHORT
066	1000/2000/3000 BTUH 208V SHORT
067	1000/2000/3000 BTUH 208V SHORT
068	1000/2000/3000 BTUH 208V SHORT
069	1000/2000/3000 BTUH 208V SHORT
070	1000/2000/3000 BTUH 208V SHORT
071	1000/2000/3000 BTUH 208V SHORT
072	1000/2000/3000 BTUH 208V SHORT
073	1000/2000/3000 BTUH 208V SHORT
074	1000/2000/3000 BTUH 208V SHORT
075	1000/2000/3000 BTUH 208V SHORT
076	1000/2000/3000 BTUH 208V SHORT
077	1000/2000/3000 BTUH 208V SHORT
078	1000/2000/3000 BTUH 208V SHORT
079	1000/2000/3000 BTUH 208V SHORT
080	1000/2000/3000 BTUH 208V SHORT
081	1000/2000/3000 BTUH 208V SHORT
082	1000/2000/3000 BTUH 208V SHORT
083	1000/2000/3000 BTUH 208V SHORT
084	1000/2000/3000 BTUH 208V SHORT
085	1000/2000/3000 BTUH 208V SHORT
086	1000/2000/3000 BTUH 208V SHORT
087	1000/2000/3000 BTUH 208V SHORT
088	1000/2000/3000 BTUH 208V SHORT
089	1000/2000/3000 BTUH 208V SHORT
090	1000/2000/3000 BTUH 208V SHORT
091	1000/2000/3000 BTUH 208V SHORT
092	1000/2000/3000 BTUH 208V SHORT
093	1000/2000/3000 BTUH 208V SHORT
094	1000/2000/3000 BTUH 208V SHORT
095	1000/2000/3000 BTUH 208V SHORT
096	1000/2000/3000 BTUH 208V SHORT
097	1000/2000/3000 BTUH 208V SHORT
098	1000/2000/3000 BTUH 208V SHORT
099	1000/2000/3000 BTUH 208V SHORT
100	1000/2000/3000 BTUH 208V SHORT



ATTENTION: If ordering a replacement for a Thermal Edge air conditioner, please include the part number and serial number of the unit being replaced in your order. This will ensure that we ship a replacement that is compatible with the cutout dimensions and power connection features of the older model. All information subject to change without notice.

**4000 BTUH 48 VOLT DC POWERED AIR CONDITIONER
INDOOR/OUTDOOR, UL TYPES 12, 4 & 4X AVAILABLE**

Engineered & manufactured to endure the most difficult of environments and applications. Thermal Edge air conditioners will exceed environmental requirements in applications like Telecom Outside Plant, Off-Grid Solar, Wind & other Battery Powered Electrical Cabinets.



Digital Temperature Controller

- Programmable set point and temperature controls
- Visible Error and/or alarm messaging
- System status indication & keypad lockout function

Active Condensate Evaporation System

- Constant elimination of condensate
- Increases unit efficiency by pre-cooling refrigerant

Key Design Features

- Sloped top to allow for water runoff
- Designed with rigid chassis and seam welded shroud
- Thoughtful interior design for easy maintenance
- Narrow body style fits on 12" enclosure

Unit Efficiency

- Temperature operated condenser fan reduces power inrush and saves energy
- Highly efficient rotary compressor
- Fully insulated & sealed cabinet
- Thermal Expansion Valve to maintain cooling capacity over a broad ambient temperature range

Compressor Protection System

- High & Low refrigerant cutouts with fault indication
- Compressor anti short cycle protection
- Thermal overload protector
- Compressor run capacitors reduce power inrush, save energy and increase compressor life

OPTIONS:

- High Ambient
- Remote Controller
- Corrosion Protection
- Redundant System
- Remote Control/Monitor
- Controller Programming
- Open Door Kill Switch
- Extended Temp. Probe
- Dry Contact
- Custom Finish
- Filter/Filter Frame
- Vibration Resistant
- Diagnostics

Model	UL Type	BTU/Hour	Material	Voltage	Running Amps	Max. Amb. Temp.	H x W x D	Unit Weight (lbs.)
NE040D4812	12	4000	Powder coated steel	48 VDC	17.5	131°F	35.27" x 11.8" x 9.5"	103
NE040D4804	4	4000	Powder coated steel	48 VDC	17.5	131°F	35.27" x 11.8" x 9.5"	103
NE040D484X	4X	4000	Stainless steel	48 VDC	17.5	131°F	35.27" x 11.8" x 9.5"	103
NE040D484XL6	4X	4000	Mill finish aluminum	48 VDC	17.5	131°F	35.27" x 11.8" x 9.5"	93

Testing done under controlled conditions. Actual performance may vary.

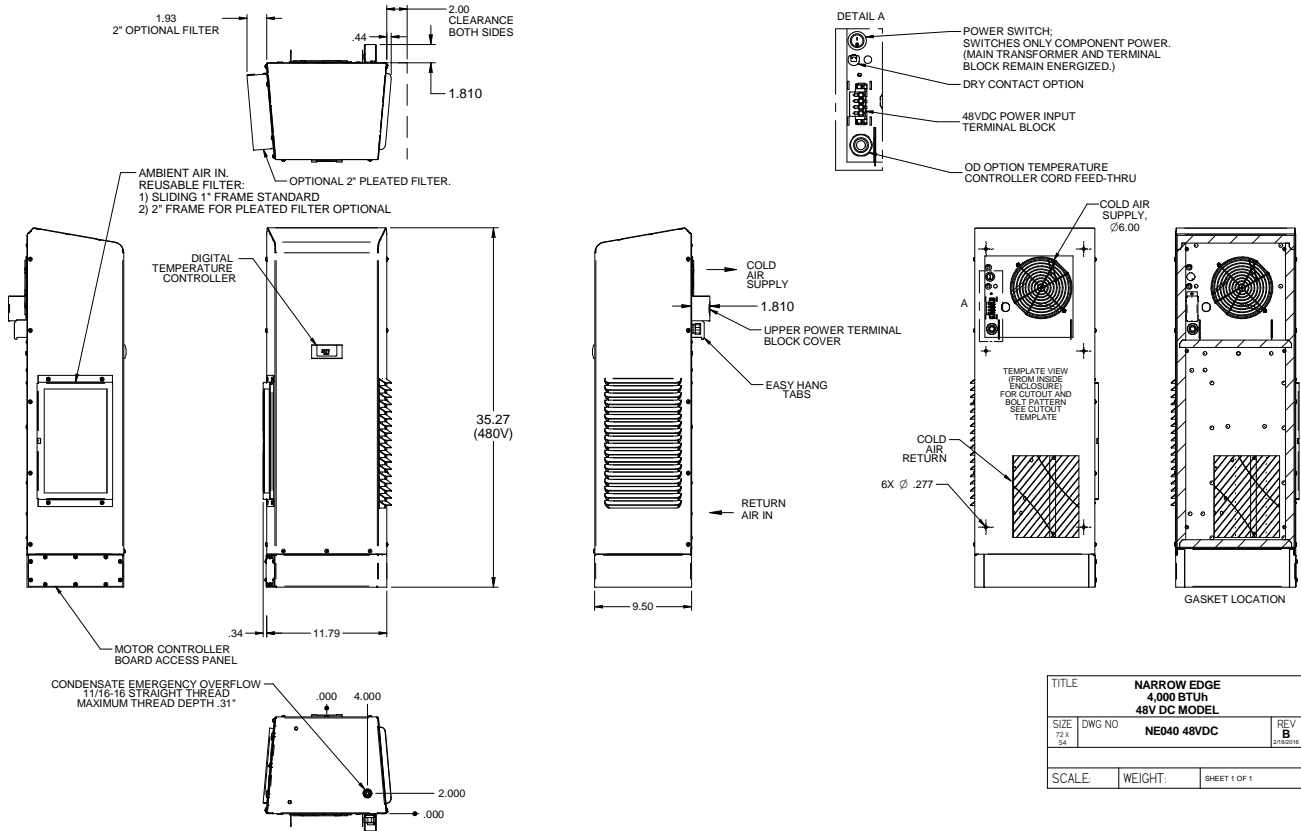
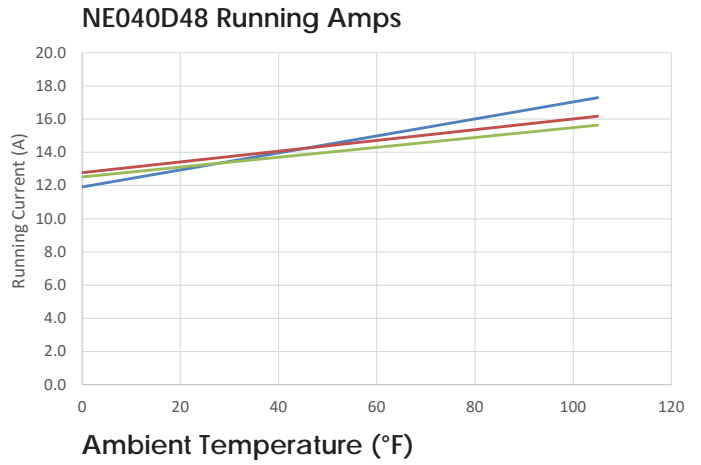
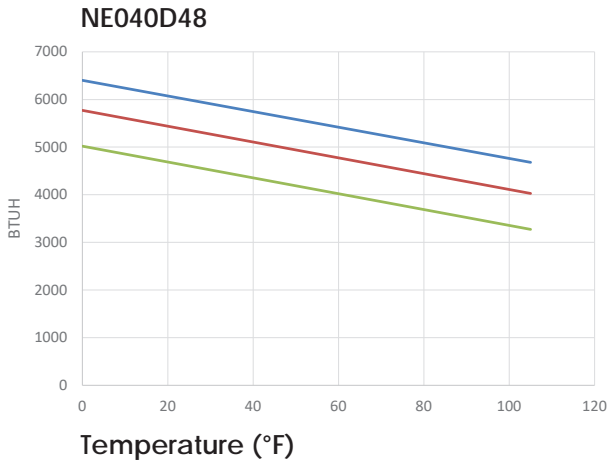

TITLE			NARROW EDGE		
			4,000 BTUH		
			48V DC MODEL		
SIZE	DWG NO	REV		B	
72 X 54	NE040 48VDC	01		02/2016	
SCALE	WEIGHT	SHEET 1 OF 1			



ATTENTION: If ordering a replacement for a Thermal Edge air conditioner, please include the part number and serial number of the unit being replaced in your order. This will ensure that we ship a replacement that is compatible with the cutout dimensions and power connection features of the older model. All information subject to change without notice.

4000 BTUH | INDOOR/OUTDOOR, UL TYPES 12, 4 & 4X AVAILABLE

Engineered & manufactured to endure the most difficult of environments and applications.

Thermal Edge air conditioners will exceed environmental requirements in applications like Steel, Food Processing, Petro-Chemical, Cement, Paper & Pulp and Plastics.



Digital Temperature Controller

- Programmable set point and temperature controls
- Visible Error and/or alarm messaging
- System status indication & keypad lockout function

Active Condensate Evaporation System

- Constant elimination of condensate
- Increases unit efficiency by pre-cooling refrigerant

Key Design Features

- Sloped top to allow for water runoff
- Designed with rigid chassis and seam welded shroud
- Thoughtful interior design for easy maintenance
- Narrow body style fits on 12" enclosure

Unit Efficiency

- Temperature operated condenser fan reduces power inrush and saves energy
- Highly efficient rotary compressor
- Fully insulated & sealed cabinet
- Thermal Expansion Valve to maintain cooling capacity over a broad ambient temperature range

Compressor Protection System

- High & Low refrigerant cutouts with fault indication
- Compressor anti short cycle protection
- Thermal overload protector
- Compressor run capacitors reduce power inrush, save energy and increase compressor life

OPTIONS:

- Low/High Ambient
- Remote Controller
- Corrosion Protection
- Redundant System
- Remote Control/Monitor
- Controller Programming
- Open Door Kill Switch
- Extended Temp. Probe
- Heater
- Dry Contact
- Hazardous Location
- Custom Finish
- Filter/Filter Frame
- Vibration Resistant

Model	UL Type	BTU/Hour	Material	Voltage/Phase/Hz.	Running Amps	Max. Amb. Temp.	H x W x D	Unit Weight (lbs.)
NE04012612	12	4000	Powder coated steel	115/1/60	6.76	125°F (131°F*)	32" x 11.8" x 9.5"	70
NE04012604	4	4000	Powder coated steel	115/1/60	6.76	125°F (131°F*)	32" x 11.8" x 9.5"	70
NE0401264X	4X	4000	Stainless steel	115/1/60	6.76	125°F (131°F*)	32" x 11.8" x 9.5"	70
NE0401264XL4	4X	4000	Mill finish aluminum	115/1/60	6.76	125°F (131°F*)	32" x 11.8" x 9.5"	60
NE04023612	12	4000	Powder coated steel	230/1/60	3.07	125°F	32" x 11.8" x 9.5"	72
NE04023604	4	4000	Powder coated steel	230/1/60	3.07	125°F	32" x 11.8" x 9.5"	72
NE0402364X	4X	4000	Stainless steel	230/1/60	3.07	125°F	32" x 11.8" x 9.5"	72
NE0402364XL4	4X	4000	Mill finish aluminum	230/1/60	3.07	125°F	32" x 11.8" x 9.5"	62
NE04048612	12	4000	Powder coated steel	460/1/60	1.69	125°F (131°F*)	38" x 11.8" x 9.5"	103
NE04048604	4	4000	Powder coated steel	460/1/60	1.69	125°F (131°F*)	38" x 11.8" x 9.5"	103
NE0404864X	4X	4000	Stainless steel	460/1/60	1.69	125°F (131°F*)	38" x 11.8" x 9.5"	103
NE0404864XL5	4X	4000	Mill finish aluminum	460/1/60	1.69	125°F (131°F*)	38" x 11.8" x 9.5"	93

* Must be ordered with the high ambient A3 option

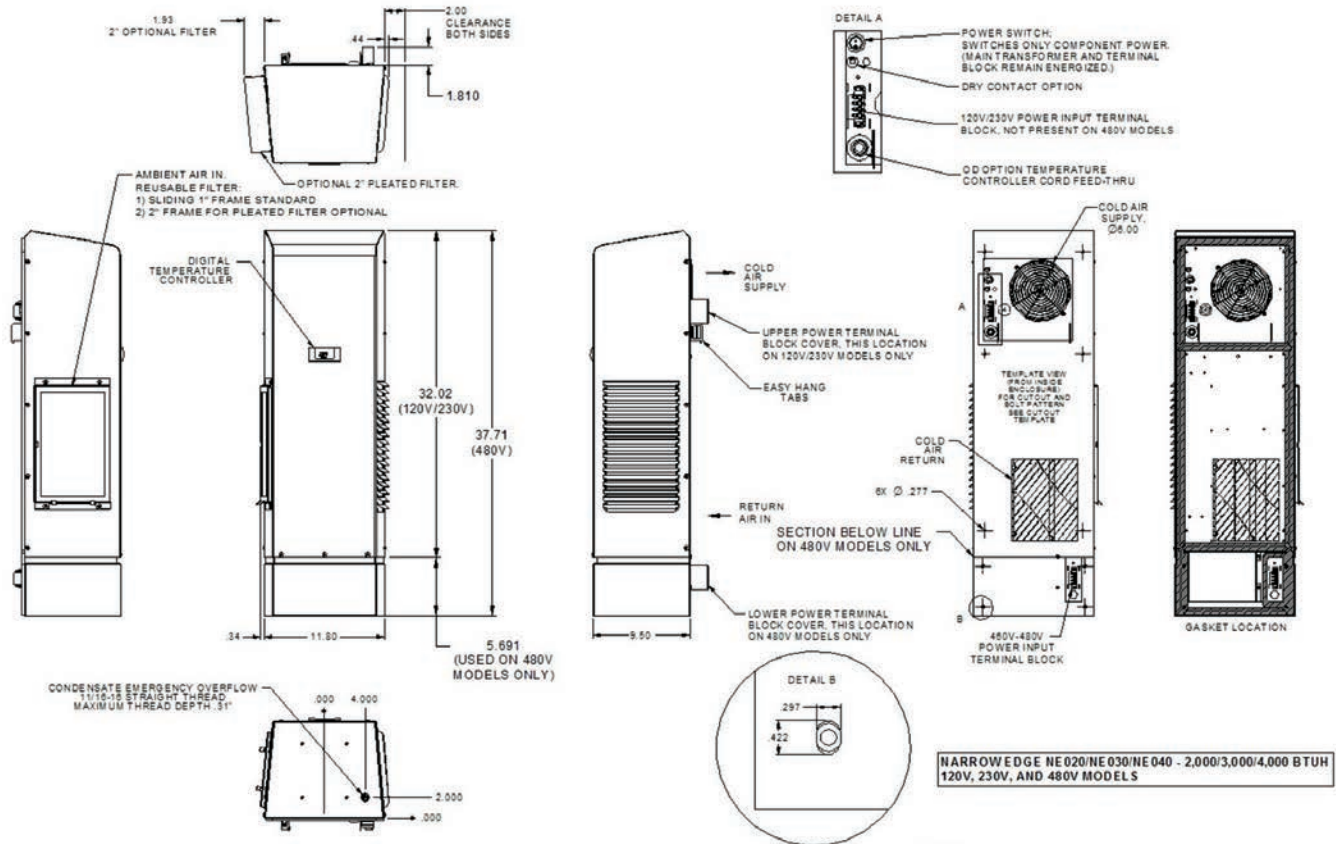
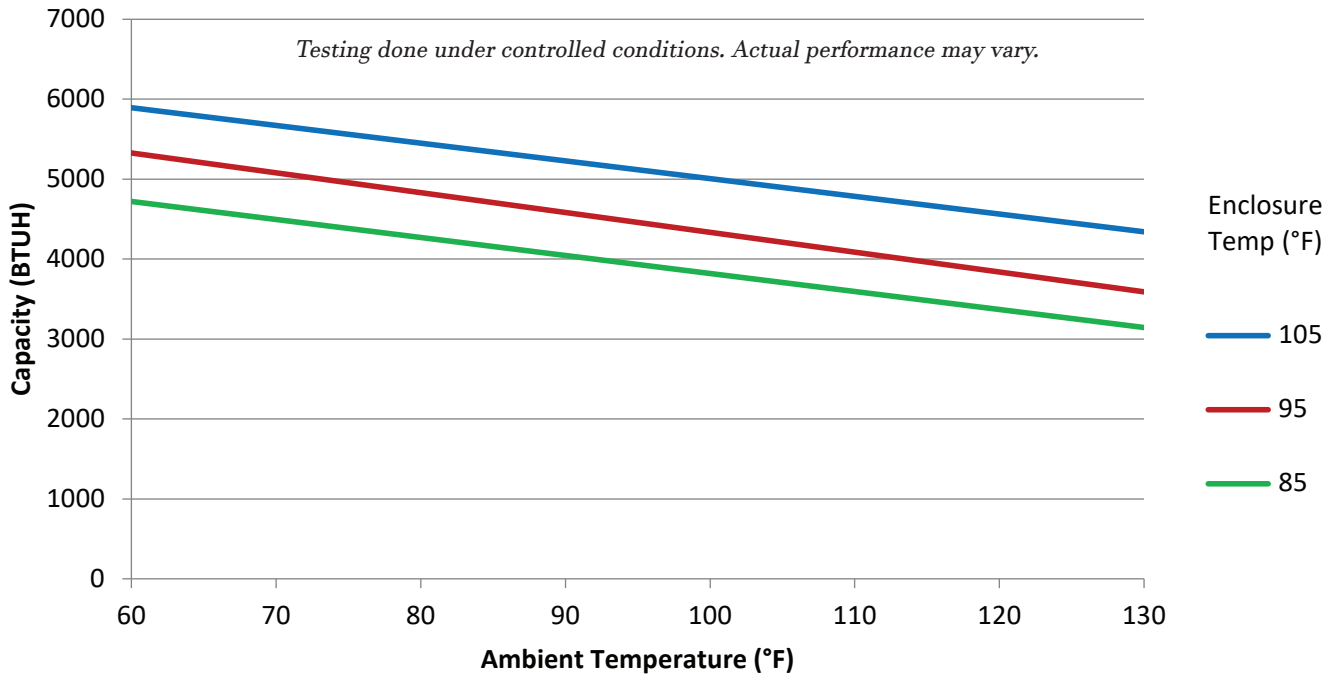

ATTENTION: If ordering a replacement for a Thermal Edge air conditioner, please include the part number and serial number of the unit being replaced in your order. This will ensure that we ship a replacement that is compatible with the cutout dimensions and power connection features of the older model. All information subject to change without notice.

4000 BTUH

INDOOR/OUTDOOR, UL TYPES 12, 4 & 4X AVAILABLE

Engineered & manufactured to endure the most difficult of environments and applications. Thermal Edge air conditioners will exceed environmental requirements in applications like Steel, Food Processing, Petro-Chemical, Cement, Paper & Pulp and Plastics.



Digital Temperature Controller

- Programmable set point and temperature controls
- Visible Error and/or alarm messaging
- System status indication & keypad lockout function

Active Condensate Evaporation System

- Constant elimination of condensate
- Increases unit efficiency by pre-cooling refrigerant

Key Design Features

- Sloped top to allow for water runoff
- Designed with rigid chassis and seam welded shroud
- Thoughtful interior design for easy maintenance
- Narrow body style fits on 12" enclosure

Unit Efficiency

- Temperature operated condenser fan reduces power inrush and saves energy
- Highly efficient rotary compressor
- Fully insulated & sealed cabinet
- Thermal Expansion Valve to maintain cooling capacity over a broad ambient temperature range

Compressor Protection System

- High & Low refrigerant cutouts with fault indication
- Compressor anti short cycle protection
- Thermal overload protector
- Compressor run capacitors reduce power inrush, save energy and increase compressor life

OPTIONS:

- Low/High Ambient
- Remote Controller
- Corrosion Protection
- Redundant System
- Remote Control/Monitor
- Controller Programming
- Open Door Kill Switch
- Extended Temp. Probe
- Heater
- Dry Contact
- Hazardous Location
- Filter/Filter Frame
- Custom Finish
- Vibration Resistant

Model	UL Type	BTU/Hour	Material	Voltage/Phase/Hz.	Running Amps	Max. Amb. Temp.	H x W x D	Unit Weight (lbs.)
NE04S48612	12	4000	Powder coated steel	460/1/60	1.69	125°F	32.02" x 11.83" x 15.06"	103
NE04S48604	4	4000	Powder coated steel	460/1/60	1.69	125°F	32.02" x 11.83" x 15.06"	103
NE04S4864X	4X	4000	Stainless steel	460/1/60	1.69	125°F	32.02" x 11.83" x 15.06"	103
NE04S4864XL5	4X	4000	Mill finish aluminum	460/1/60	1.69	125°F	32.02" x 11.83" x 15.06"	93

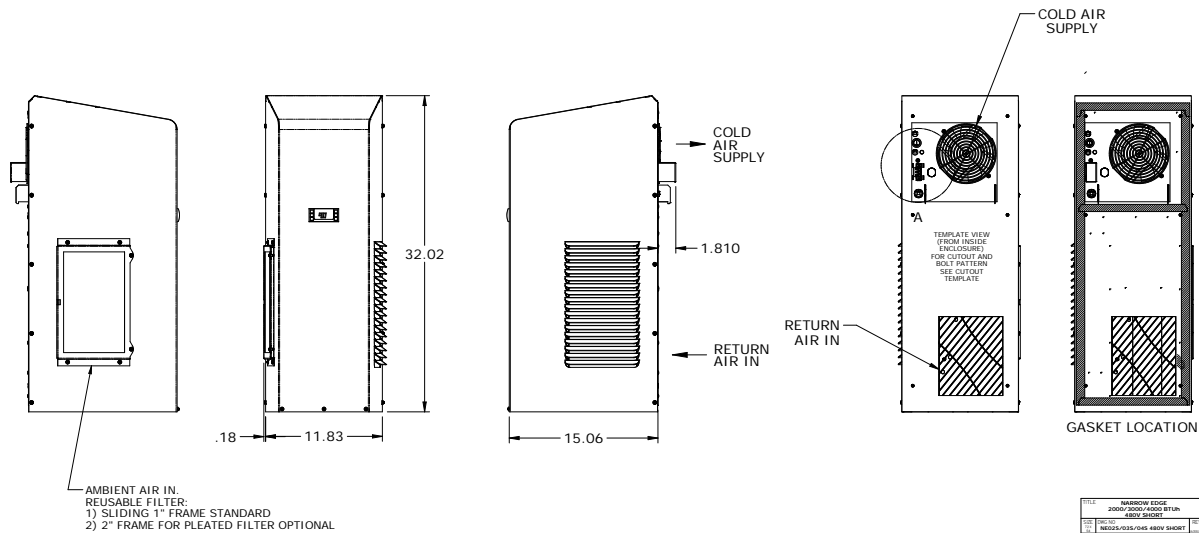
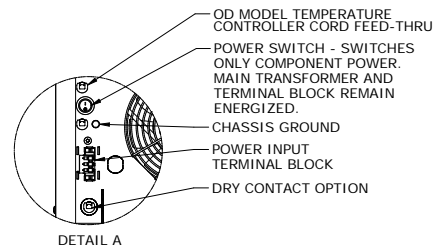
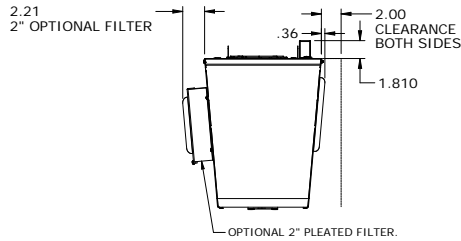
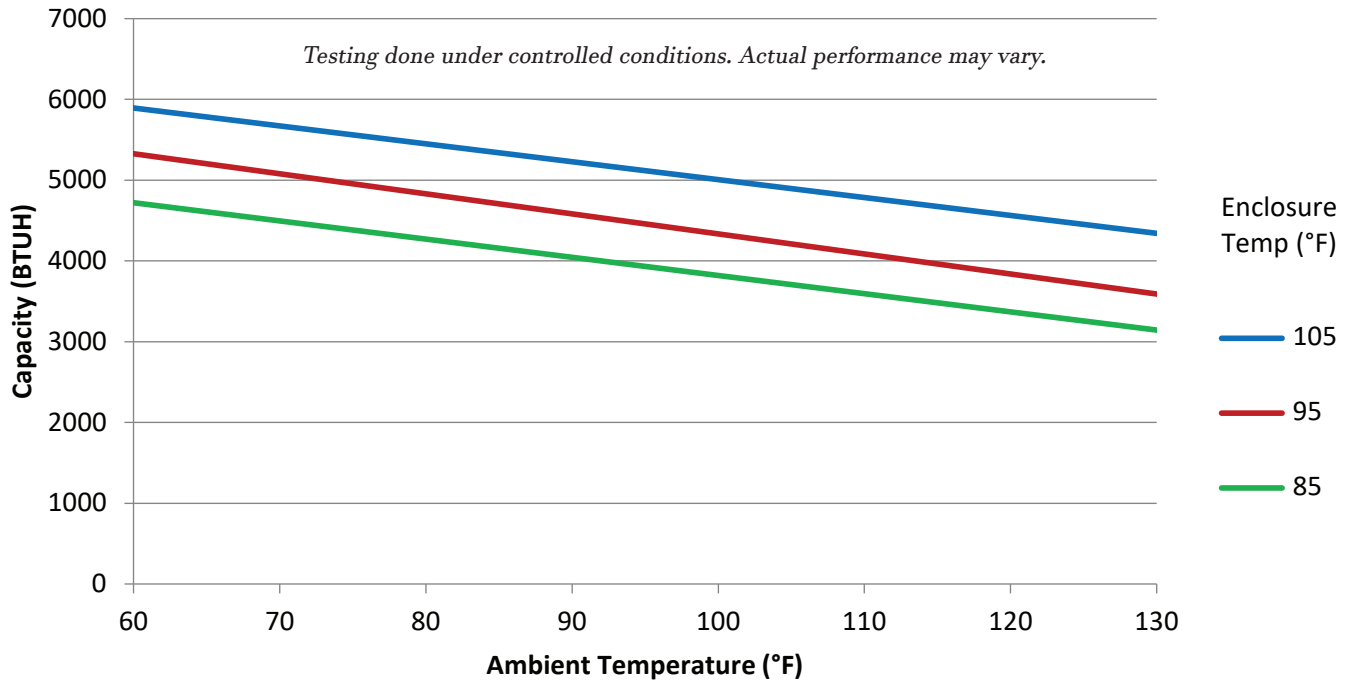

REV	DESCRIPTION
001	MINOR EDGE 2000/3000/4000 BTUH 400V SHED
002	2000/3000/4000 BTUH 400V SHED
003	2000/3000/4000 BTUH 400V SHED
004	2000/3000/4000 BTUH 400V SHED
005	2000/3000/4000 BTUH 400V SHED
006	2000/3000/4000 BTUH 400V SHED
007	2000/3000/4000 BTUH 400V SHED
008	2000/3000/4000 BTUH 400V SHED
009	2000/3000/4000 BTUH 400V SHED
010	2000/3000/4000 BTUH 400V SHED
011	2000/3000/4000 BTUH 400V SHED
012	2000/3000/4000 BTUH 400V SHED
013	2000/3000/4000 BTUH 400V SHED
014	2000/3000/4000 BTUH 400V SHED
015	2000/3000/4000 BTUH 400V SHED
016	2000/3000/4000 BTUH 400V SHED
017	2000/3000/4000 BTUH 400V SHED
018	2000/3000/4000 BTUH 400V SHED
019	2000/3000/4000 BTUH 400V SHED
020	2000/3000/4000 BTUH 400V SHED
021	2000/3000/4000 BTUH 400V SHED
022	2000/3000/4000 BTUH 400V SHED
023	2000/3000/4000 BTUH 400V SHED
024	2000/3000/4000 BTUH 400V SHED
025	2000/3000/4000 BTUH 400V SHED
026	2000/3000/4000 BTUH 400V SHED
027	2000/3000/4000 BTUH 400V SHED
028	2000/3000/4000 BTUH 400V SHED
029	2000/3000/4000 BTUH 400V SHED
030	2000/3000/4000 BTUH 400V SHED
031	2000/3000/4000 BTUH 400V SHED
032	2000/3000/4000 BTUH 400V SHED
033	2000/3000/4000 BTUH 400V SHED
034	2000/3000/4000 BTUH 400V SHED
035	2000/3000/4000 BTUH 400V SHED
036	2000/3000/4000 BTUH 400V SHED
037	2000/3000/4000 BTUH 400V SHED
038	2000/3000/4000 BTUH 400V SHED
039	2000/3000/4000 BTUH 400V SHED
040	2000/3000/4000 BTUH 400V SHED
041	2000/3000/4000 BTUH 400V SHED
042	2000/3000/4000 BTUH 400V SHED
043	2000/3000/4000 BTUH 400V SHED
044	2000/3000/4000 BTUH 400V SHED
045	2000/3000/4000 BTUH 400V SHED
046	2000/3000/4000 BTUH 400V SHED
047	2000/3000/4000 BTUH 400V SHED
048	2000/3000/4000 BTUH 400V SHED
049	2000/3000/4000 BTUH 400V SHED
050	2000/3000/4000 BTUH 400V SHED
051	2000/3000/4000 BTUH 400V SHED
052	2000/3000/4000 BTUH 400V SHED
053	2000/3000/4000 BTUH 400V SHED
054	2000/3000/4000 BTUH 400V SHED
055	2000/3000/4000 BTUH 400V SHED
056	2000/3000/4000 BTUH 400V SHED
057	2000/3000/4000 BTUH 400V SHED
058	2000/3000/4000 BTUH 400V SHED
059	2000/3000/4000 BTUH 400V SHED
060	2000/3000/4000 BTUH 400V SHED
061	2000/3000/4000 BTUH 400V SHED
062	2000/3000/4000 BTUH 400V SHED
063	2000/3000/4000 BTUH 400V SHED
064	2000/3000/4000 BTUH 400V SHED
065	2000/3000/4000 BTUH 400V SHED
066	2000/3000/4000 BTUH 400V SHED
067	2000/3000/4000 BTUH 400V SHED
068	2000/3000/4000 BTUH 400V SHED
069	2000/3000/4000 BTUH 400V SHED
070	2000/3000/4000 BTUH 400V SHED
071	2000/3000/4000 BTUH 400V SHED
072	2000/3000/4000 BTUH 400V SHED
073	2000/3000/4000 BTUH 400V SHED
074	2000/3000/4000 BTUH 400V SHED
075	2000/3000/4000 BTUH 400V SHED
076	2000/3000/4000 BTUH 400V SHED
077	2000/3000/4000 BTUH 400V SHED
078	2000/3000/4000 BTUH 400V SHED
079	2000/3000/4000 BTUH 400V SHED
080	2000/3000/4000 BTUH 400V SHED
081	2000/3000/4000 BTUH 400V SHED
082	2000/3000/4000 BTUH 400V SHED
083	2000/3000/4000 BTUH 400V SHED
084	2000/3000/4000 BTUH 400V SHED
085	2000/3000/4000 BTUH 400V SHED
086	2000/3000/4000 BTUH 400V SHED
087	2000/3000/4000 BTUH 400V SHED
088	2000/3000/4000 BTUH 400V SHED
089	2000/3000/4000 BTUH 400V SHED
090	2000/3000/4000 BTUH 400V SHED
091	2000/3000/4000 BTUH 400V SHED
092	2000/3000/4000 BTUH 400V SHED
093	2000/3000/4000 BTUH 400V SHED
094	2000/3000/4000 BTUH 400V SHED
095	2000/3000/4000 BTUH 400V SHED
096	2000/3000/4000 BTUH 400V SHED
097	2000/3000/4000 BTUH 400V SHED
098	2000/3000/4000 BTUH 400V SHED
099	2000/3000/4000 BTUH 400V SHED
100	2000/3000/4000 BTUH 400V SHED



ATTENTION: If ordering a replacement for a Thermal Edge air conditioner, please include the part number and serial number of the unit being replaced in your order. This will ensure that we ship a replacement that is compatible with the cutout dimensions and power connection features of the older model. All information subject to change without notice.

5000 BTUH | INDOOR/OUTDOOR, UL TYPES 12, 4 & 4X AVAILABLE

Engineered & manufactured to endure the most difficult of environments and applications.

Thermal Edge air conditioners will exceed environmental requirements in applications like Steel, Food Processing, Petro-Chemical, Cement, Paper & Pulp and Plastics.



Digital Temperature Controller

- Programmable set point and temperature controls
- Visible Error and/or alarm messaging
- System status indication & keypad lockout function

Active Condensate Evaporation System

- Constant elimination of condensate
- Increases unit efficiency by pre-cooling refrigerant

Key Design Features

- Sloped top to allow for water runoff
- Designed with rigid chassis and seam welded shroud
- Thoughtful interior design for easy maintenance
- Narrow body style fits on 12" enclosure

Unit Efficiency

- Temperature operated condenser fan reduces power inrush and saves energy
- Highly efficient rotary compressor
- Fully insulated & sealed cabinet
- Thermal Expansion Valve to maintain cooling capacity over a broad ambient temperature range

Compressor Protection System

- High & Low refrigerant cutouts with fault indication
- Compressor anti short cycle protection
- Thermal overload protector
- Compressor run capacitors reduce power inrush, save energy and increase compressor life

OPTIONS:

- Low/High Ambient
- Remote Controller
- Corrosion Protection
- Redundant System
- Remote Control/Monitor
- Controller Programming
- Open Door Kill Switch
- Extended Temp. Probe
- Heater
- Dry Contact
- Filter/Filter Frame
- Hazardous Location
- Custom Finish
- Vibration Resistant
- Diagnostics

Model	UL Type	BTU/Hour	Material	Voltage/Phase/Hz.	Running Amps	Max. Amb. Temp.	H x W x D	Unit Weight (lbs.)
NE05012612	12	5000	Powder coated steel	115/1/60	6.14	140°F	36" x 11.8" x 15.02"	97
NE05012604	4	5000	Powder coated steel	115/1/60	6.14	140°F	36" x 11.8" x 15.02"	97
NE0501264X	4X	5000	Stainless steel	115/1/60	6.14	140°F	36" x 11.8" x 15.02"	97
NE0501264XL4	4X	5000	Mill finish aluminum	115/1/60	6.14	140°F	36" x 11.8" x 15.02"	87
NE05023612	12	5000	Powder coated steel	230/1/60	3.76	140°F	36" x 11.8" x 15.02"	92
NE05023604	4	5000	Powder coated steel	230/1/60	3.76	140°F	36" x 11.8" x 15.02"	92
NE0502364X	4X	5000	Stainless steel	230/1/60	3.76	140°F	36" x 11.8" x 15.02"	92
NE0502364XL4	4X	5000	Mill finish aluminum	230/1/60	3.76	140°F	36" x 11.8" x 15.02"	82
NE05048612	12	5000	Powder coated steel	460/1/60	1.9	140°F	44.63" x 11.8" x 15.02"	136
NE05048604	4	5000	Powder coated steel	460/1/60	1.9	140°F	44.63" x 11.8" x 15.02"	136
NE0504864X	4X	5000	Stainless steel	460/1/60	1.9	140°F	44.63" x 11.8" x 15.02"	136
NE0504864XL5	4X	5000	Mill finish aluminum	460/1/60	1.9	140°F	44.63" x 11.8" x 15.02"	126

Testing done under controlled conditions. Actual performance may vary.

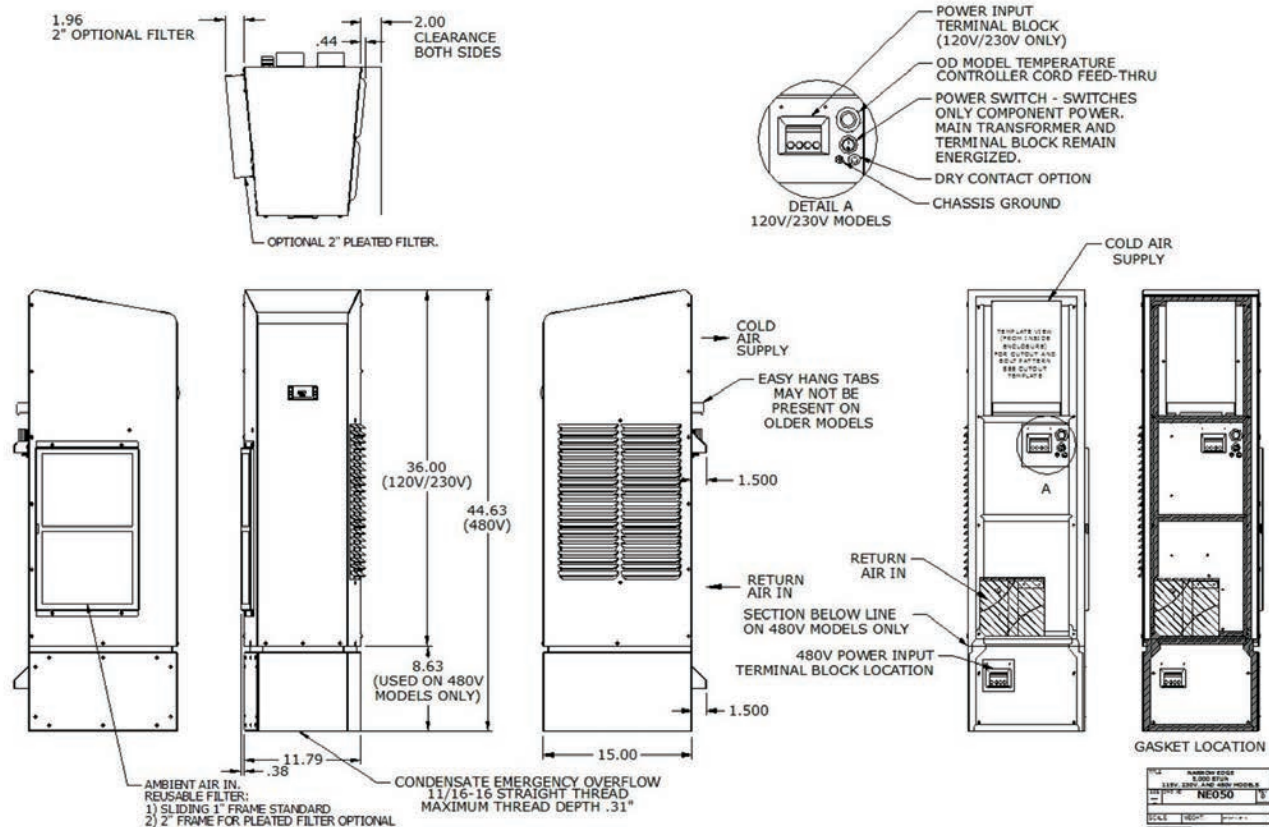
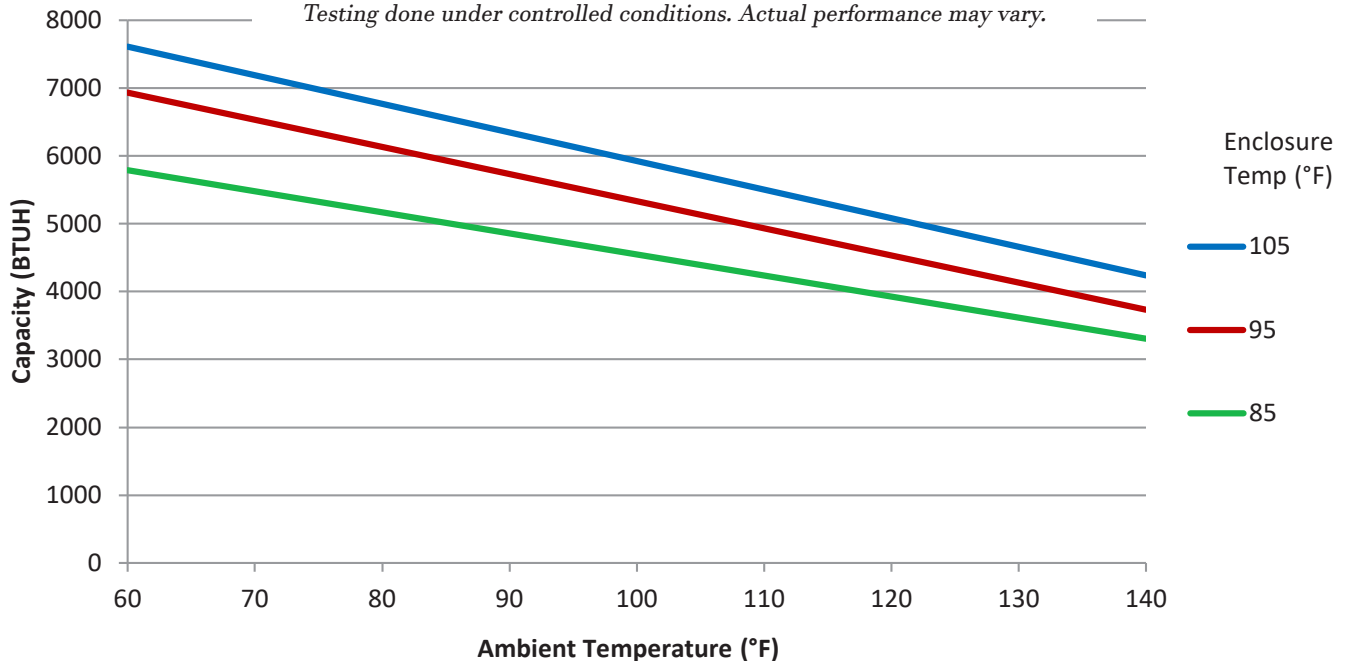

ATTENTION: If ordering a replacement for a Thermal Edge air conditioner, please include the part number and serial number of the unit being replaced in your order. This will ensure that we ship a replacement that is compatible with the cutout dimensions and power connection features of the older model. All information subject to change without notice.



6000 BTUH | INDOOR/OUTDOOR, UL TYPES 12, 4 & 4X AVAILABLE

Engineered & manufactured to endure the most difficult of environments and applications.

Thermal Edge air conditioners will exceed environmental requirements in applications like Steel, Food Processing, Petro-Chemical, Cement, Paper & Pulp and Plastics.



Digital Temperature Controller

- Programmable set point and temperature controls
- Visible Error and/or alarm messaging
- System status indication & keypad lockout function

Active Condensate Evaporation System

- Constant elimination of condensate
- Increases unit efficiency by pre-cooling refrigerant

Key Design Features

- Sloped top to allow for water runoff
- Designed with rigid chassis and seam welded shroud
- Thoughtful interior design for easy maintenance
- Narrow body style fits on 12" enclosure

Unit Efficiency

- Temperature operated condenser fan reduces power inrush and saves energy
- Highly efficient rotary compressor
- Fully insulated & sealed cabinet
- Thermal Expansion Valve to maintain cooling capacity over a broad ambient temperature range

Compressor Protection System

- High & Low refrigerant cutouts with fault indication
- Compressor anti short cycle protection
- Thermal overload protector
- Compressor run capacitors reduce power inrush, save energy and increase compressor life

OPTIONS:

- Low/High Ambient
- Remote Controller
- Corrosion Protection
- Redundant System
- Remote Control/Monitor
- Controller Programming
- Open Door Kill Switch
- Extended Temp. Probe
- Heater
- Dry Contact
- Filter/Filter Frame
- Hazardous Location
- Custom Finish
- Vibration Resistant
- Diagnostics

Model	UL Type	BTU/Hour	Material	Voltage/Phase/Hz.	Running Amps	Max. Amb. Temp.	H x W x D	Unit Weight (lbs.)
NE06012612	12	6000	Powder coated steel	115/1/60	7.83	125°F	36" x 11.8" x 15.02"	97
NE06012604	4	6000	Powder coated steel	115/1/60	7.83	125°F	36" x 11.8" x 15.02"	97
NE0601264X	4X	6000	Stainless steel	115/1/60	7.83	125°F	36" x 11.8" x 15.02"	97
NE0601264XL4	4X	6000	Mill finish aluminum	115/1/60	7.83	125°F	36" x 11.8" x 15.02"	87
NE06023612	12	6000	Powder coated steel	230/1/60	4.8	125°F	36" x 11.8" x 15.02"	98
NE06023604	4	6000	Powder coated steel	230/1/60	4.8	125°F	36" x 11.8" x 15.02"	98
NE0602364X	4X	6000	Stainless steel	230/1/60	4.8	125°F	36" x 11.8" x 15.02"	98
NE0602364XL4	4X	6000	Mill finish aluminum	230/1/60	4.8	125°F	36" x 11.8" x 15.02"	88
NE06048612	12	6000	Powder coated steel	460/1/60	2.4	125°F	44.63" x 11.8" x 15.02"	142
NE06048604	4	6000	Powder coated steel	460/1/60	2.4	125°F	44.63" x 11.8" x 15.02"	142
NE0604864X	4X	6000	Stainless steel	460/1/60	2.4	125°F	44.63" x 11.8" x 15.02"	142
NE0604864XL5	4X	6000	Mill finish aluminum	460/1/60	2.4	125°F	44.63" x 11.8" x 15.02"	132

Testing done under controlled conditions. Actual performance may vary.

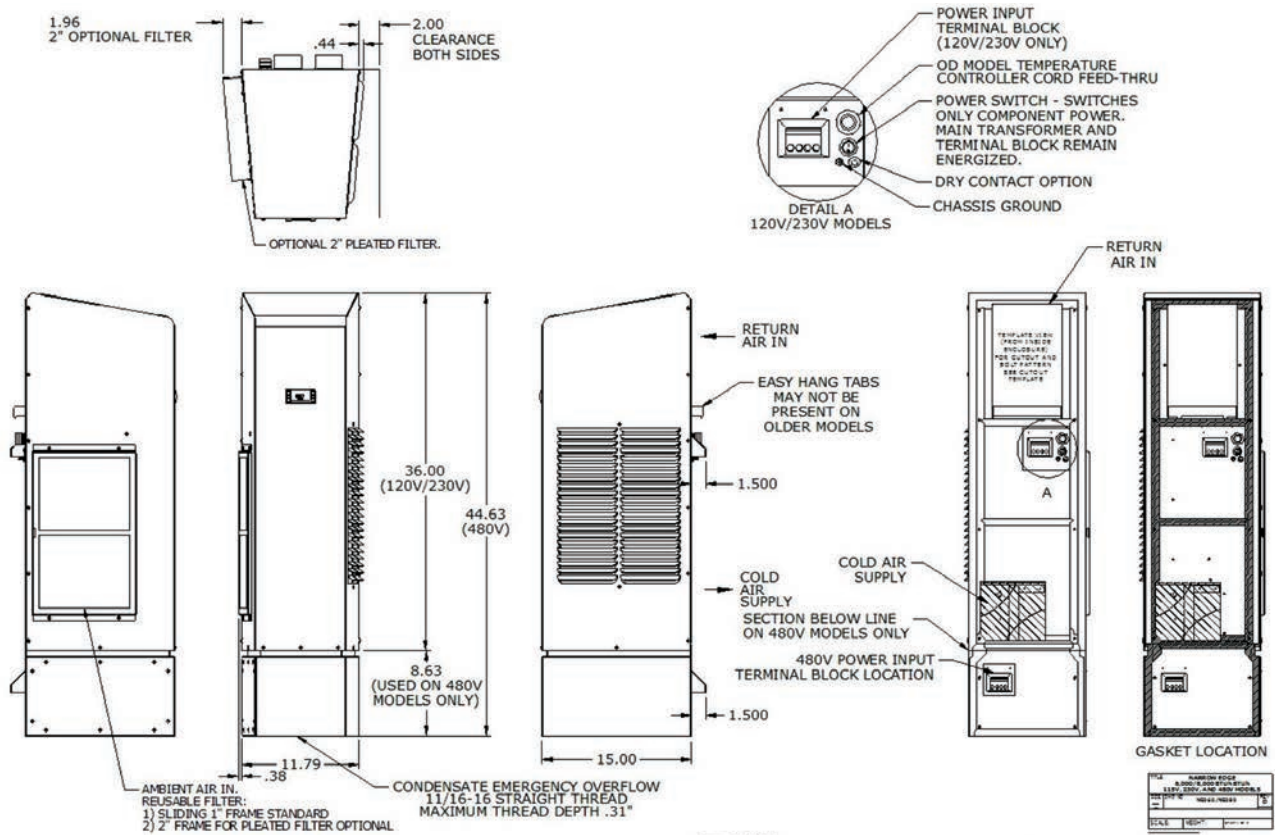
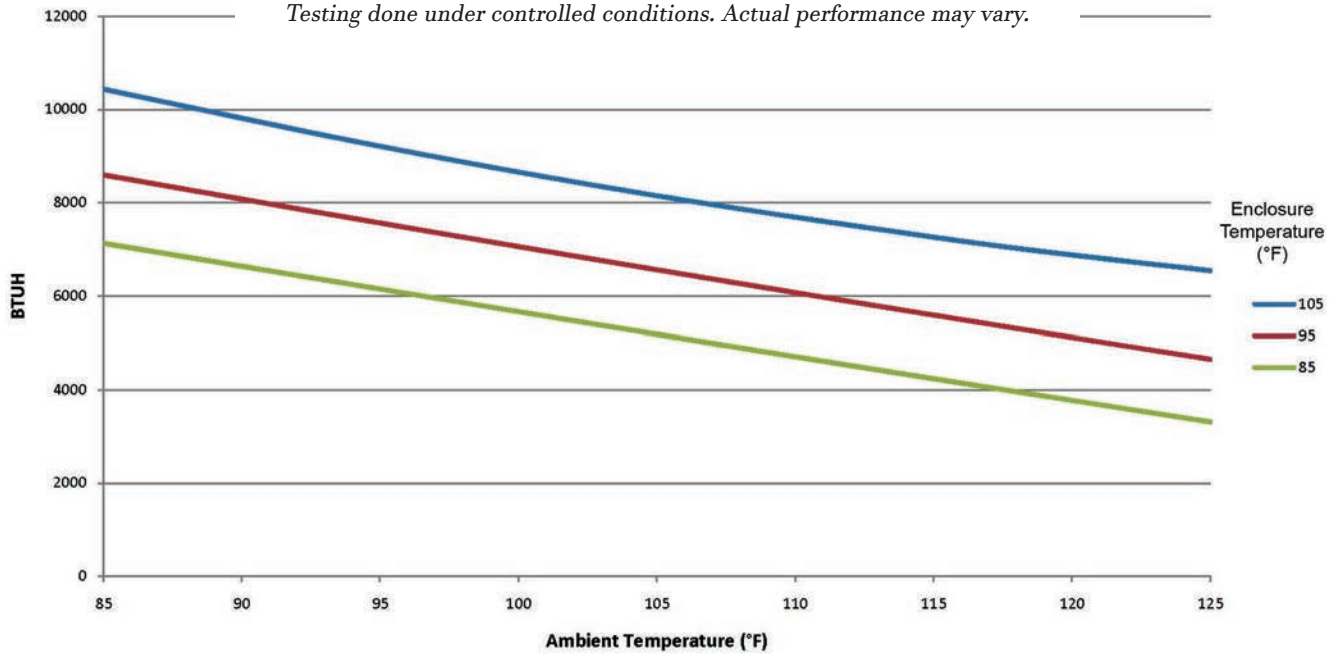

ATTENTION: If ordering a replacement for a Thermal Edge air conditioner, please include the part number and serial number of the unit being replaced in your order. This will ensure that we ship a replacement that is compatible with the cutout dimensions and power connection features of the older model. All information subject to change without notice.



6000 BTUH TOP MOUNT | INDOOR/OUTDOOR, UL TYPES 12, 4 & 4X AVAILABLE

Engineered & manufactured to endure the most difficult of environments and applications.

Thermal Edge air conditioners will exceed environmental requirements in applications like Steel, Food Processing, Petro-Chemical, Cement, Paper & Pulp and Plastics.



Digital Temperature Controller

- Programmable set point and temperature controls
- Visible Error and/or alarm messaging
- System status indication & keypad lockout function

Active Condensate Evaporation System

- Constant elimination of condensate
- Increases unit efficiency by pre-cooling refrigerant

Key Design Features

- Designed with rigid chassis and seam welded shroud
- Thoughtful interior design for easy maintenance
- Integrated lifting eyes

Unit Efficiency

- Highly efficient rotary compressor
- Fully insulated & sealed cabinet
- Thermal Expansion Valve to maintain cooling capacity over a broad ambient temperature range

Compressor Protection System

- High & Low refrigerant cutouts with fault indication
- Compressor anti short cycle protection
- Thermal overload protector
- Compressor run capacitors reduce power inrush, save energy and increase compressor life

Filter Free Operation

OPTIONS:

- Low/High Ambient
- Remote Controller
- Corrosion Protection
- Redundant System
- Remote Control/Monitor
- Controller Programming
- Open Door Kill Switch
- Extended Temp. Probe
- Heater
- Dry Contact
- Filter/Filter Frame
- Hazardous Location
- Custom Finish
- Diagnostics

Model	UL Type	BTU/Hour	Material	Voltage/Phase/Hz.	Running Amps	Max. Amb. Temp.	H x W x D	Unit Weight (lbs.)
TM06112612	12	6000	Powder coated steel	115/1/60	10.6	131°F	15.6" x 26.3" x 20.2"	111
TM06112604	4	6000	Powder coated steel	115/1/60	10.6	131°F	15.6" x 30.6" x 20.2"	111
TM0611264X	4X	6000	Stainless steel	115/1/60	10.6	131°F	15.6" x 30.6" x 20.2"	111
TM0611264XL4	4X	6000	Mill finish aluminum	115/1/60	10.6	131°F	15.6" x 30.6" x 20.2"	101
TM06123612	12	6000	Powder coated steel	230/1/60	6.0	131°F	15.6" x 26.3" x 20.2"	111
TM06123604	4	6000	Powder coated steel	230/1/60	6.0	131°F	15.6" x 30.6" x 20.2"	111
TM0612364X	4X	6000	Stainless steel	230/1/60	6.0	131°F	15.6" x 30.6" x 20.2"	111
TM0612364XL4	4X	6000	Mill finish aluminum	230/1/60	6.0	131°F	15.6" x 30.6" x 20.2"	101
TM06148612	12	6000	Powder coated steel	460/1/60	2.9	131°F	15.6" x 26.3" x 20.2"	154
TM06148604	4	6000	Powder coated steel	460/1/60	2.9	131°F	15.6" x 30.6" x 20.2"	154
TM0614864X	4X	6000	Stainless steel	460/1/60	2.9	131°F	15.6" x 30.6" x 20.2"	154
TM0614864XL4	4X	6000	Mill finish aluminum	460/1/60	2.9	131°F	15.6" x 30.6" x 20.2"	144

Testing done under controlled conditions. Actual performance may vary.

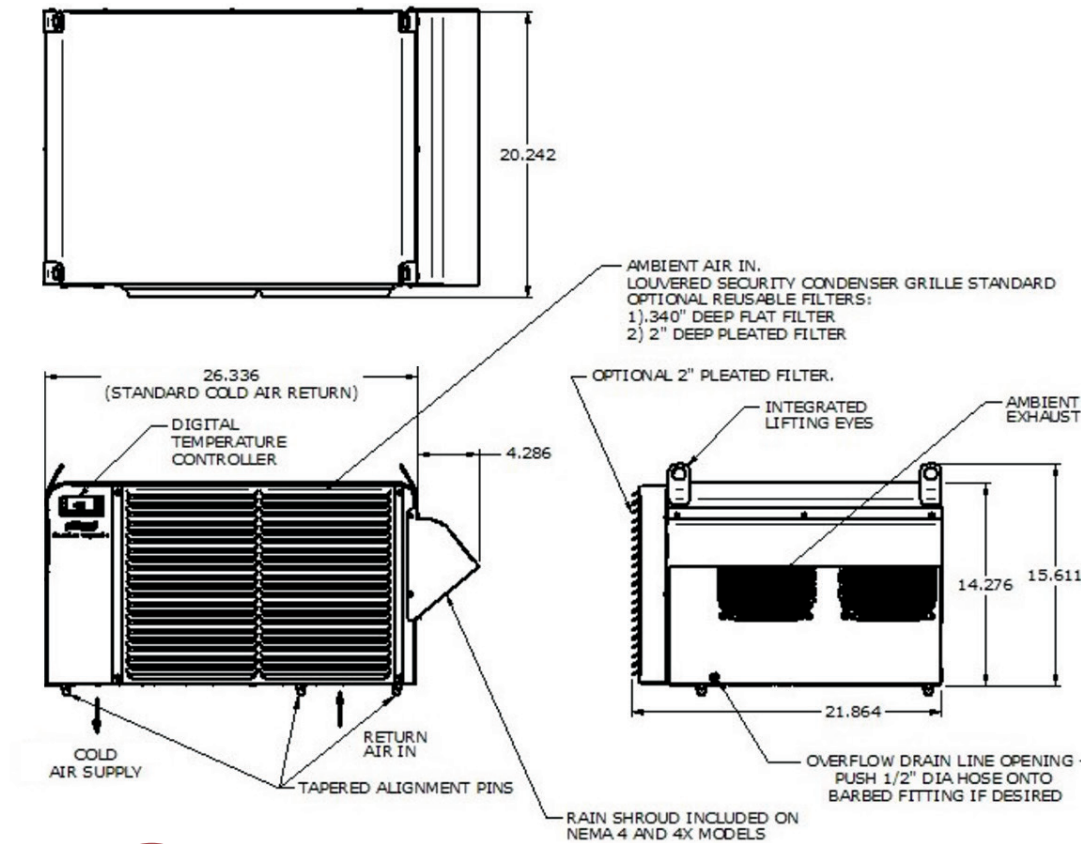
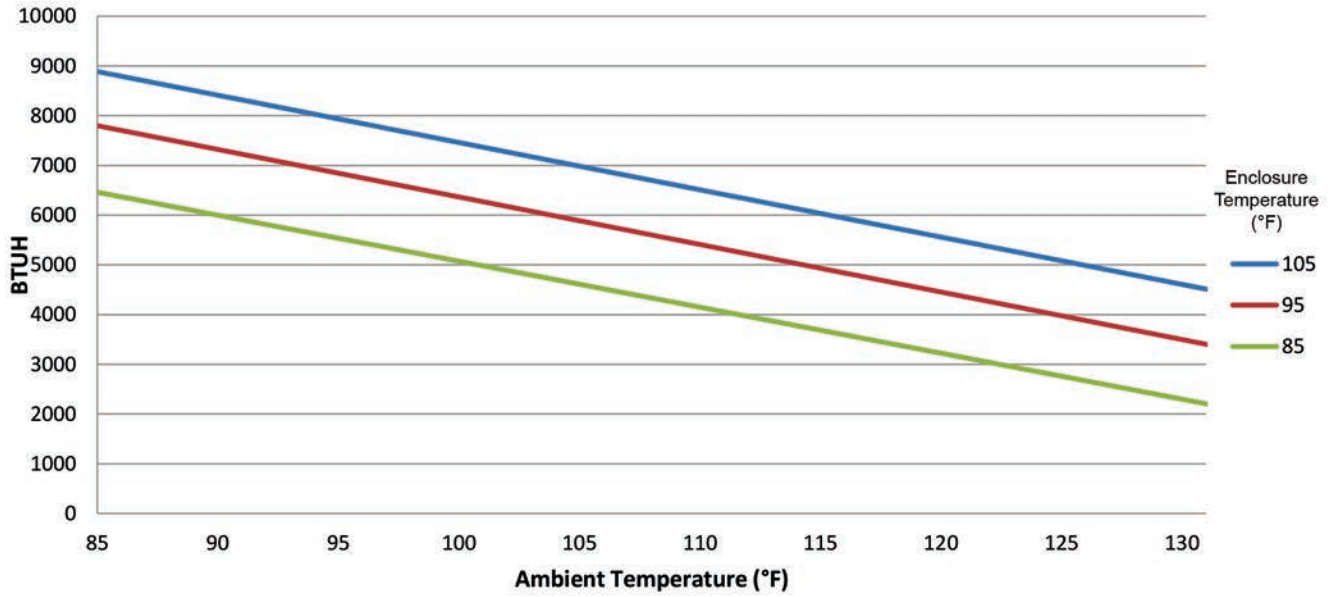

ATTENTION: If ordering a replacement for a Thermal Edge air conditioner, please include the part number and serial number of the unit being replaced in your order. This will ensure that we ship a replacement that is compatible with the cutout dimensions and power connection features of the older model. All information subject to change without notice.

8000 BTUH | INDOOR/OUTDOOR, UL TYPES 12, 4 & 4X AVAILABLE

Engineered & manufactured to endure the most difficult of environments and applications.

Thermal Edge air conditioners will exceed environmental requirements in applications like Steel, Food Processing, Petro-Chemical, Cement, Paper & Pulp and Plastics.



Digital Temperature Controller

- Programmable set point and temperature controls
- Visible Error and/or alarm messaging
- System status indication & keypad lockout function

Active Condensate Evaporation System

- Constant elimination of condensate
- Increases unit efficiency by pre-cooling refrigerant

Key Design Features

- Sloped top to allow for water runoff
- Designed with rigid chassis and seam welded shroud
- Thoughtful interior design for easy maintenance
- Narrow body style fits on 12" enclosure

Unit Efficiency

- Temperature operated condenser fan reduces power inrush and saves energy
- Highly efficient rotary compressor
- Fully insulated & sealed cabinet
- Thermal Expansion Valve to maintain cooling capacity over a broad ambient temperature range

Compressor Protection System

- High & Low refrigerant cutouts with fault indication
- Compressor anti short cycle protection
- Thermal overload protector
- Compressor run capacitors reduce power inrush, save energy and increase compressor life

OPTIONS:

- Low/High Ambient
- Remote Controller
- Corrosion Protection
- Redundant System
- Remote Control/Monitor
- Controller Programming
- Open Door Kill Switch
- Extended Temp. Probe
- Heater
- Dry Contact
- Filter/Filter Frame
- Hazardous Location
- Custom Finish
- Diagnostics

Model	UL Type	BTU/Hour	Material	Voltage/Phase/Hz.	Running Amps	Max. Amb. Temp.	H x W x D	Unit Weight (lbs.)
NE08012612	12	8000	Powder coated steel	115/1/60	7.83	125°F	36" x 11.8" x 15.02"	102
NE08012604	4	8000	Powder coated steel	115/1/60	7.83	125°F	36" x 11.8" x 15.02"	102
NE0801264X	4X	8000	Stainless steel	115/1/60	7.83	125°F	36" x 11.8" x 15.02"	102
NE0801264XL4	4X	8000	Mill finish aluminum	115/1/60	7.83	125°F	36" x 11.8" x 15.02"	92
NE08023612	12	8000	Powder coated steel	230/1/60	4.8	125°F	36" x 11.8" x 15.02"	103
NE08023604	4	8000	Powder coated steel	230/1/60	4.8	125°F	36" x 11.8" x 15.02"	103
NE0802364X	4X	8000	Stainless steel	230/1/60	4.8	125°F	36" x 11.8" x 15.02"	103
NE0802364XL4	4X	8000	Mill finish aluminum	230/1/60	4.8	125°F	36" x 11.8" x 15.02"	93
NE08048612	12	8000	Powder coated steel	460/1/60	2.4	125°F	44.63" x 11.8" x 15.02"	142
NE08048604	4	8000	Powder coated steel	460/1/60	2.4	125°F	44.63" x 11.8" x 15.02"	142
NE0804864X	4X	8000	Stainless steel	460/1/60	2.4	125°F	44.63" x 11.8" x 15.02"	142
NE0804864XL5	4X	8000	Mill finish aluminum	460/1/60	2.4	125°F	44.63" x 11.8" x 15.02"	132

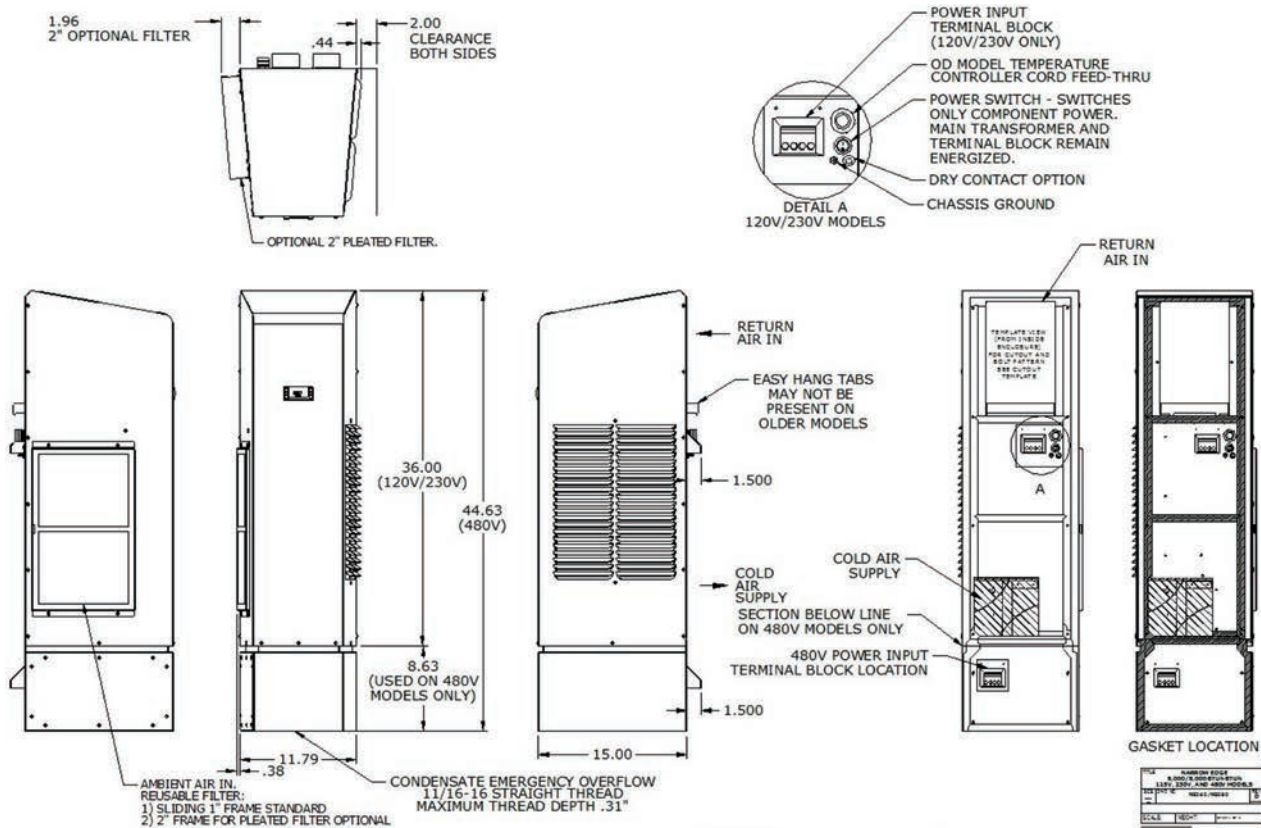
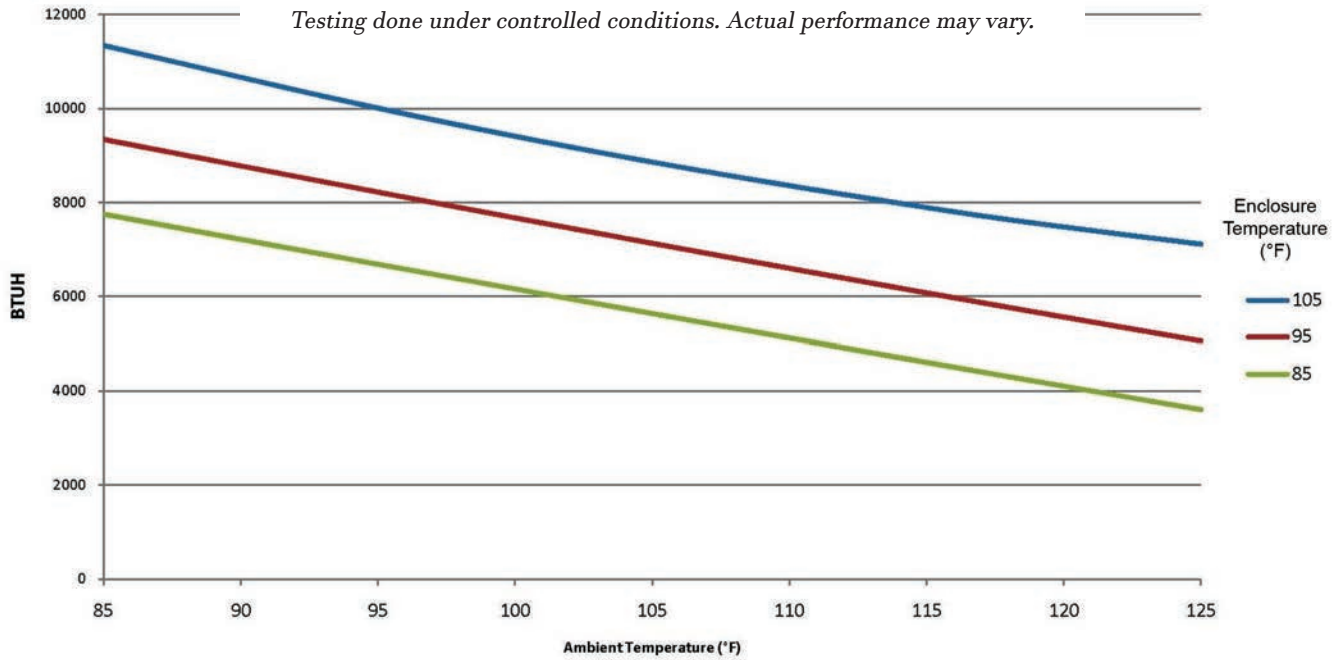

ATTENTION: If ordering a replacement for a Thermal Edge air conditioner, please include the part number and serial number of the unit being replaced in your order. This will ensure that we ship a replacement that is compatible with the cutout dimensions and power connection features of the older model. All information subject to change without notice.

8000 BTUH TOP MOUNT | INDOOR/OUTDOOR, UL TYPES 12, 4 & 4X AVAILABLE

Engineered & manufactured to endure the most difficult of environments and applications. Thermal Edge air conditioners will exceed environmental requirements in applications like Steel, Food Processing, Petro-Chemical, Cement, Paper & Pulp and Plastics.



OPTIONS:

- Low/High Ambient
- Remote Controller
- Corrosion Protection
- Redundant System
- Remote Control/Monitor
- Controller Programming
- Open Door Kill Switch
- Extended Temp. Probe
- Heater
- Dry Contact
- Filter/Filter Frame
- Hazardous Location
- Custom Finish
- Diagnostics

Digital Temperature Controller

- Programmable set point and temperature controls
- Visible Error and/or alarm messaging
- System status indication & keypad lockout function

Active Condensate Evaporation System

- Constant elimination of condensate
- Increases unit efficiency by pre-cooling refrigerant

Key Design Features

- Designed with rigid chassis and seam welded shroud
- Thoughtful interior design for easy maintenance
- Integrated lifting eyes

Unit Efficiency

- Highly efficient rotary compressor
- Fully insulated & sealed cabinet
- Thermal Expansion Valve to maintain cooling capacity over a broad ambient temperature range

Compressor Protection System

- High & Low refrigerant cutouts with fault indication
- Compressor anti short cycle protection
- Thermal overload protector
- Compressor run capacitors reduce power inrush, save energy and increase compressor life

Filter Free Operation

Model	UL Type	BTU/Hour	Material	Voltage/Phase/Hz.	Running Amps	Max. Amb. Temp.	H x W x D	Unit Weight (lbs.)
TM08112612	12	8000	Powder coated steel	115/1/60	11.6	131°F	15.6" x 26.3" x 20.2"	111
TM08112604	4	8000	Powder coated steel	115/1/60	11.6	131°F	15.6" x 30.6" x 20.2"	111
TM0811264X	4X	8000	Stainless steel	115/1/60	11.6	131°F	15.6" x 30.6" x 20.2"	111
TM0811264XL4	4X	8000	Mill finish aluminum	115/1/60	11.6	131°F	15.6" x 30.6" x 20.2"	101
TM08123612	12	8000	Powder coated steel	230/1/60	7.0	131°F	15.6" x 26.3" x 20.2"	111
TM08123604	4	8000	Powder coated steel	230/1/60	7.0	131°F	15.6" x 30.6" x 20.2"	111
TM0812364X	4X	8000	Stainless steel	230/1/60	7.0	131°F	15.6" x 30.6" x 20.2"	111
TM0812364XL4	4X	8000	Mill finish aluminum	230/1/60	7.0	131°F	15.6" x 30.6" x 20.2"	101
TM08148612	12	8000	Powder coated steel	460/1/60	3.5	131°F	15.6" x 26.3" x 20.2"	154
TM08148604	4	8000	Powder coated steel	460/1/60	3.5	131°F	15.6" x 30.6" x 20.2"	154
TM0814864X	4X	8000	Stainless steel	460/1/60	3.5	131°F	15.6" x 30.6" x 20.2"	154
TM0814864XL4	4X	8000	Mill finish aluminum	460/1/60	3.5	131°F	15.6" x 30.6" x 20.2"	144

Testing done under controlled conditions. Actual performance may vary.

TM081

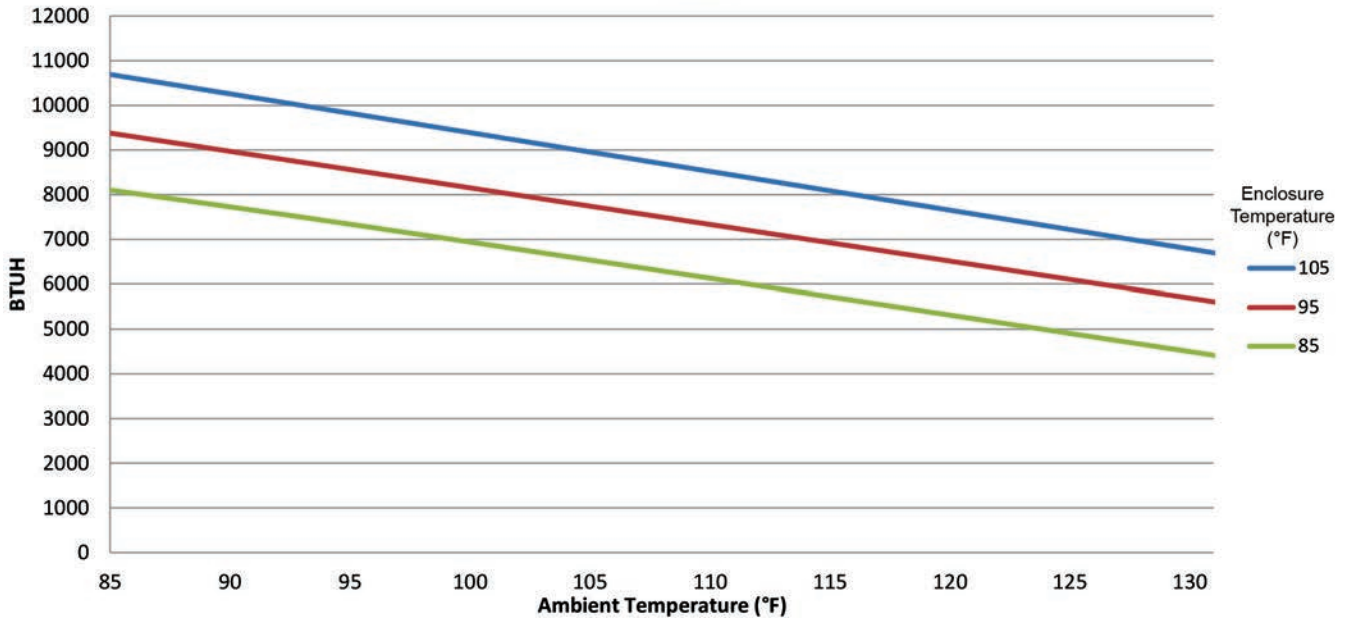

TM081 60 Hz unit test results running on 50 Hz power source

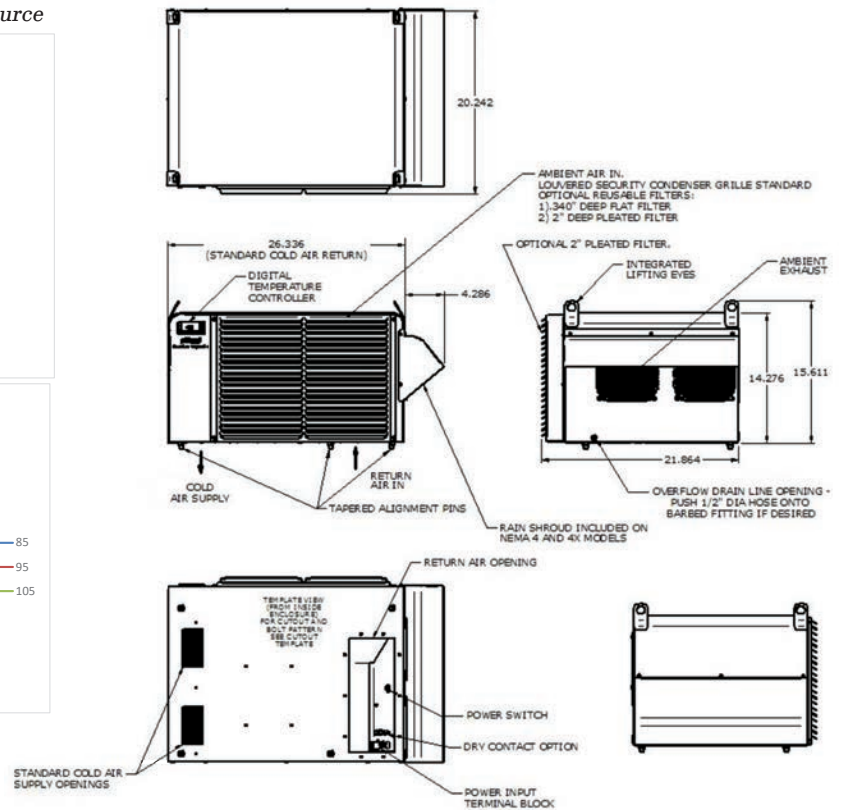
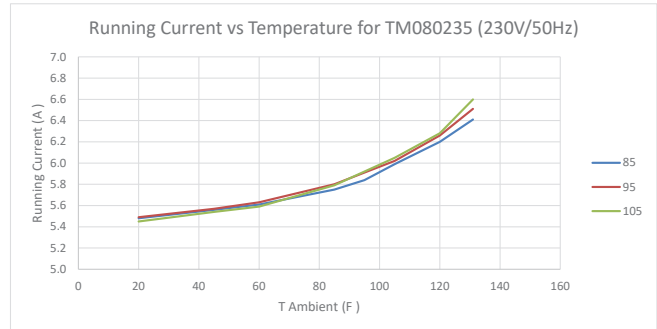
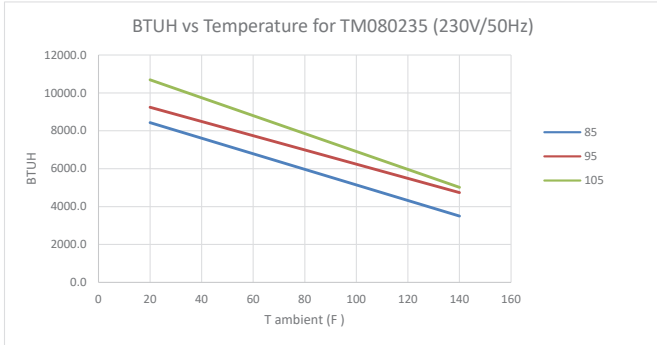

ATTENTION: If ordering a replacement for a Thermal Edge air conditioner, please include the part number and serial number of the unit being replaced in your order. This will ensure that we ship a replacement that is compatible with the cutout dimensions and power connection features of the older model. All information subject to change without notice.

10,000 BTUH | INDOOR/OUTDOOR, UL TYPES 12, 4 & 4X AVAILABLE

Engineered & manufactured to endure the most difficult of environments and applications.

Thermal Edge air conditioners will exceed environmental requirements in applications like Steel, Food Processing, Petro-Chemical, Cement, Paper & Pulp and Plastics.



Digital Temperature Controller

- Programmable set point and temperature controls
- Visible Error and/or alarm messaging
- System status indication & keypad lockout function

Active Condensate Evaporation System

- Constant elimination of condensate
- Increases unit efficiency by pre-cooling refrigerant

Key Design Features

- Sloped top to allow for water runoff
- Designed with rigid chassis and seam welded shroud
- Thoughtful interior design for easy maintenance

Unit Efficiency

- Temperature operated condenser fan reduces power inrush and saves energy
- Highly efficient rotary compressor
- Fully insulated & sealed cabinet
- Thermal Expansion Valve to maintain cooling capacity over a broad ambient temperature range

Compressor Protection System

- High & Low refrigerant cutouts with fault indication
- Compressor anti short cycle protection
- Thermal overload protector
- Compressor run capacitors reduce power inrush, save energy and increase compressor life

OPTIONS:

- Low/High Ambient
- Remote Controller
- Corrosion Protection
- Redundant System
- Remote Control/Monitor
- Controller Programming
- Open Door Kill Switch
- Extended Temp. Probe
- Heater
- Dry Contact
- Filter/Filter Frame
- Hazardous Location
- Custom Finish
- Diagnostics
- Hard Start Kit

Model	UL Type	BTU/Hour	Material	Voltage/Phase/Hz.	Running Amps	Max. Amb. Temp.	H x W x D	Unit Weight (lbs.)
HC10112612	12	10,000	Powder coated steel	115/1/60	19.4	131°F	48" x 15.86" x 15.03"	162
HC10112604	4	10,000	Powder coated steel	115/1/60	19.4	131°F	48" x 15.86" x 15.03"	162
HC1011264X	4X	10,000	Stainless steel	115/1/60	19.4	131°F	48" x 15.86" x 15.03"	162
HC1011264XL4	4X	10,000	Mill finish aluminum	115/1/60	19.4	131°F	48" x 15.86" x 15.03"	152
HC10123612	12	10,000	Powder coated steel	230/1/60	8.2	131°F	48" x 15.86" x 15.03"	166
HC10123604	4	10,000	Powder coated steel	230/1/60	8.2	131°F	48" x 15.86" x 15.03"	166
HC1012364X	4X	10,000	Stainless steel	230/1/60	8.2	131°F	48" x 15.86" x 15.03"	166
HC1012364XL4	4X	10,000	Mill finish aluminum	230/1/60	8.2	131°F	48" x 15.86" x 15.03"	156
HC10148612	12	10,000	Powder coated steel	460/1/60	4.1	131°F	57.6" x 15.86" x 15.03"	232
HC10148604	4	10,000	Powder coated steel	460/1/60	4.1	131°F	57.6" x 15.86" x 15.03"	232
HC1014864X	4X	10,000	Stainless steel	460/1/60	4.1	131°F	57.6" x 15.86" x 15.03"	232
HC1014864XL5	4X	10,000	Mill finish aluminum	460/1/60	4.1	131°F	57.6" x 15.86" x 15.03"	222

Testing done under controlled conditions. Actual performance may vary.

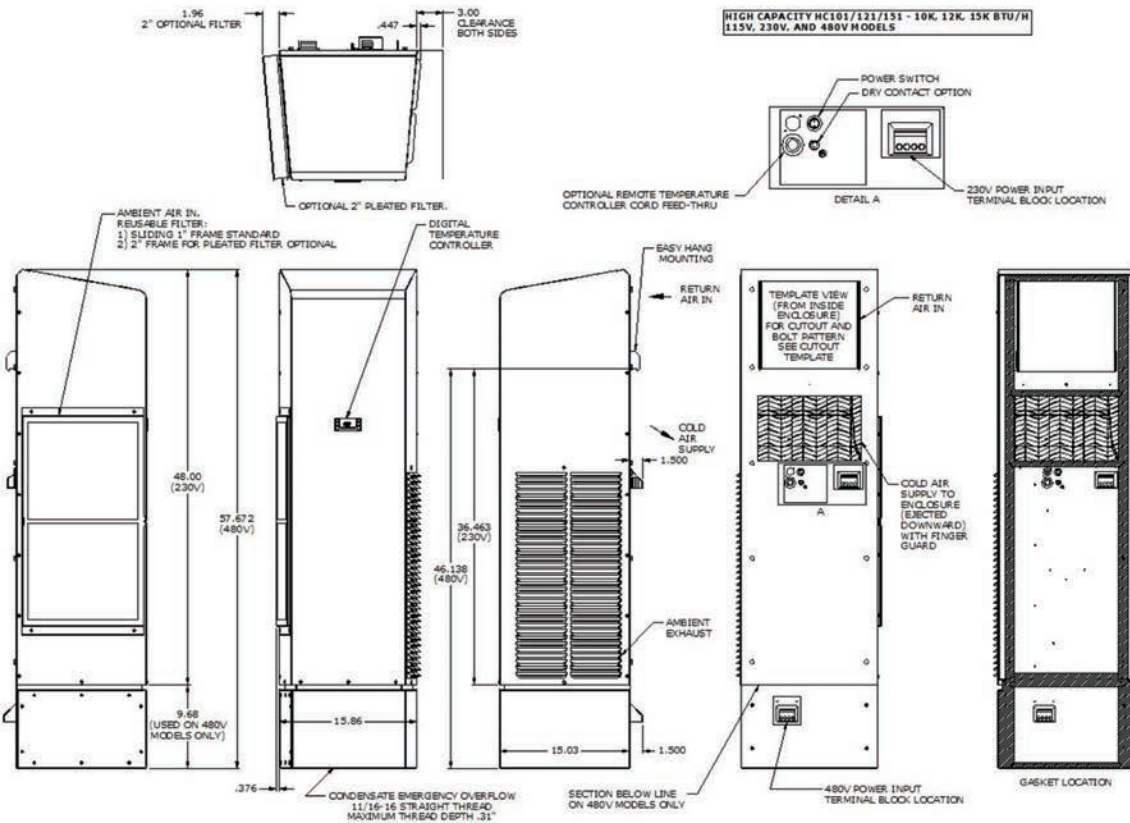
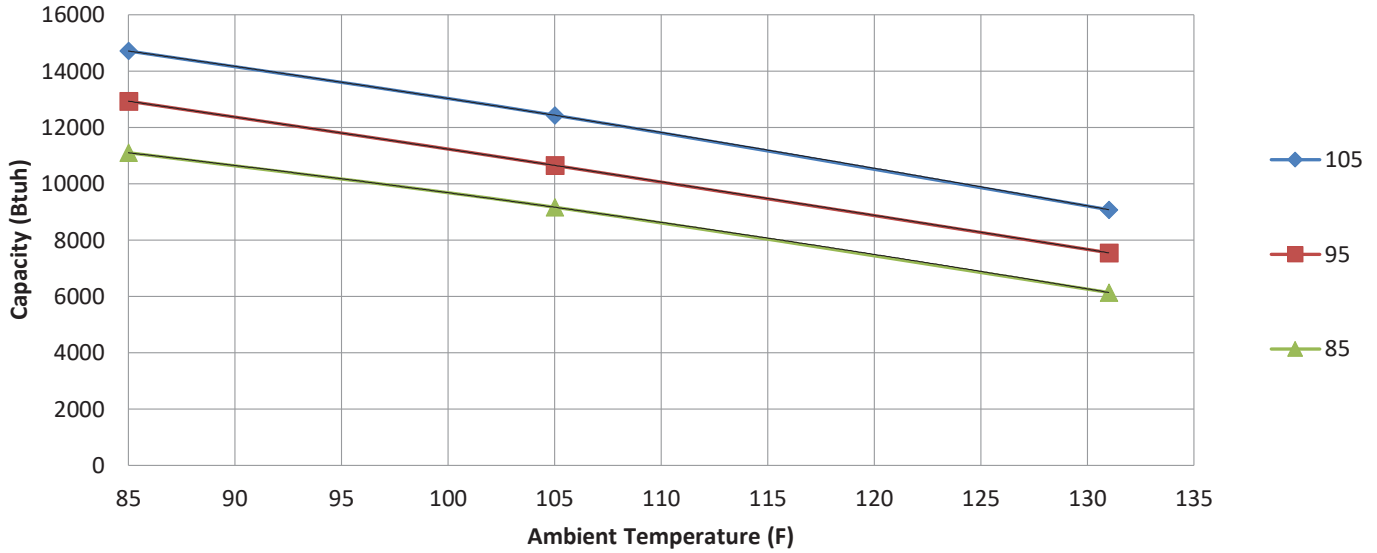

ATTENTION: If ordering a replacement for a Thermal Edge air conditioner, please include the part number and serial number of the unit being replaced in your order. This will ensure that we ship a replacement that is compatible with the cutout dimensions and power connection features of the older model. All information subject to change without notice.

12,000 BTUH | INDOOR/OUTDOOR, UL TYPES 12, 4 & 4X AVAILABLE

Engineered & manufactured to endure the most difficult of environments and applications.

Thermal Edge air conditioners will exceed environmental requirements in applications like Steel, Food Processing, Petro-Chemical, Cement, Paper & Pulp and Plastics.



Digital Temperature Controller

- Programmable set point and temperature controls
- Visible Error and/or alarm messaging
- System status indication & keypad lockout function

Active Condensate Evaporation System

- Constant elimination of condensate
- Increases unit efficiency by pre-cooling refrigerant

Key Design Features

- Sloped top to allow for water runoff
- Designed with rigid chassis and seam welded shroud
- Thoughtful interior design for easy maintenance

Unit Efficiency

- Temperature operated condenser fan reduces power inrush and saves energy
- Highly efficient rotary compressor
- Fully insulated & sealed cabinet
- Thermal Expansion Valve to maintain cooling capacity over a broad ambient temperature range

Compressor Protection System

- High & Low refrigerant cutouts with fault indication
- Compressor anti short cycle protection
- Thermal overload protector
- Compressor run capacitors reduce power inrush, save energy and increase compressor life

OPTIONS:

- Low/High Ambient
- Remote Controller
- Corrosion Protection
- Redundant System
- Remote Control/Monitor
- Controller Programming
- Open Door Kill Switch
- Extended Temp. Probe
- Heater
- Dry Contact
- Filter/Filter Frame
- Hazardous Location
- Custom Finish
- Diagnostics
- Hard Start Kit

Model	UL Type	BTU/Hour	Material	Voltage/Phase/Hz.	Running Amps	Max. Amb. Temp.	H x W x D	Unit Weight (lbs.)
HC12112612	12	12,000	Powder coated steel	115/1/60	19.4	131°F	48" x 15.86" x 15.03"	167
HC12112604	4	12,000	Powder coated steel	115/1/60	19.4	131°F	48" x 15.86" x 15.03"	167
HC1211264X	4X	12,000	Stainless steel	115/1/60	19.4	131°F	48" x 15.86" x 15.03"	167
HC1211264XL4	4X	12,000	Mill finish aluminum	115/1/60	19.4	131°F	48" x 15.86" x 15.03"	157
HC12123612	12	12,000	Powder coated steel	230/1/60	8.2	131°F	48" x 15.86" x 15.03"	163
HC12123604	4	12,000	Powder coated steel	230/1/60	8.2	131°F	48" x 15.86" x 15.03"	163
HC1212364X	4X	12,000	Stainless steel	230/1/60	8.2	131°F	48" x 15.86" x 15.03"	163
HC1212364XL4	4X	12,000	Mill finish aluminum	230/1/60	8.2	131°F	48" x 15.86" x 15.03"	153
HC12148612	12	12,000	Powder coated steel	460/1/60	4.1	131°F	57.6" x 15.86" x 15.03"	237
HC12148604	4	12,000	Powder coated steel	460/1/60	4.1	131°F	57.6" x 15.86" x 15.03"	237
HC1214864X	4X	12,000	Stainless steel	460/1/60	4.1	131°F	57.6" x 15.86" x 15.03"	237
HC1214864XL5	4X	12,000	Mill finish aluminum	460/1/60	4.1	131°F	57.6" x 15.86" x 15.03"	227

Testing done under controlled conditions. Actual performance may vary.

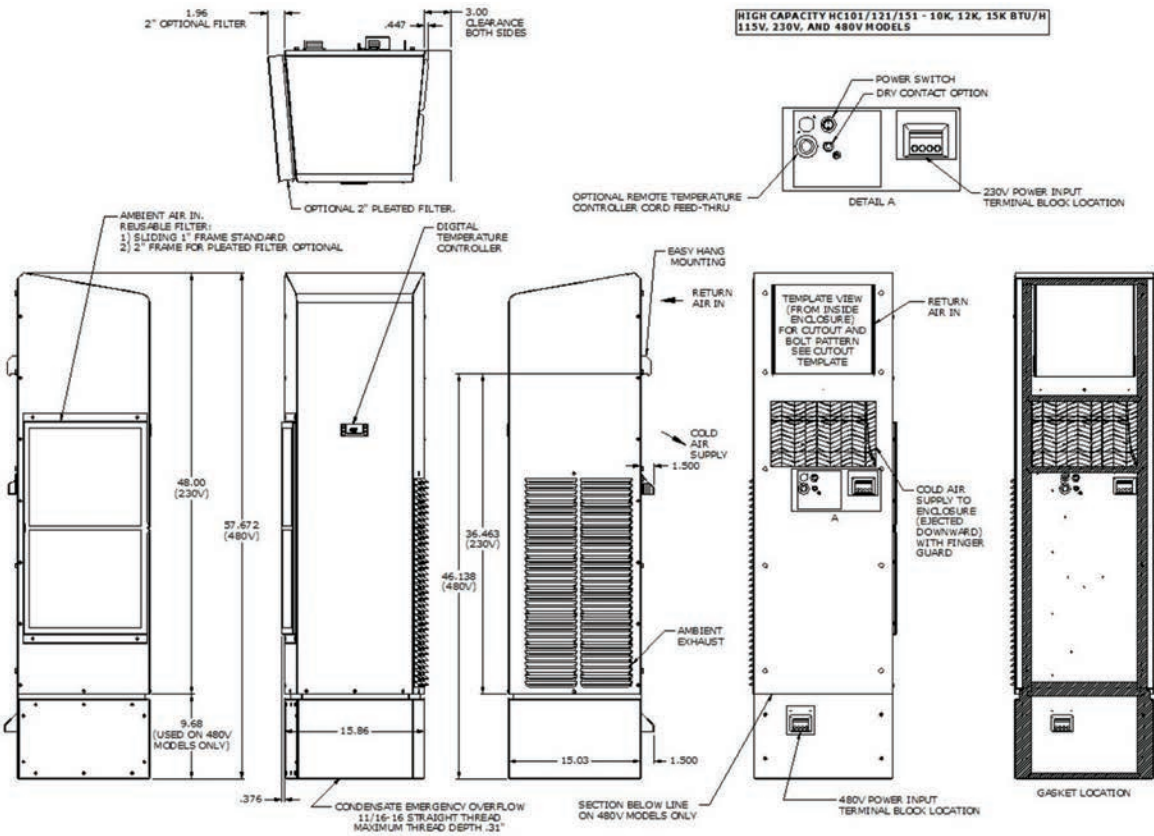
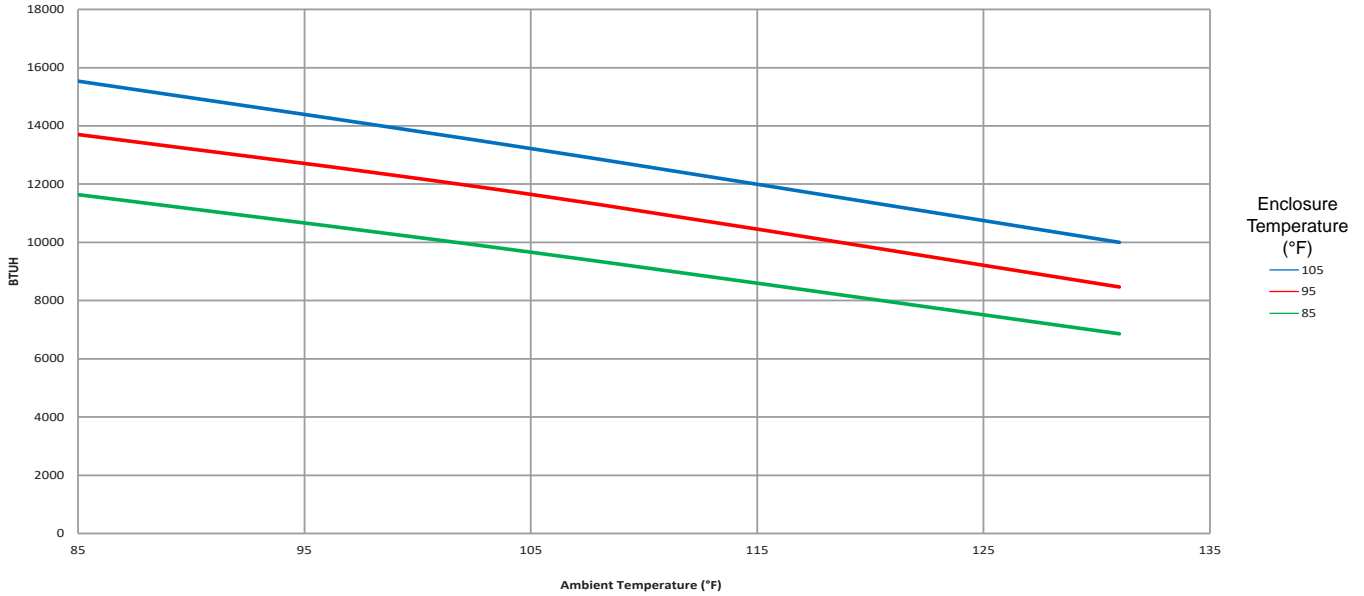

ATTENTION: If ordering a replacement for a Thermal Edge air conditioner, please include the part number and serial number of the unit being replaced in your order. This will ensure that we ship a replacement that is compatible with the cutout dimensions and power connection features of the older model. All information subject to change without notice.

15,000 BTUH

INDOOR/OUTDOOR, UL TYPES 12, 4 & 4X AVAILABLE

Engineered & manufactured to endure the most difficult of environments and applications.

Thermal Edge air conditioners will exceed environmental requirements in applications like Steel, Food Processing, Petro-Chemical, Cement, Paper & Pulp and Plastics



Digital Temperature Controller

- Programmable set point and temperature controls
- Visible Error and/or alarm messaging
- System status indication & keypad lockout function

Active Condensate Evaporation System

- Constant elimination of condensate
- Increases unit efficiency by pre-cooling refrigerant

Key Design Features

- Sloped top to allow for water runoff
- Designed with rigid chassis and seam welded shroud
- Thoughtful interior design for easy maintenance

Unit Efficiency

- Temperature operated condenser fan reduces power inrush and saves energy
- Highly efficient rotary compressor
- Fully insulated & sealed cabinet
- Thermal Expansion Valve to maintain cooling capacity over a broad ambient temperature range

Compressor Protection System

- High & Low refrigerant cutouts with fault indication
- Compressor anti short cycle protection
- Thermal overload protector
- Compressor run capacitors reduce power inrush, save energy and increase compressor life

OPTIONS:

- Low/High Ambient
- Remote Controller
- Corrosion Protection
- Redundant System
- Remote Control/Monitor
- Controller Programming
- Open Door Kill Switch
- Extended Temp. Probe
- Heater
- Dry Contact
- Filter/Filter Frame
- Hazardous Location
- Custom Finish
- Diagnostics
- Hard Start Kit

Model	UL Type	BTU/Hour	Material	Voltage/Phase/Hz.	Running Amps	Max. Amb. Temp.	H x W x D	Unit Weight (lbs.)
HC15123612	12	15,000	Powder coated steel	230/1/60	9.93	140°F	48" x 15.86" x 15.03"	170
HC15123604	4	15,000	Powder coated steel	230/1/60	9.93	140°F	48" x 15.86" x 15.03"	170
HC1512364X	4X	15,000	Stainless steel	230/1/60	9.93	140°F	48" x 15.86" x 15.03"	170
HC1512364XL4	4X	15,000	Mill finish aluminum	230/1/60	9.93	140°F	48" x 15.86" x 15.03"	160
HC15148612	12	15,000	Powder coated steel	460/1/60	5.21	140°F	57.6" x 15.86" x 15.03"	247
HC15148604	4	15,000	Powder coated steel	460/1/60	5.21	140°F	57.6" x 15.86" x 15.03"	247
HC1514864X	4X	15,000	Stainless steel	460/1/60	5.21	140°F	57.6" x 15.86" x 15.03"	247
HC1514864XL5	4X	15,000	Mill finish aluminum	460/1/60	5.21	140°F	57.6" x 15.86" x 15.03"	237

Testing done under controlled conditions. Actual performance may vary.

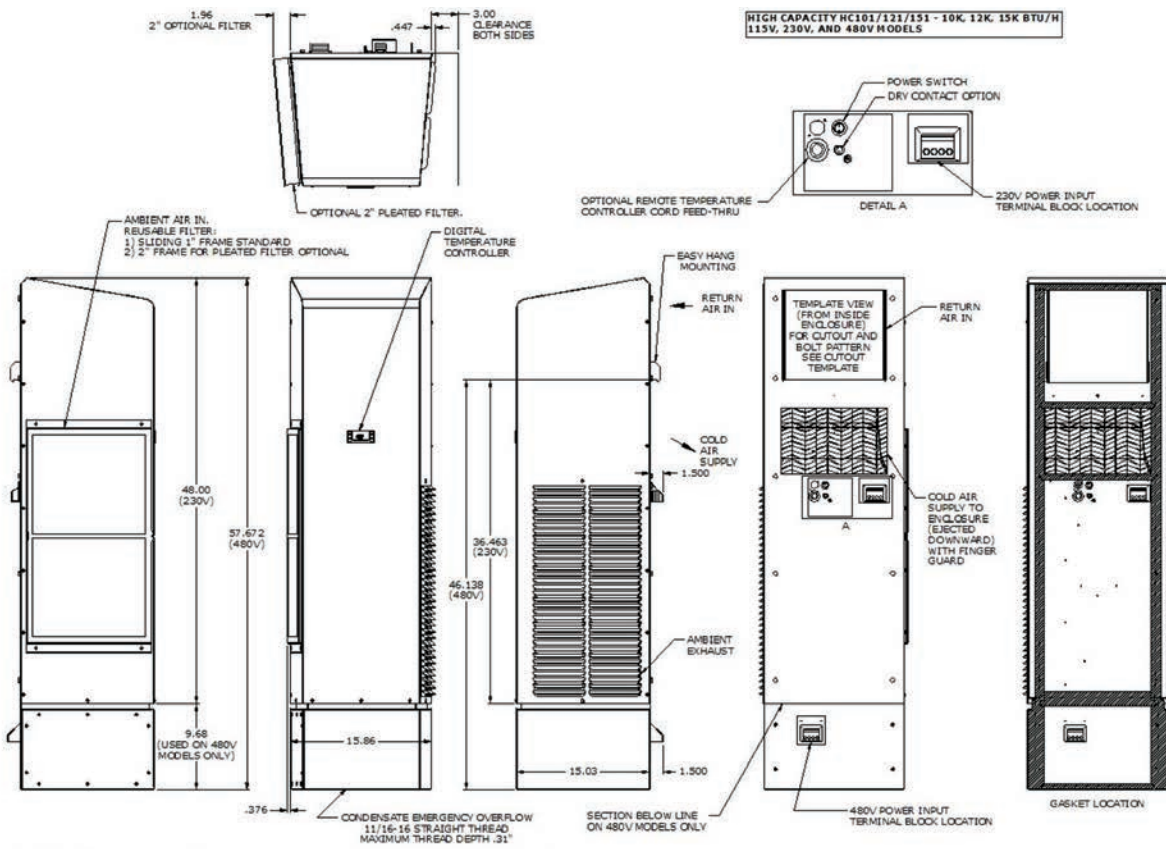
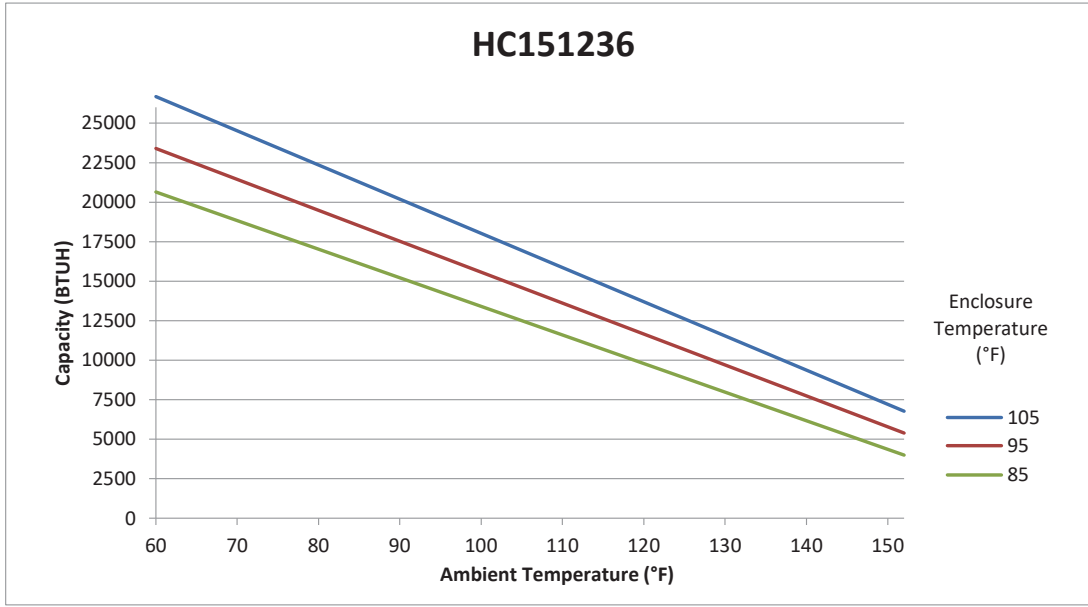

ATTENTION: If ordering a replacement for a Thermal Edge air conditioner, please include the part number and serial number of the unit being replaced in your order. This will ensure that we ship a replacement that is compatible with the cutout dimensions and power connection features of the older model. All information subject to change without notice.

20,000 BTUH | INDOOR/OUTDOOR, UL TYPES 12, 4 & 4X AVAILABLE

Engineered & manufactured to endure the most difficult of environments and applications.

Thermal Edge air conditioners will exceed environmental requirements in applications like Steel, Food Processing, Petro-Chemical, Cement, Paper & Pulp and Plastics



Digital Temperature Controller

- Programmable set point and temperature controls
- Visible Error and/or alarm messaging
- System status indication & keypad lockout function

Active Condensate Evaporation System

- Constant elimination of condensate
- Increases unit efficiency by pre-cooling refrigerant

Key Design Features

- Sloped top to allow for water runoff
- Designed with rigid chassis and seam welded shroud
- Thoughtful interior design for easy maintenance

Unit Efficiency

- Temperature operated condenser fan reduces power inrush and saves energy
- Highly efficient rotary compressor
- Fully insulated & sealed cabinet
- Thermal Expansion Valve to maintain cooling capacity over a broad ambient temperature range

Compressor Protection System

- High & Low refrigerant cutouts with fault indication
- Compressor anti short cycle protection
- Thermal overload protector
- Compressor run capacitors reduce power inrush, save energy and increase compressor life

OPTIONS:

- Low/High Ambient
- Remote Controller
- Corrosion Protection
- Redundant System
- Remote Control/Monitor
- Controller Programming
- Open Door Kill Switch
- Extended Temp. Probe
- Heater
- Dry Contact
- Filter/Filter Frame
- Hazardous Location
- Custom Finish
- Diagnostics
- Hard Start Kit
- Will run on 50 Hz Power

Model	UL Type	Material	Voltage/Phase/Hz.	Running Amps	Max. Amb. Temp.	H x W x D	Unit Weight (lbs.)
HC20C23612	12	Powder coated steel	230/1/60	12.47	140°F	48" x 15.86" x 15.03"	170
HC20C23604	4	Powder coated steel	230/1/60	12.47	140°F	48" x 15.86" x 15.03"	170
HC20C2364X	4X	Stainless steel	230/1/60	12.47	140°F	48" x 15.86" x 15.03"	170
HC20C2364XL4	4X	Mill finish aluminum	230/1/60	12.47	140°F	48" x 15.86" x 15.03"	160
HC20C48612	12	Powder coated steel	460/1/60	6.3	140°F	57.6" x 15.86" x 15.03"	247
HC20C48604	4	Powder coated steel	460/1/60	6.3	140°F	57.6" x 15.86" x 15.03"	247
HC20C4864X	4X	Stainless steel	460/1/60	6.3	140°F	57.6" x 15.86" x 15.03"	247
HC20C4864XL5	4X	Mill finish aluminum	460/1/60	6.3	140°F	57.6" x 15.86" x 15.03"	237

HC20C 240V (50/60 Hz)

Testing done under controlled conditions. Actual performance may vary.

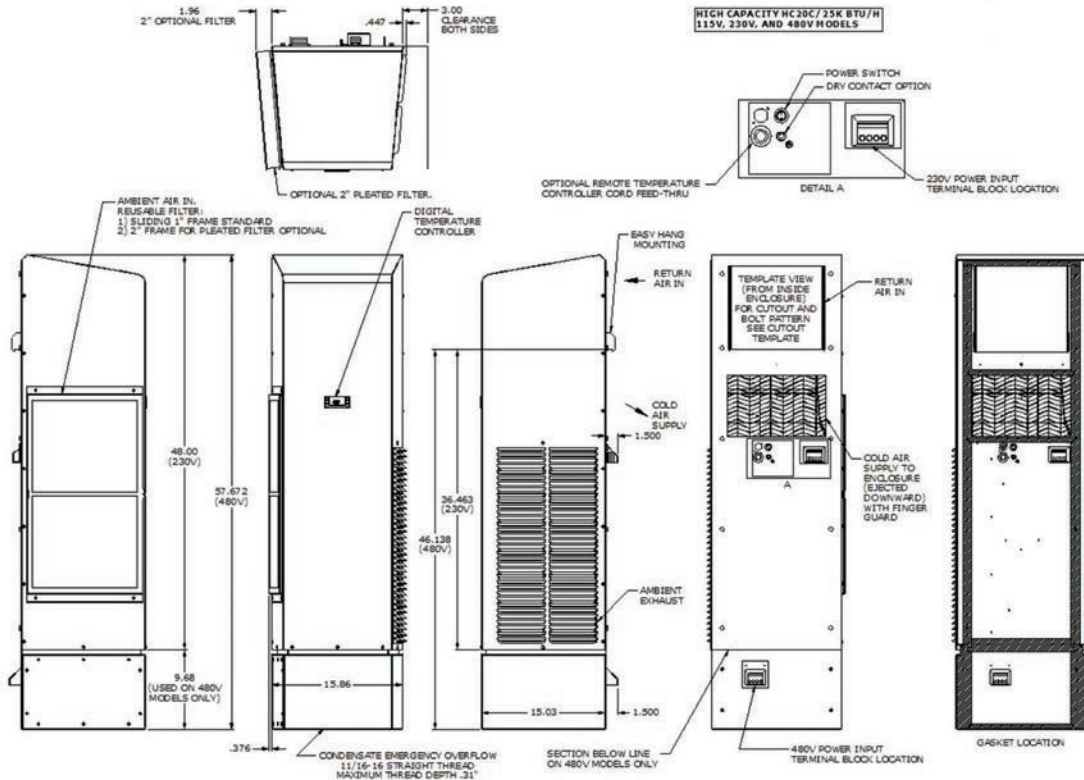
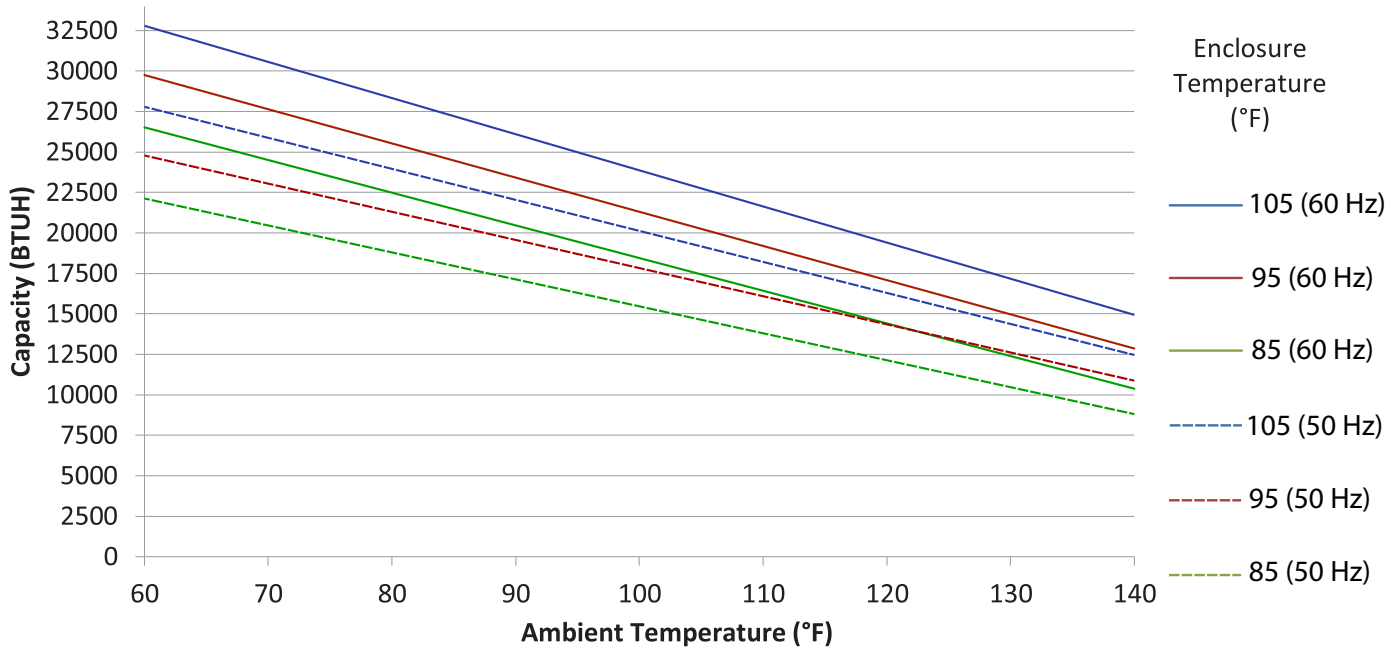

ATTENTION: If ordering a replacement for a Thermal Edge air conditioner, please include the part number and serial number of the unit being replaced in your order. This will ensure that we ship a replacement that is compatible with the cutout dimensions and power connection features of the older model. All information subject to change without notice.

4/18/2024



Thermal Edge Inc.TM

TEMPERATURE CONTROL SOLUTIONS FOR ELECTRICAL ENCLOSURES

50 HZ ENCLOSURE AIR CONDITIONERS

Fully Integrated Condensate Evaporation Package

Programmable Digital Controller

Thermal Expansion Valve

Narrow Design To Fit Onto A 12" Enclosure

Energy Efficient - Low Running Amps



MADE IN AMERICA MATTERS...



RESOURCES

[HTTPS://THERMALEDGE.COM/RESOURCES/](https://thermaledge.com/resources/)

Browse the wide selection of online resources available on the Thermal Edge website to assist you in learning about and understanding our products.

STANDARDS & CERTIFICATIONS

Learn more about Thermal Edge standards & certifications.

[www.thermaledge.com/
resource-type/standards-certifications/](http://www.thermaledge.com/resource-type/standards-certifications/)

SALES

Find your Thermal Edge sales specialist or a local representative by state. A link is available to open a new credit account.

[www.thermaledge.com/
contact-us/sales-team/](http://www.thermaledge.com/contact-us/sales-team/)

ETM CALCULATOR

Ensure that you select the right product for your electrical enclosure by using this calculator.

[www.thermaledge.com/enclosure-
temperature-management-calculator/](http://www.thermaledge.com/enclosure-temperature-management-calculator/)

LITERATURE AND USER MANUALS

Learn more about Thermal Edge products by downloading our product brochures, templates, drawings, manuals and much more.

[www.thermaledge.com/
resources/literature/](http://www.thermaledge.com/resources/literature/)

SUPPORT

Visit our support center to submit a support request or speak to a support representative.

[www.thermaledge.com/
contact-us/support-team/](http://www.thermaledge.com/contact-us/support-team/)

CASE STUDIES

Learn how Thermal Edge enclosure cooling systems have given customers a more reliable and efficient method for their electrical cooling needs.

[www.thermaledge.com/
resource-type/case-studies/](http://www.thermaledge.com/resource-type/case-studies/)

VIDEOS

Learn more about technology behind Thermal Edge cooling solutions by watching our online videos. We have videos that demonstrate our closed loop cooling technology, condensate management and more.

[www.thermaledge.com/
resources/videos/](http://www.thermaledge.com/resources/videos/)

CONTACT THERMAL EDGE

If you have questions that you cannot find answers to on our website, we have in-house customer care, technical services, design engineers, and application sales specialists that will be able to answer any questions that you may have regarding Thermal Edge products.

www.thermaledge.com/contact-us/

WHITE PAPERS

Learn about electrical enclosure cooling solutions by downloading our white papers. If you are still searching for the right enclosure cooling system for your application, we have a white paper just for you.

[www.thermaledge.com/
resource-type/white-papers/](http://www.thermaledge.com/resource-type/white-papers/)



WHAT MAKES AN AIR CONDITIONER A THERMAL EDGE AIR CONDITIONER?

There are three critical features that make a Thermal Edge Enclosure Air Conditioner different from any other line of air conditioners. Standard on Every Unit:

DRIP-FREE CONDENSATE REMOVAL IS NOT OPTIONAL

Condensate Evaporation Is Standard On Every Unit... NO DRAIN TUBE IS NEEDED

DIGITAL, PROGRAMMABLE CONTROLLER:

- Built in alarms and alerts
- Will operate heating & cooling
- Ethernet, Modbus RTU and EtherNet/IP communication options
- Remote controller option places controller inside cabinet

THERMAL EXPANSION VALVE CONTROLS THE FLOW

Thermal Expansion Valves balance and modulate the refrigerant flow to the heat load by sensing the temperature of the refrigerant leaving the evaporator.

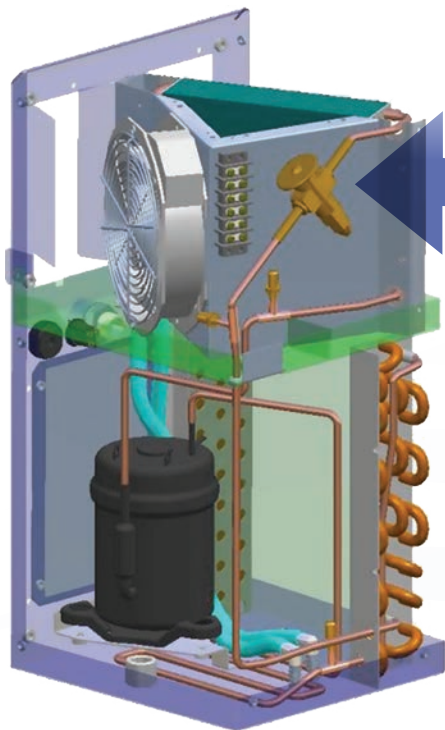

NO WATER DRIPS
FROM THERMAL EDGE
ENCLOSURE AIR
CONDITIONERS



ENGINEERED AND MANUFACTURED

to endure the most difficult of environments and applications. Thermal Edge air conditioners will exceed environmental requirements in applications like Steel, Food Processing, Petro-Chemical, Cement, Paper and Pulp and Plastics.



CS SERIES AIR CONDITIONERS

Smallest 2000 BTUH available

- Active Condensate Evaporation is standard
- Fits on a 7" or 10" deep enclosure
- Available in UL Types 12, 4, 4X
- Fully programmable digital controller with temperature and pressure monitors for a smarter air conditioner



NE SERIES AIR CONDITIONERS

Active Condensate Evaporation is standard

- Fits on a 12" deep enclosure
- Available in UL Types 12, 4, 4X and Hazardous Environment applications
- Fully programmable digital controller with temperature and pressure monitors for a smarter air conditioner
- 1000 BTUH
- 1500 BTUH
- 2000 BTUH
- 3000 BTUH
- 5000 BTUH
- 6000 BTUH



HC SERIES AIR CONDITIONERS

Active Condensate Evaporation is standard

- Available in UL Types 12, 4, 4X and Hazardous Environment applications
- Fully programmable digital controller with temperature and pressure monitors for a smarter air conditioner
- 115V, 230V, 460V
- 8000 BTUH
- 10,000 BTUH
- 12,000 BTUH
- 20,000 BTUH



50 HZ AIR CONDITIONER PRODUCT LINE

Model	BTU/Hour	Voltage/ Phase/Hz	Running Amps	Max. Ambient Temp	Max. Integrated Heat (Watts)	H x W x D	Unit Weight
CS011105	1,000	100/1/50	2.7	125°F	350	17" x 7" x 7"	31
NE010105	1,000	100/1/50	2.3	125°F	NA	22" x 11.8" x 8.5"	53
NE010205	1,000	200/1/50	1.9	125°F	NA	22" x 11.8" x 8.5"	53
NE015105	1,500	100/1/50	2.4	125°F	NA	22" x 11.8" x 8.5"	53
NE015205	1,500	200/1/50	1.9	125°F	NA	22" x 11.8" x 8.5"	53
CS020235	2,000	230/1/50	1.7	131°F	500	20" x 10" x 10"	49
NE020105	2,000	100/1/50	5.2	125°F	1000	32" x 11.8" x 9.5"	65
NE020235	2,000	230/1/50	1.7	125°F	1000	32" x 11.8" x 9.5"	65
NE020385	2,000	380/1/50	1.4	125°F	1000	32" x 11.8" x 9.5"	99
NE020405	2,000	400/1/50	1.3	125°F	1000	38" x 11.8" x 9.5"	99
NE020415	2,000	415/1/50	1.25	125°F	1000	38" x 11.8" x 9.5"	99
NE030105	3,000	100/1/50	5.0	125°F	1000	38" x 11.8" x 9.5"	66
NE030205	3,000	200/1/50	3.07	125°F	1000	38" x 11.8" x 9.5"	99
NE030385	3,000	380/1/50	1.32	125°F	1000	38" x 11.8" x 9.5"	99
NE030405	3,000	400/1/50	1.28	125°F	1000	38" x 11.8" x 9.5"	99
NE030415	3,000	415/1/50	1.2	125°F	1000	38" x 11.8" x 9.5"	99
NE050237	5,000	230/1/50-60	4.0/3.1	131°F	1000	44.63" x 11.8" x 15.1"	170
NE050235	5,000	230/1/50	3.4	131°F	1000	36" x 11.8" x 15.1"	92
NE050385	5,000	380/1/50	2.1	131°F	1000	44.63" x 11.8" x 15.1"	136
NE050405	5,000	400/1/50	1.9	131°F	1000	44.63" x 11.8" x 15.1"	136
NE050415	5,000	415/1/50	1.9	131°F	1000	44.63" x 11.8" x 15.1"	136

50 HZ AIR CONDITIONER PRODUCT LINE

(CONTINUED)

Model	BTU/Hour	Voltage/ Phase/Hz	Running Amps	Max. Ambient Temp	Max. Integrated Heat (Watts)	H x W x D	Unit Weight
NE060237	6,000	230/1/50-60	4.2/3.7	131°F	1000	44.63" x 11.8" x 15.1"	170
NE060235	6,000	230/1/50	4.0	131°F	1000	36" x 11.8" x 15.1"	98
NE060385	6,000	380/1/50	2.4	131°F	1000	44.63" x 11.8" x 15.1"	142
NE060405	6,000	400/1/50	2.3	131°F	1000	44.63" x 11.8" x 15.1"	142
NE060415	6,000	415/1/50	2.2	131°F	1000	44.63" x 11.8" x 15.1"	142
HC080235	8,000	230/1/50	7.1	125°F	1000	48" x 15.9" x 15.1"	166
HC080385	8,000	380/1/50	4.3	125°F	1000	57.6" x 15.9" x 15.1"	232
HC080405	8,000	400/1/50	4.1	125°F	1000	57.6" x 15.9" x 15.1"	232
HC080415	8,000	415/1/50	3.8	125°F	1000	57.6" x 15.9" x 15.1"	232
HC101235	10,000	230/1/50	6.4	131°F	1500	48" x 15.9" x 15.1"	166
HC101385	10,000	380/1/50	3.9	131°F	1500	57.6" x 15.9" x 15.1"	232
HC101405	10,000	400/1/50	3.7	131°F	1500	57.6" x 15.9" x 15.1"	232
HC101415	10,000	415/1/50	3.6	131°F	1500	57.6" x 15.9" x 15.1"	232
HC121235	12,000	230/1/50	8.6	131°F	1500	48" x 15.9" x 15.1"	163
HC121385	12,000	380/1/50	5.2	131°F	1500	57.6" x 15.9" x 15.1"	237
HC121405	12,000	400/1/50	4.9	131°F	1500	57.6" x 15.9" x 15.1"	237
HC121415	12,000	415/1/50	4.8	131°F	1500	57.6" x 15.9" x 15.1"	237



1000 BTUH | INDOOR/OUTDOOR, UL TYPES 12, 4 & 4X AVAILABLE

Engineered & manufactured to endure the most difficult of environments and applications. Thermal Edge air conditioners will exceed environmental requirements in applications like Steel, Food Processing, Petro-Chemical, Cement, Paper & Pulp and Plastics. The CS011 uses a unique 3 coil design providing high capacity cooling while utilizing air intake from either side. Dual intake allows for mounting on a wall mounted enclosure on the right or left side of your enclosure.



Digital Temperature Controller

- Programmable set point and temperature controls
- Visible Error and/or alarm messaging
- System status indication & keypad lockout function

Active Condensate Evaporation System

- Constant elimination of condensate
- Increases unit efficiency by pre-cooling refrigerant

Key Design Features

- Designed with rigid chassis and seam welded shroud
- Thoughtful interior design for easy maintenance
- Narrow body style fits on 8" deep enclosure
- Filter free design

Unit Efficiency

- Temperature operated condenser fan reduces power inrush and saves energy
- Highly efficient rotary compressor
- Fully insulated & sealed cabinet
- Thermal Expansion Valve to maintain cooling capacity over a broad ambient temperature range

Compressor Protection System

- High & Low refrigerant cutouts with fault indication
- Compressor anti short cycle protection
- Thermal overload protector
- Compressor run capacitors reduce power inrush, save energy and increase compressor life

OPTIONS:

- Low/High Ambient
- Remote Controller
- Corrosion Protection
- Remote Control/Monitor
- Controller Programming
- Open Door Kill Switch
- Extended Temp. Probe
- Heater
- Dry Contact
- Custom Finish

Model	UL Type	BTU/Hour	Material	Voltage/Phase/Hz.	Running Amps	Max. Amb. Temp.	H x W x D	Weight (lbs.) Unit/Ship
CS01110512	12	1000	Powder coated steel	100/1/50	2.7	125°F	17" x 7" x7"	31 / 45
CS01110504	4	1000	Powder coated steel	100/1/50	2.7	125°F	17" x 7" x7"	31 / 45
CS0111054X	4X	1000	Stainless steel	100/1/50	2.7	125°F	17" x 7" x7"	31 / 45
CS0111054XL4	4X	1000	Mill finish aluminum	100/1/50	2.7	125°F	17" x 7" x7"	24 / 38

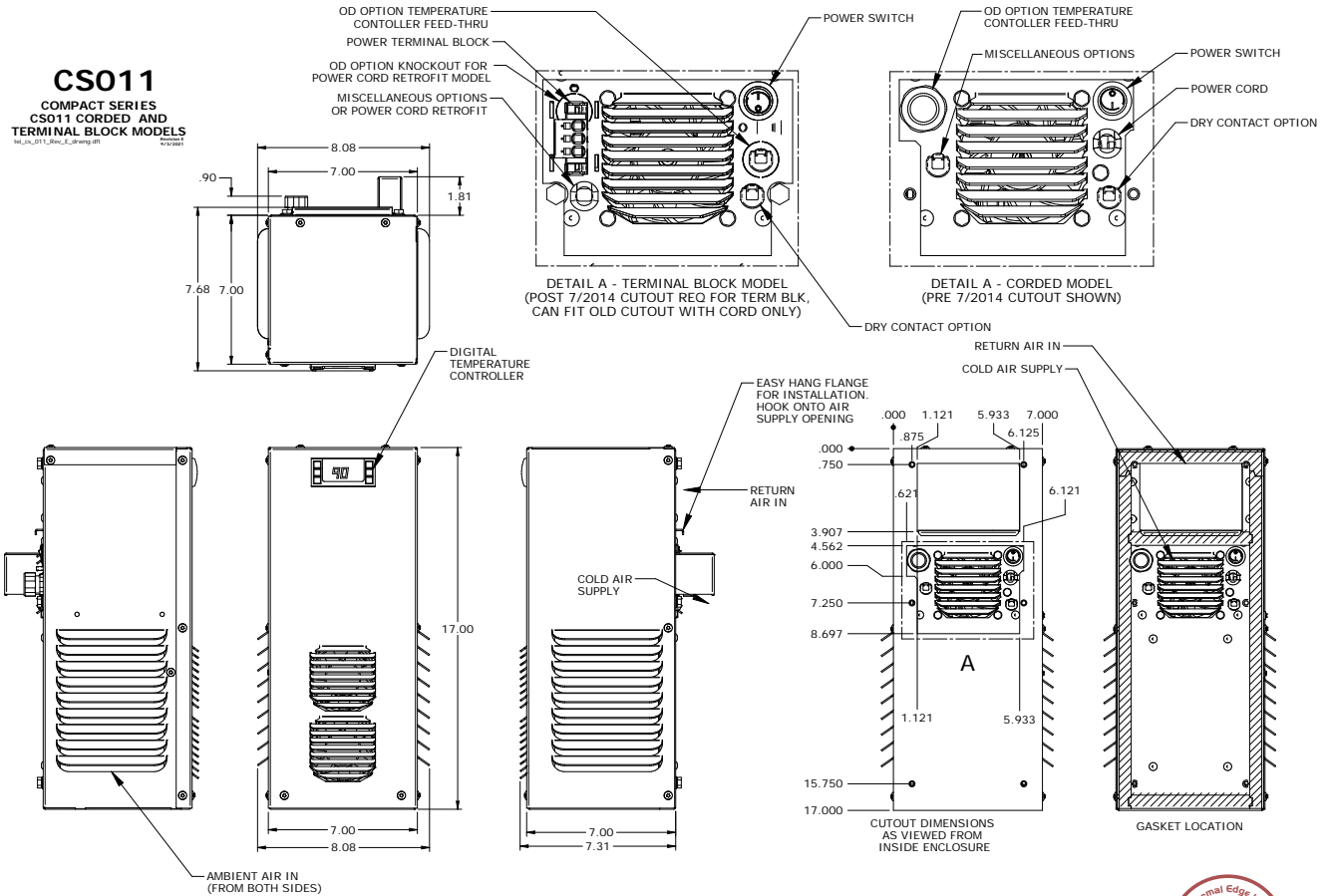
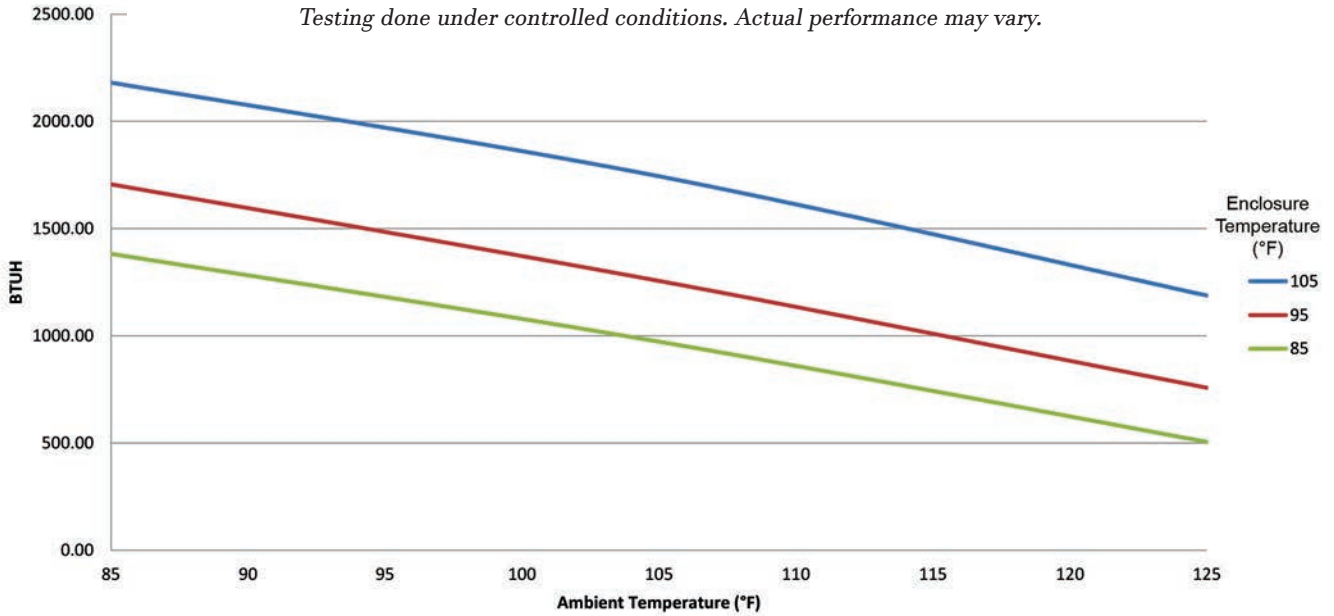

ATTENTION: If ordering a replacement for a Thermal Edge air conditioner, please include the part number and serial number of the unit being replaced in your order. This will ensure that we ship a replacement that is compatible with the cutout dimensions and power connection features of the older model. All information subject to change without notice.



1000 BTUH | INDOOR/OUTDOOR, UL TYPES 12, 4 & 4X AVAILABLE

Engineered & manufactured to endure the most difficult of environments and applications.

Thermal Edge air conditioners will exceed environmental requirements in applications like Steel, Food Processing, Petro-Chemical, Cement, Paper & Pulp and Plastics.

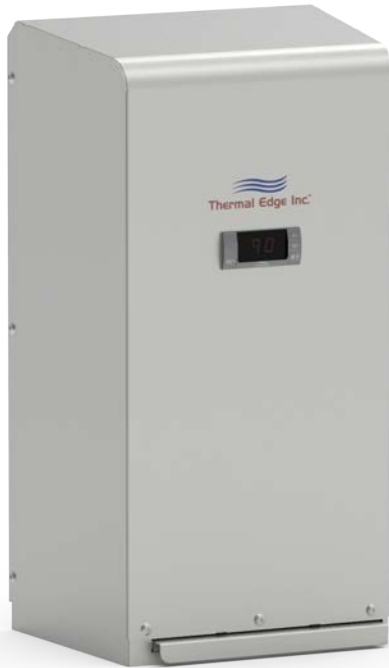

Digital Temperature Controller

- Programmable set point and temperature controls
- Visible Error and/or alarm messaging
- System status indication & keypad lockout function

Active Condensate Evaporation System

- Constant elimination of condensate
- Increases unit efficiency by pre-cooling refrigerant

Key Design Features

- Sloped top to allow for water runoff
- Designed with rigid chassis and seam welded shroud
- Thoughtful interior design for easy maintenance
- Narrow body style fits on 12" enclosure

Unit Efficiency

- Temperature operated condenser fan reduces power inrush and saves energy
- Highly efficient rotary compressor
- Fully insulated & sealed cabinet
- Thermal Expansion Valve to maintain cooling capacity over a broad ambient temperature range

Compressor Protection System

- High & Low refrigerant cutouts with fault indication
- Compressor anti short cycle protection
- Compressor run capacitors reduce power inrush, save energy and increase compressor life

OPTIONS:

- High Ambient
- Remote Controller
- Corrosion Protection
- Remote Control/Monitor
- Controller Programming
- Open Door Kill Switch
- Extended Temp. Probe
- Heater
- Dry Contact
- Custom Finish
- Diagnostics

Model	UL Type	BTU/Hour	Material	Voltage/Phase/Hz.	Running Amps	Max. Amb. Temp.	H x W x D	Weight (lbs.) Unit/Ship
NE01010512	12	1000	Powder coated steel	100/1/50	2.3	125°F	22" x 11.8" x 8.5"	53 / 65
NE01010504	4	1000	Powder coated steel	100/1/50	2.3	125°F	22" x 11.8" x 8.5"	53 / 65
NE0101054X	4X	1000	Stainless steel	100/1/50	2.3	125°F	22" x 11.8" x 8.5"	53 / 65
NE0101054XL4	4X	1000	Mill finish aluminum	100/1/50	2.3	125°F	22" x 11.8" x 8.5"	43 / 55
NE01020512	12	1000	Powder coated steel	200/1/50	1.9	125°F	22" x 11.8" x 8.5"	53 / 67
NE01020504	4	1000	Powder coated steel	200/1/50	1.9	125°F	22" x 11.8" x 8.5"	53 / 67
NE0102054X	4X	1000	Stainless steel	200/1/50	1.9	125°F	22" x 11.8" x 8.5"	53 / 67
NE0102054XL4	4X	1000	Mill finish aluminum	200/1/50	1.9	125°F	22" x 11.8" x 8.5"	43 / 57

NE010 100 V 50 Hz

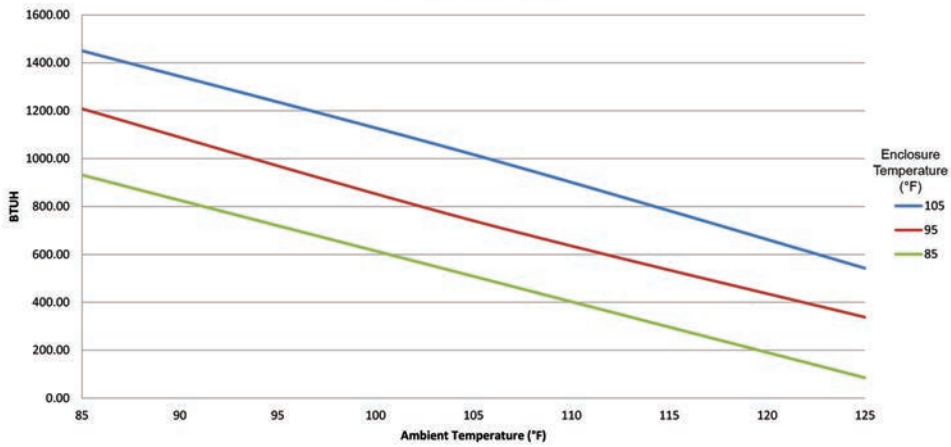

NE010 200 V 50 Hz

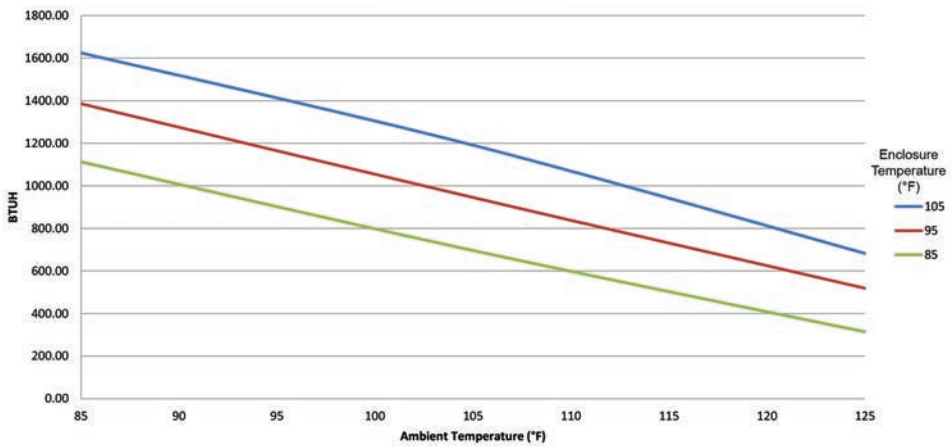

Testing done under controlled conditions. Actual performance may vary.

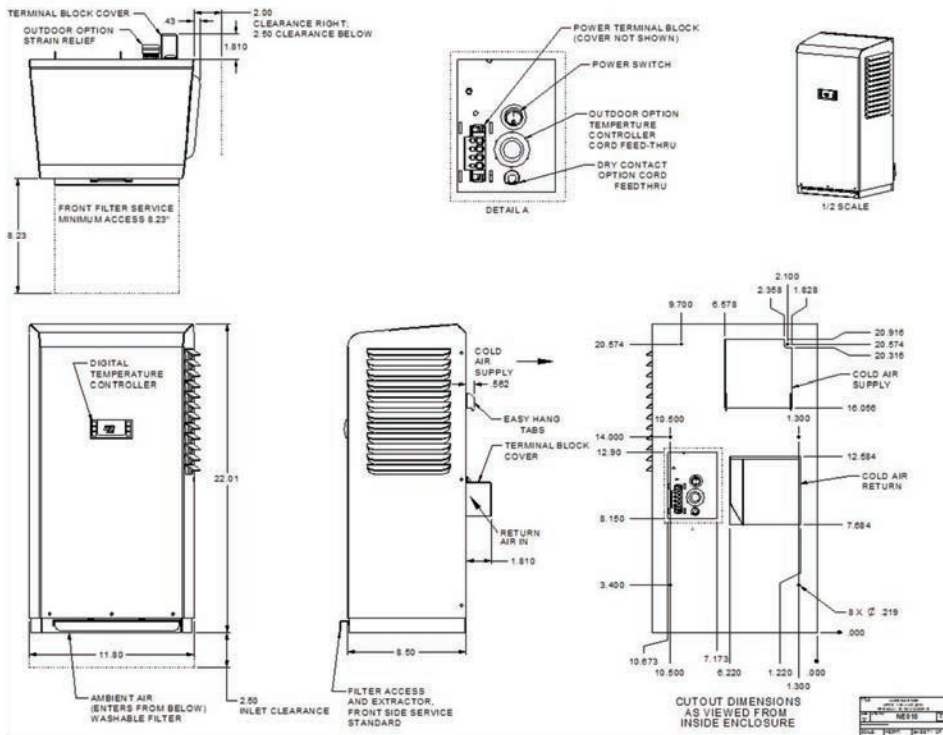

ATTENTION: If ordering a replacement for a Thermal Edge air conditioner, please include the part number and serial number of the unit being replaced in your order. This will ensure that we ship a replacement that is compatible with the cutout dimensions and power connection features of the older model. All information subject to change without notice.

1500 BTUH | INDOOR/OUTDOOR, UL TYPES 12, 4 & 4X AVAILABLE

Engineered & manufactured to endure the most difficult of environments and applications.

Thermal Edge air conditioners will exceed environmental requirements in applications like Steel, Food Processing, Petro-Chemical, Cement, Paper & Pulp and Plastics.

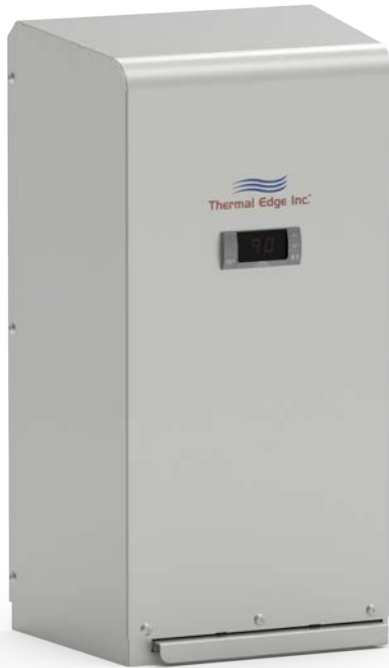

Digital Temperature Controller

- Programmable set point and temperature controls
- Visible Error and/or alarm messaging
- System status indication & keypad lockout function

Active Condensate Evaporation System

- Constant elimination of condensate
- Increases unit efficiency by pre-cooling refrigerant

Key Design Features

- Sloped top to allow for water runoff
- Designed with rigid chassis and seam welded shroud
- Thoughtful interior design for easy maintenance
- Narrow body style fits on 12" enclosure

Unit Efficiency

- Temperature operated condenser fan reduces power inrush and saves energy
- Highly efficient rotary compressor
- Fully insulated & sealed cabinet
- Thermal Expansion Valve to maintain cooling capacity over a broad ambient temperature range

Compressor Protection System

- High & Low refrigerant cutouts with fault indication
- Compressor anti short cycle protection
- Compressor run capacitors reduce power inrush, save energy and increase compressor life

OPTIONS:

- High Ambient
- Remote Controller
- Corrosion Protection
- Remote Control/Monitor
- Controller Programming
- Open Door Kill Switch
- Extended Temp. Probe
- Heater
- Dry Contact
- Custom Finish
- Diagnostics

Model	UL Type	BTU/Hour	Material	Voltage/Phase/Hz.	Running Amps	Max. Amb. Temp.	H x W x D	Weight (lbs.) Unit/Ship
NE01510512	12	1500	Powder coated steel	100/1/50	2.4	125°F	22" x 11.8" x 8.5"	53 / 65
NE01510504	4	1500	Powder coated steel	100/1/50	2.4	125°F	22" x 11.8" x 8.5"	53 / 65
NE0151054X	4X	1500	Stainless steel	100/1/50	2.4	125°F	22" x 11.8" x 8.5"	53 / 65
NE0151054XL4	4X	1500	Mill finish aluminum	100/1/50	2.4	125°F	22" x 11.8" x 8.5"	43 / 55
NE01520512	12	1500	Powder coated steel	200/1/50	1.9	125°F	22" x 11.8" x 8.5"	53 / 67
NE01520504	4	1500	Powder coated steel	200/1/50	1.9	125°F	22" x 11.8" x 8.5"	53 / 67
NE0152054X	4X	1500	Stainless steel	200/1/50	1.9	125°F	22" x 11.8" x 8.5"	53 / 67
NE0152054XL4	4X	1500	Mill finish aluminum	200/1/50	1.9	125°F	22" x 11.8" x 8.5"	43 / 57

NE015 100 V 50 Hz

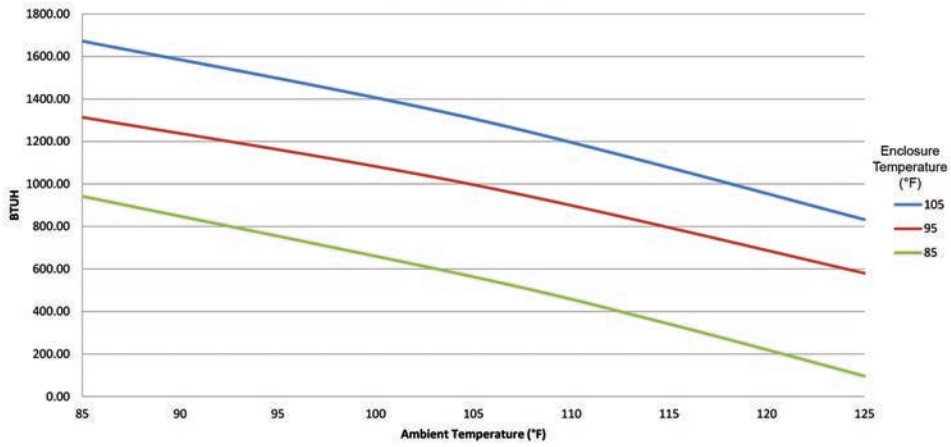

NE015 200 V 50 Hz

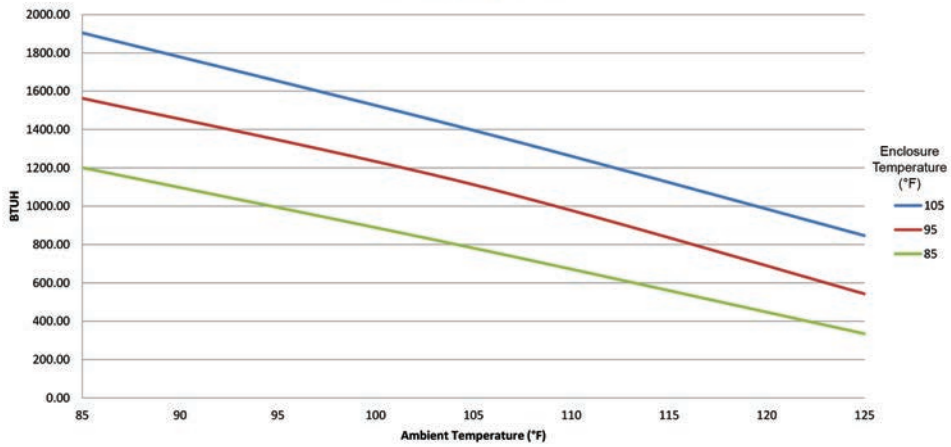

Testing done under controlled conditions. Actual performance may vary.

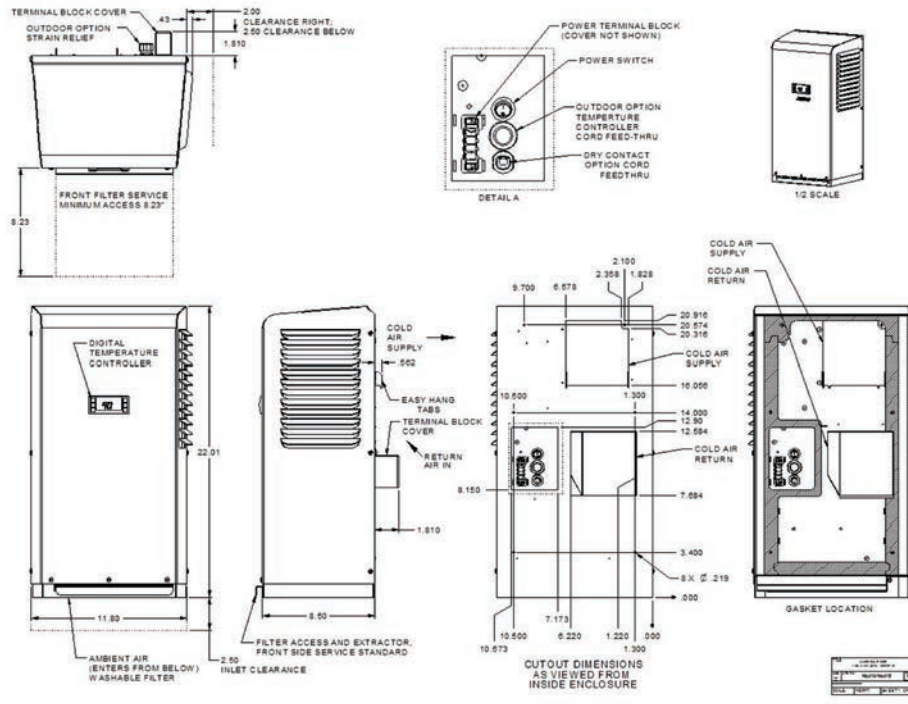

ATTENTION: If ordering a replacement for a Thermal Edge air conditioner, please include the part number and serial number of the unit being replaced in your order. This will ensure that we ship a replacement that is compatible with the cutout dimensions and power connection features of the older model. All information subject to change without notice.

CS020 (50 HZ)

2000 BTUH

INDOOR/OUTDOOR, UL TYPES 12, 4 & 4X AVAILABLE

Engineered & manufactured to endure the most difficult of environments and applications. Thermal Edge air conditioners will exceed environmental requirements in applications like Steel, Food Processing, Petro-Chemical, Cement, Paper & Pulp and Plastics.



Digital Temperature Controller

- Programmable set point and temperature controls
- Visible Error and/or alarm messaging
- System status indication & keypad lockout function

Active Condensate Evaporation System

- Constant elimination of condensate
- Increases unit efficiency by pre-cooling refrigerant

Key Design Features

- Sloped top to allow for water runoff
- Designed with rigid chassis and seam welded shroud
- Thoughtful interior design for easy maintenance
- Narrow body style fits on 10" deep enclosure

Unit Efficiency

- Highly efficient rotary compressor
- Fully insulated & sealed cabinet
- Thermal Expansion Valve to maintain cooling capacity over a broad ambient temperature range

Compressor Protection System

- High & Low refrigerant cutouts with fault indication
- Compressor anti short cycle protection
- Thermal overload protector
- Compressor run capacitors reduce power inrush, save energy and increase compressor life

OPTIONS:

- Low and High Ambient
- Remote Controller
- Corrosion Protection
- Remote Control/Monitor
- Redundant System
- Filter/Filter Frame
- Controller Programming
- Open Door Kill Switch
- Extended Temp. Probe
- Heater
- Dry Contact
- Hazardous Location
- Custom Finish
- Diagnostics

Model	UL Type	BTU/Hour	Material	Voltage/Phase/Hz.	Running Amps	Max. Amb. Temp.	H x W x D	Weight (lbs.) Unit/Ship
CS02023512	12	2000	Powder coated steel	230/1/50	1.7	131°F	20" x 10" x 10"	49 / 63
CS02023504	4	2000	Powder coated steel	230/1/50	1.7	131°F	20" x 10" x 10"	49 / 63
CS0202354X	4X	2000	Stainless steel	230/1/50	1.7	131°F	20" x 10" x 10"	49 / 63
CS0202354XL4	4X	2000	Mill finish aluminum	230/1/50	1.7	131°F	20" x 10" x 10"	39 / 53

Testing done under controlled conditions. Actual performance may vary.

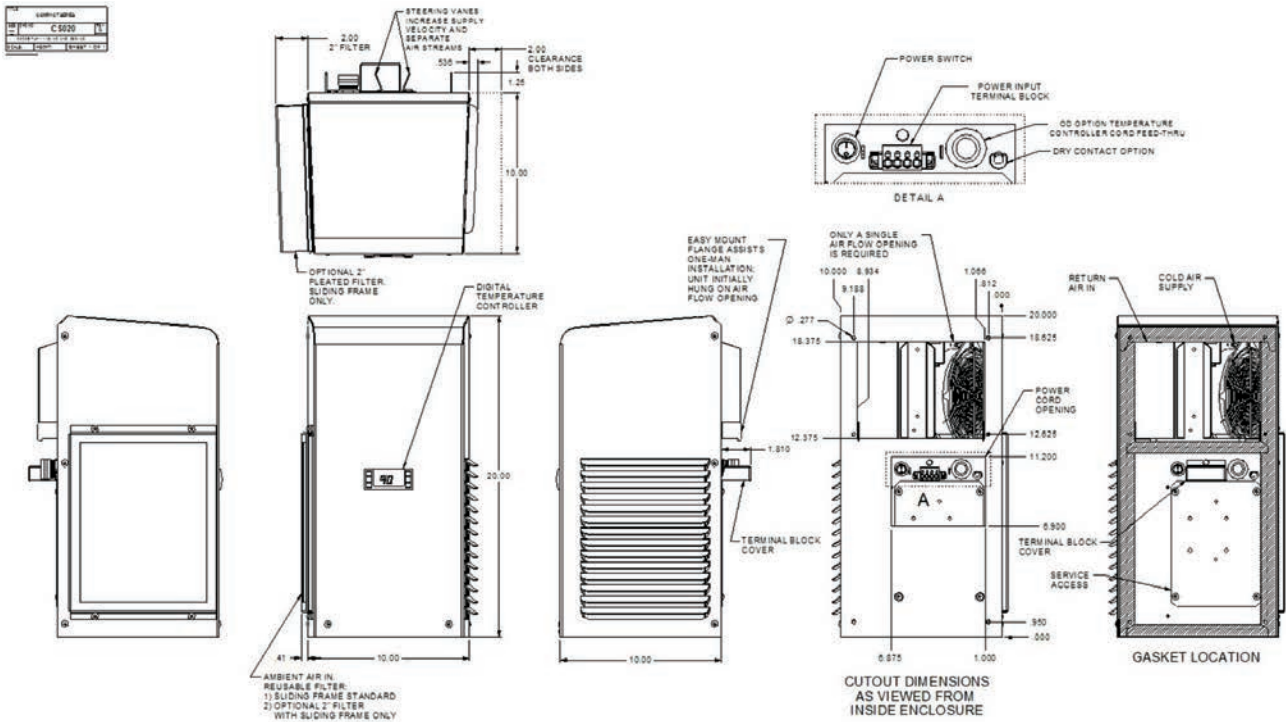
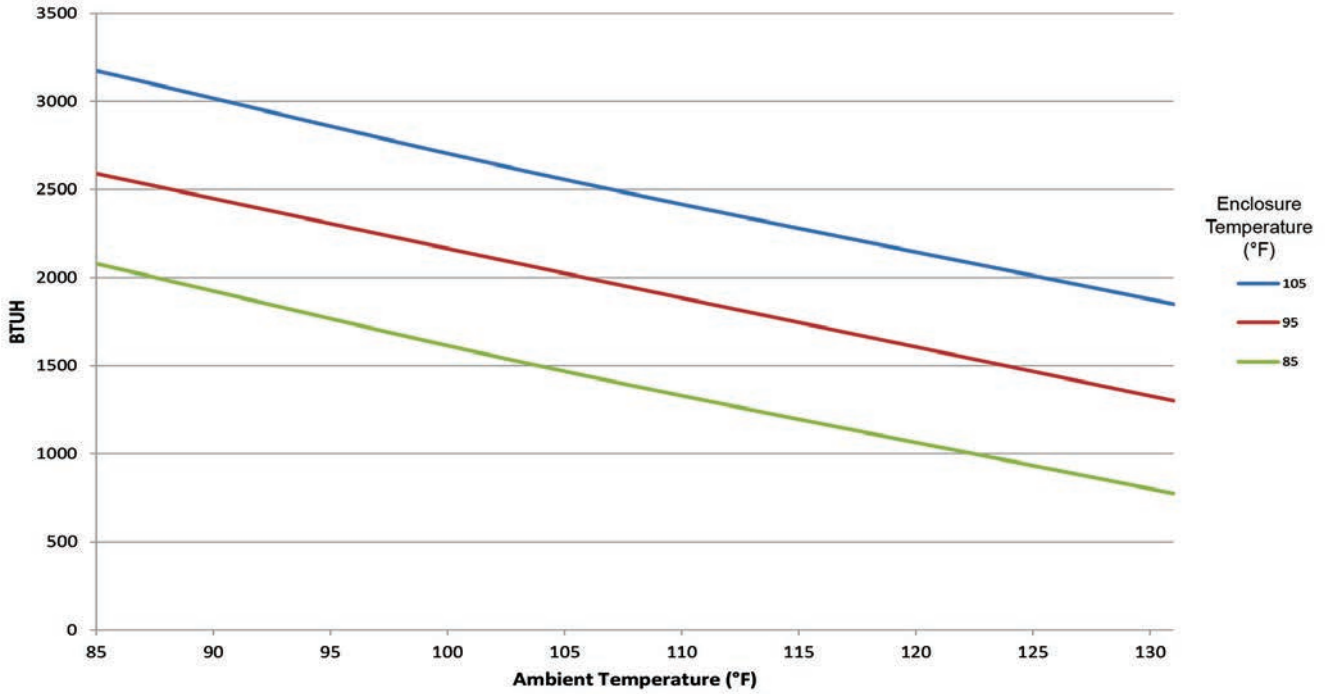

ATTENTION: If ordering a replacement for a Thermal Edge air conditioner, please include the part number and serial number of the unit being replaced in your order. This will ensure that we ship a replacement that is compatible with the cutout dimensions and power connection features of the older model. All information subject to change without notice.



2000 BTUH | INDOOR/OUTDOOR, UL TYPES 12, 4 & 4X AVAILABLE

Engineered & manufactured to endure the most difficult of environments and applications.

Thermal Edge air conditioners will exceed environmental requirements in applications like Steel, Food Processing, Petro-Chemical, Cement, Paper & Pulp and Plastics.



Digital Temperature Controller

- Programmable set point and temperature controls
- Visible Error and/or alarm messaging
- System status indication & keypad lockout function

Active Condensate Evaporation System

- Constant elimination of condensate
- Increases unit efficiency by pre-cooling refrigerant

Key Design Features

- Sloped top to allow for water runoff
- Designed with rigid chassis and seam welded shroud
- Thoughtful interior design for easy maintenance
- Narrow body style fits on 12" enclosure

Unit Efficiency

- Temperature operated condenser fan reduces power inrush and saves energy
- Highly efficient rotary compressor
- Fully insulated & sealed cabinet
- Thermal Expansion Valve to maintain cooling capacity over a broad ambient temperature range

Compressor Protection System

- High & Low refrigerant cutouts with fault indication
- Compressor anti short cycle protection
- Thermal overload protector
- Compressor run capacitors reduce power inrush, save energy and increase compressor life

OPTIONS:

- Low and High Ambient
- Remote Controller
- Corrosion Protection
- Remote Control/Monitor
- Redundant System
- Filter/Filter Frame
- Controller Programming
- Open Door Kill Switch
- Extended Temp. Probe
- Heater
- Dry Contact
- Hazardous Location
- Custom Finish
- Diagnostics
- Vibration Resistant

Model	UL Type	BTU/Hour	Material	Voltage/Phase/Hz.	Running Amps	Max. Amb. Temp.	H x W x D	Weight (lbs.) Unit/Ship
NE02010512	12	2000	Powder coated steel	100/1/50	5.2	125°F	32" x 11.8" x 9.5"	65 / 79
NE02010504	4	2000	Powder coated steel	100/1/50	5.2	125°F	32" x 11.8" x 9.5"	65 / 79
NE0201054X	4X	2000	Stainless steel	100/1/50	5.2	125°F	32" x 11.8" x 9.5"	65 / 79
NE0201054XL4	4X	2000	Mill finish aluminum	100/1/50	5.2	125°F	32" x 11.8" x 9.5"	55 / 64
NE02023512	12	2000	Powder coated steel	230/1/50	1.7	125°F	32" x 11.8" x 9.5"	65 / 86
NE02023504	4	2000	Powder coated steel	230/1/50	1.7	125°F	32" x 11.8" x 9.5"	65 / 86
NE0202354X	4X	2000	Stainless steel	230/1/50	1.7	125°F	32" x 11.8" x 9.5"	65 / 86
NE0202354XL4	4X	2000	Mill finish aluminum	230/1/50	1.7	125°F	32" x 11.8" x 9.5"	55 / 71
NE02038512	12	2000	Powder coated steel	380/1/50	1.4	125°F	38" x 11.8" x 9.5"	99 / 113
NE02038504	4	2000	Powder coated steel	380/1/50	1.4	125°F	38" x 11.8" x 9.5"	99 / 113
NE0203854X	4X	2000	Stainless steel	380/1/50	1.4	125°F	38" x 11.8" x 9.5"	99 / 113
NE0203854XL5	4X	2000	Mill finish aluminum	380/1/50	1.4	125°F	38" x 11.8" x 9.5"	89 / 96

Testing done under controlled conditions. Actual performance may vary.

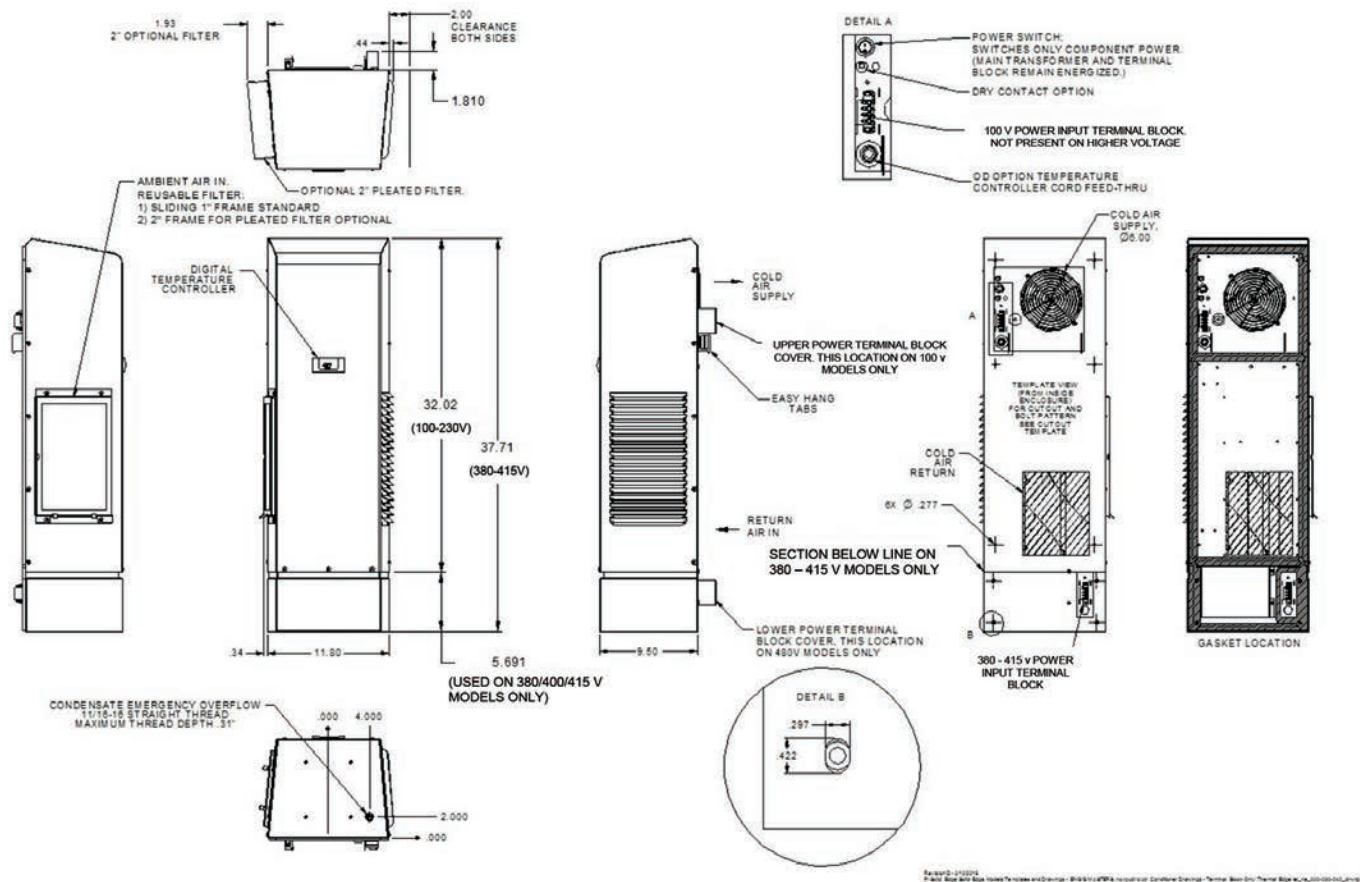
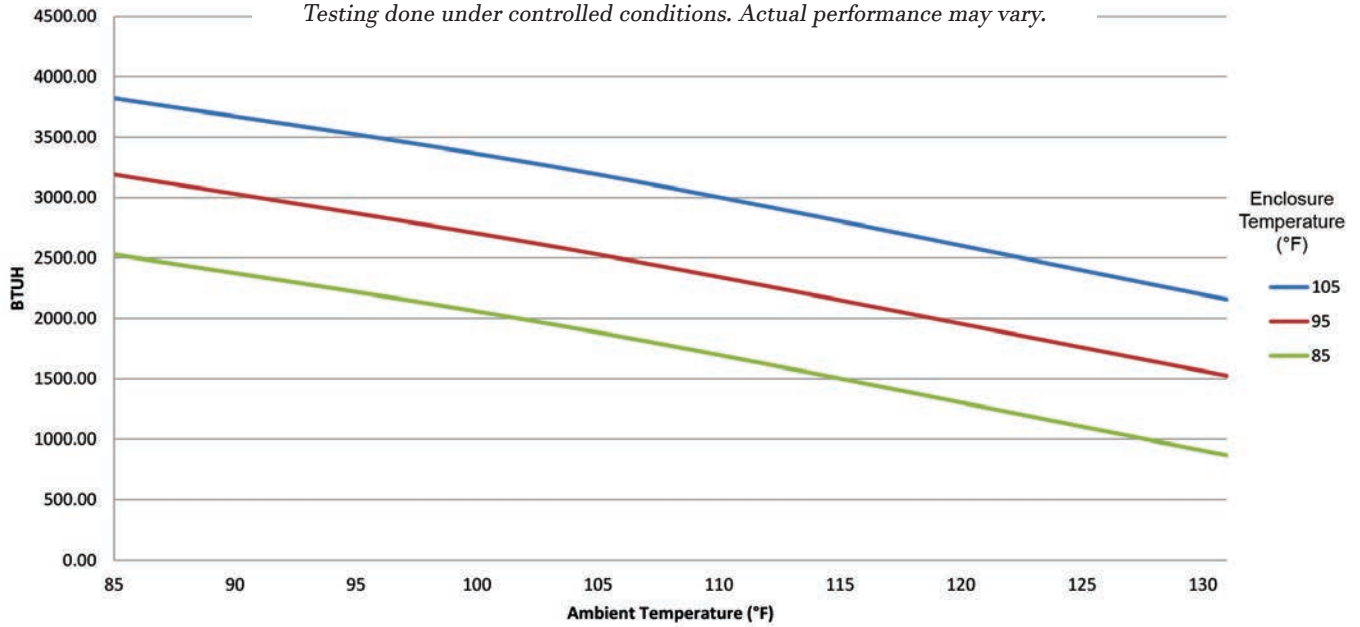

ATTENTION: If ordering a replacement for a Thermal Edge air conditioner, please include the part number and serial number of the unit being replaced in your order. This will ensure that we ship a replacement that is compatible with the cutout dimensions and power connection features of the older model. All information subject to change without notice.



3000 BTUH | INDOOR/OUTDOOR, UL TYPES 12, 4 & 4X AVAILABLE

Engineered & manufactured to endure the most difficult of environments and applications.

Thermal Edge air conditioners will exceed environmental requirements in applications like Steel, Food Processing, Petro-Chemical, Cement, Paper & Pulp and Plastics.



Digital Temperature Controller

- Programmable set point and temperature controls
- Visible Error and/or alarm messaging
- System status indication & keypad lockout function

Active Condensate Evaporation System

- Constant elimination of condensate
- Increases unit efficiency by pre-cooling refrigerant

Key Design Features

- Sloped top to allow for water runoff
- Designed with rigid chassis and seam welded shroud
- Thoughtful interior design for easy maintenance
- Narrow body style fits on 12" enclosure

Unit Efficiency

- Temperature operated condenser fan reduces power inrush and saves energy
- Highly efficient rotary compressor
- Fully insulated & sealed cabinet
- Thermal Expansion Valve to maintain cooling capacity over a broad ambient temperature range

Compressor Protection System

- High & Low refrigerant cutouts with fault indication
- Compressor anti short cycle protection
- Thermal overload protector
- Compressor run capacitors reduce power inrush, save energy and increase compressor life

OPTIONS:

- Low and High Ambient
- Remote Controller
- Corrosion Protection
- Remote Control/Monitor
- Redundant System
- Filter/Filter Frame
- Controller Programming
- Open Door Kill Switch
- Extended Temp. Probe
- Heater
- Dry Contact
- Hazardous Location
- Custom Finish
- Diagnostics
- Vibration Resistant

Model	UL Type	BTU/Hour	Material	Voltage/Phase/Hz.	Running Amps	Max. Amb. Temp.	H x W x D	Weight (lbs.) Unit/Ship
NE03010512	12	3,000	Powder coated steel	100/1/50	5	125°F	32" x 11.8" x 9.5"	66 / 80
NE03010504	4	3,000	Powder coated steel	100/1/50	5	125°F	32" x 11.8" x 9.5"	66 / 80
NE0301054X	4X	3,000	Stainless steel	100/1/50	5	125°F	32" x 11.8" x 9.5"	66 / 80
NE0301054XL4	4X	3,000	Mill finish aluminum	100/1/50	5	125°F	32" x 11.8" x 9.5"	56 / 65
NE03020512	12	3,000	Powder coated steel	200/1/50	3.07	125°F	38" x 11.8" x 9.5"	99 / 113
NE03020504	4	3,000	Powder coated steel	200/1/50	3.07	125°F	38" x 11.8" x 9.5"	99 / 113
NE0302054X	4X	3,000	Stainless steel	200/1/50	3.07	125°F	38" x 11.8" x 9.5"	99 / 113
NE0302054XL4	4X	3,000	Mill finish aluminum	200/1/50	3.07	125°F	38" x 11.8" x 9.5"	89 / 96
NE03038512	12	3,000	Powder coated steel	380/1/50	1.32	125°F	38" x 11.8" x 9.5"	99 / 113
NE03038504	4	3,000	Powder coated steel	380/1/50	1.32	125°F	38" x 11.8" x 9.5"	99 / 113
NE0303854X	4X	3,000	Stainless steel	380/1/50	1.32	125°F	38" x 11.8" x 9.5"	99 / 113
NE0303854XL5	4X	3,000	Mill finish aluminum	380/1/50	1.32	125°F	38" x 11.8" x 9.5"	89 / 96

Testing done under controlled conditions. Actual performance may vary.

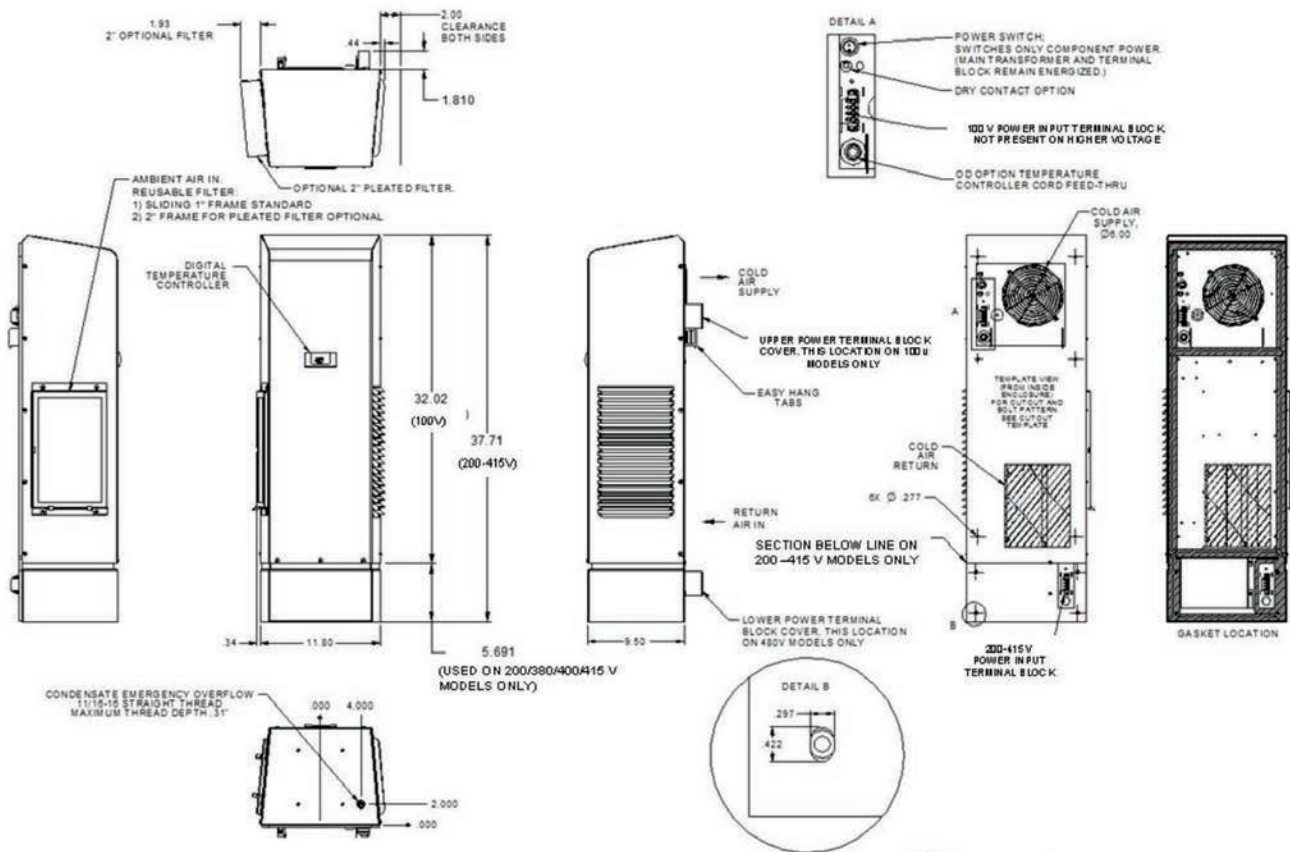
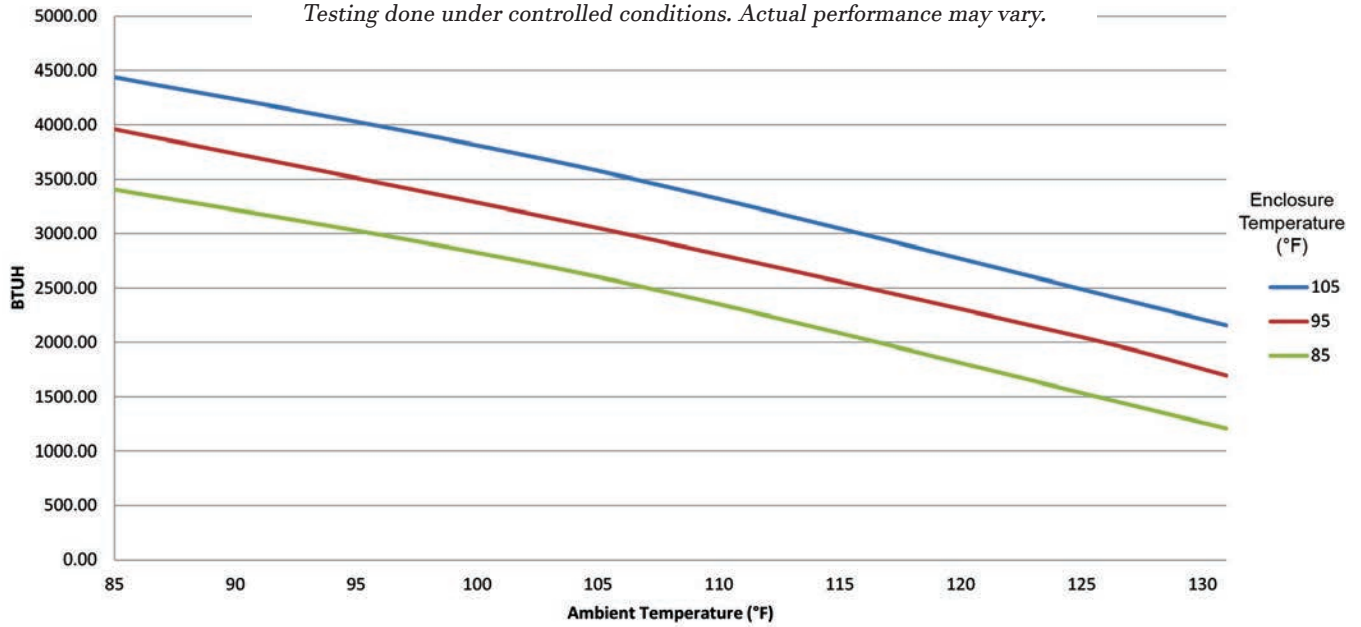

ATTENTION: If ordering a replacement for a Thermal Edge air conditioner, please include the part number and serial number of the unit being replaced in your order. This will ensure that we ship a replacement that is compatible with the cutout dimensions and power connection features of the older model. All information subject to change without notice.



5000 BTUH | INDOOR/OUTDOOR, UL TYPES 12, 4 & 4X AVAILABLE

Engineered & manufactured to endure the most difficult of environments and applications.

Thermal Edge air conditioners will exceed environmental requirements in applications like Steel, Food Processing, Petro-Chemical, Cement, Paper & Pulp and Plastics.



Digital Temperature Controller

- Programmable set point and temperature controls
- Visible Error and/or alarm messaging
- System status indication & keypad lockout function

Active Condensate Evaporation System

- Constant elimination of condensate
- Increases unit efficiency by pre-cooling refrigerant

Key Design Features

- Sloped top to allow for water runoff
- Designed with rigid chassis and seam welded shroud
- Thoughtful interior design for easy maintenance
- Narrow body style fits on 12" enclosure

Unit Efficiency

- Temperature operated condenser fan reduces power inrush and saves energy
- Highly efficient rotary compressor
- Fully insulated & sealed cabinet
- Thermal Expansion Valve to maintain cooling capacity over a broad ambient temperature range

Compressor Protection System

- High & Low refrigerant cutouts with fault indication
- Compressor anti short cycle protection
- Thermal overload protector
- Compressor run capacitors reduce power inrush, save energy and increase compressor life

OPTIONS:

- Low and High Ambient
- Remote Controller
- Corrosion Protection
- Remote Control/Monitor
- Redundant System
- Filter/Filter Frame
- Controller Programming
- Open Door Kill Switch
- Extended Temp. Probe
- Heater
- Dry Contact
- Hazardous Location
- Custom Finish
- Diagnostics
- Vibration Resistant

Model	UL Type	BTU/Hour	Material	Voltage/Phase/Hz.	Running Amps	Max. Amb. Temp.	H x W x D	Weight (lbs.) Unit/Ship
NE05023512	12	5000	Powder coated steel	230/1/50	3.4	131°F	36" x 11.8" x 15.02"	92 / 106
NE05023504	4	5000	Powder coated steel	230/1/50	3.4	131°F	36" x 11.8" x 15.02"	92 / 106
NE0502354X	4X	5000	Stainless steel	230/1/50	3.4	131°F	36" x 11.8" x 15.02"	92 / 106
NE0502354XL4	4X	5000	Mill finish aluminum	230/1/50	3.4	131°F	36" x 11.8" x 15.02"	82 / 86
NE05038512	12	5000	Powder coated steel	380/1/50	2.1	131°F	44.63" x 11.8" x 15.02"	136 / 150
NE05038504	4	5000	Powder coated steel	380/1/50	2.1	131°F	44.63" x 11.8" x 15.02"	136 / 150
NE0503854X	4X	5000	Stainless steel	380/1/50	2.1	131°F	44.63" x 11.8" x 15.02"	136 / 150
NE0503854XL5	4X	5000	Mill finish aluminum	380/1/50	2.1	131°F	44.63" x 11.8" x 15.02"	126 / 140
NE05040512	12	5,000	Powder coated steel	400/1/50	1.9	131°F	44.63" x 11.8" x 15.02"	136 / 150
NE05040504	4	5,000	Powder coated steel	400/1/50	1.9	131°F	44.63" x 11.8" x 15.02"	136 / 150
NE0504054X	4X	5,000	Stainless steel	400/1/50	1.9	131°F	44.63" x 11.8" x 15.02"	136 / 150
NE0504054XL5	4X	5,000	Mill finish aluminum	400/1/50	1.9	131°F	44.63" x 11.8" x 15.02"	126 / 140

Testing done under controlled conditions. Actual performance may vary.

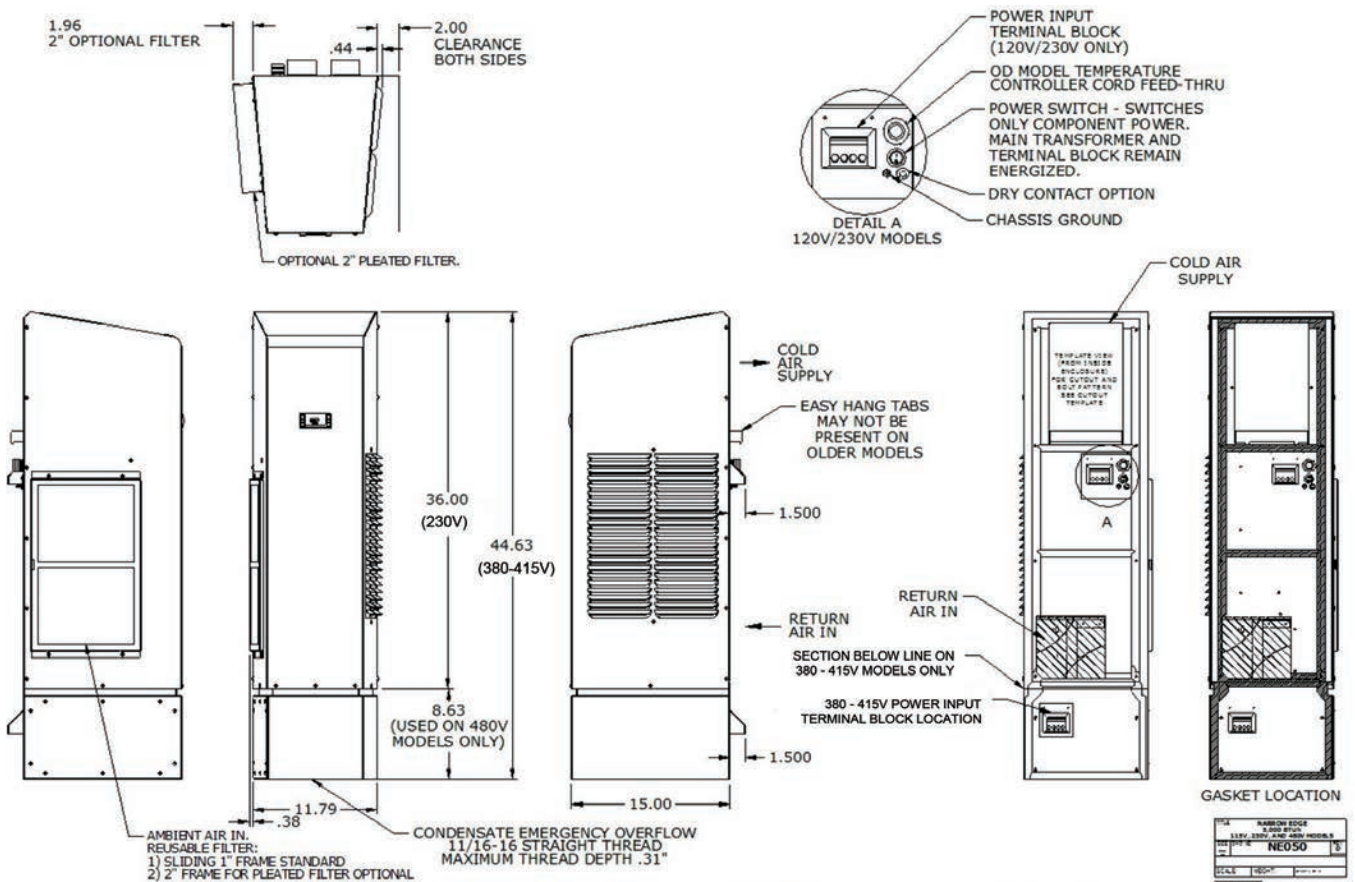
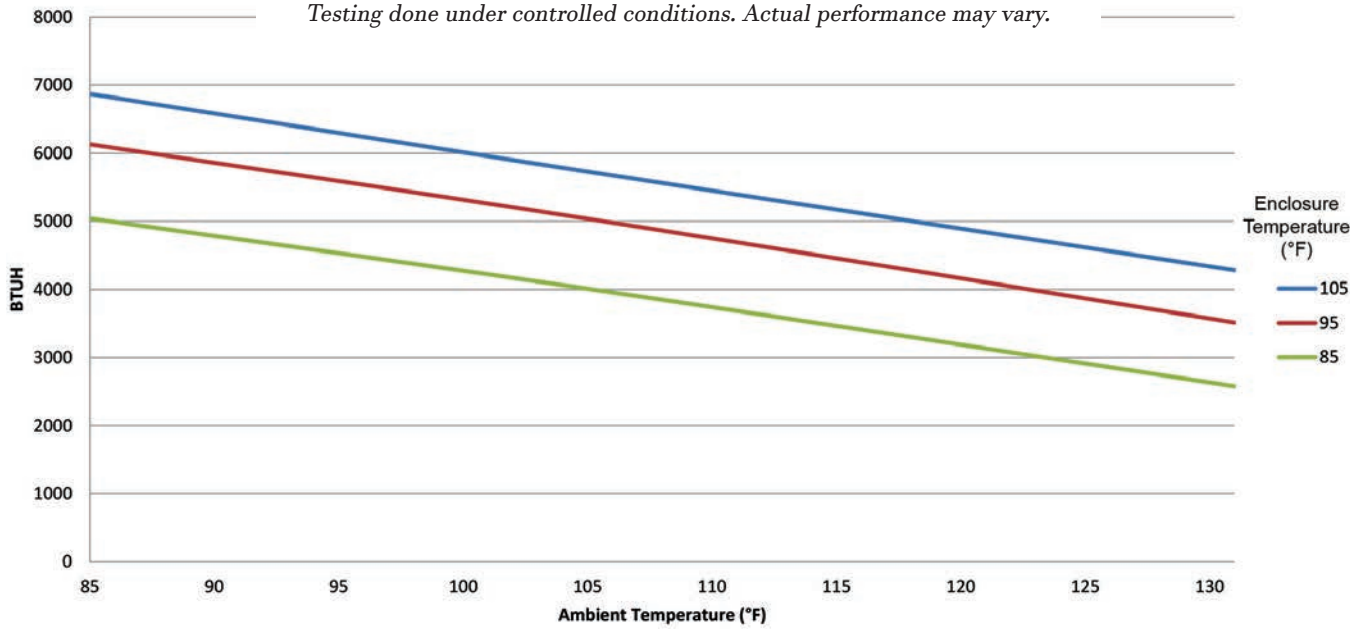

ATTENTION: If ordering a replacement for a Thermal Edge air conditioner, please include the part number and serial number of the unit being replaced in your order. This will ensure that we ship a replacement that is compatible with the cutout dimensions and power connection features of the older model. All information subject to change without notice.



NE050237 (50/60 HZ)

5000 BTUH 230V | INDOOR/OUTDOOR, UL TYPES 12, 4 & 4X AVAILABLE

Engineered & manufactured to endure the most difficult of environments and applications. Thermal Edge air conditioners will exceed environmental requirements in applications like Steel, Food Processing, Petro-Chemical, Cement, Paper & Pulp and Plastics.



Digital Temperature Controller

- Programmable set point and temperature controls
- Visible Error and/or alarm messaging
- System status indication & keypad lockout function

Active Condensate Evaporation System

- Constant elimination of condensate
- Increases unit efficiency by pre-cooling refrigerant

Key Design Features

- Sloped top to allow for water runoff
- Designed with rigid chassis and seam welded shroud
- Thoughtful interior design for easy maintenance
- Narrow body style fits on 12" enclosure

Unit Efficiency

- Temperature operated condenser fan reduces power inrush and saves energy
- Highly efficient rotary compressor
- Fully insulated & sealed cabinet
- Thermal Expansion Valve to maintain cooling capacity over a broad ambient temperature range

Compressor Protection System

- High & Low refrigerant cutouts with fault indication
- Compressor anti short cycle protection
- Thermal overload protector
- Compressor run capacitors reduce power inrush, save energy and increase compressor life

OPTIONS:

- Low and High Ambient
- Remote Controller
- Corrosion Protection
- Remote Control/Monitor
- Redundant System
- Filter/Filter Frame
- Controller Programming
- Open Door Kill Switch
- Extended Temp. Probe
- Heater
- Dry Contact
- Hazardous Location
- Custom Finish
- Diagnostics
- Vibration Resistant

Model	UL Type	BTU/Hour	Material	Voltage/Phase/Hz.	Running Amps	Max. Amb. Temp.	H x W x D	Weight (lbs.) Unit/Ship
NE05023712	12	5000	Powder coated steel	230/1/50 230/1/60	3.1 4.0	131°F	44.36" x 11.8" x 15"	170/ 195
NE05023704	4	5000	Powder coated steel	230/1/50 230/1/60	3.1 4.0	131°F	44.36" x 11.8" x 15"	170/ 195
NE0502374X	4X	5000	Stainless steel	230/1/50 230/1/60	3.1 4.0	131°F	44.36" x 11.8" x 15"	170/ 195
NE0502374XL4	4X	5000	Mill finish aluminum	230/1/50 230/1/60	3.1 4.0	131°F	44.36" x 11.8" x 15"	160/ 185

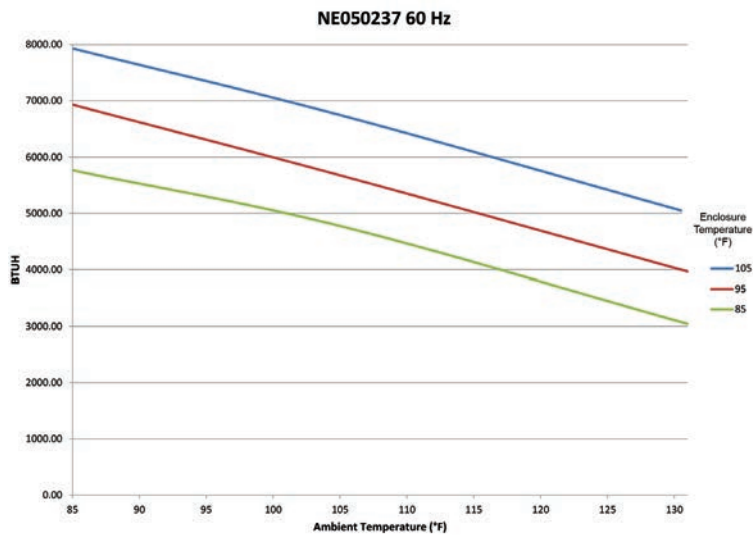
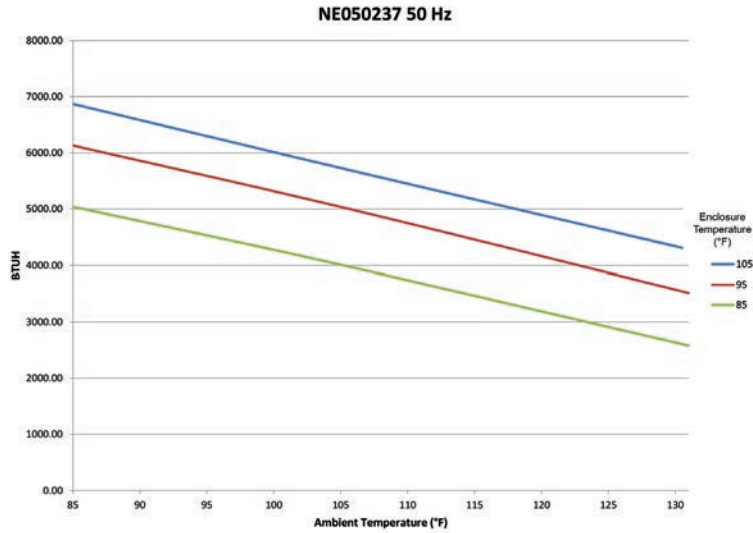

Testing done under controlled conditions. Actual performance may vary.



UL File # SA32252

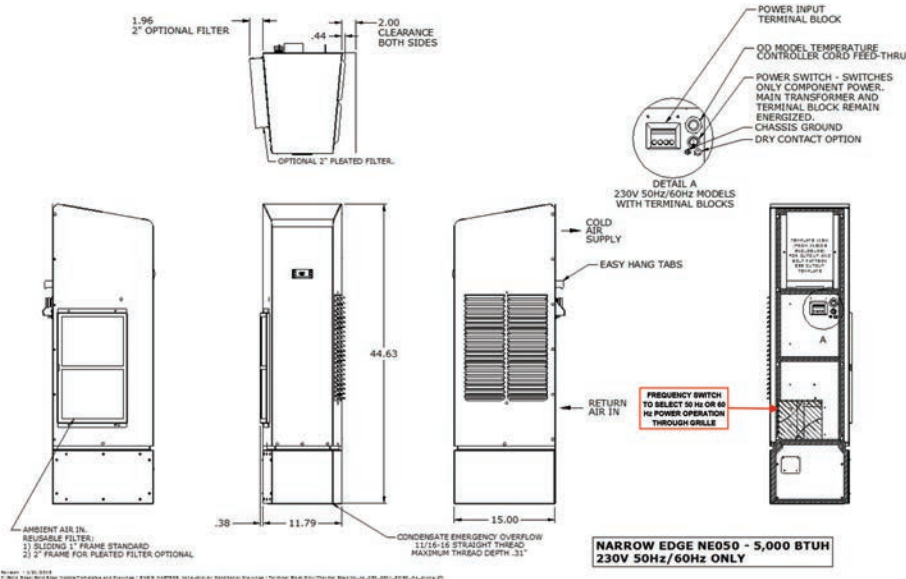

ATTENTION: If ordering a replacement for a Thermal Edge air conditioner, please include the part number and serial number of the unit being replaced in your order. This will ensure that we ship a replacement that is compatible with the cutout dimensions and power connection features of the older model. All information subject to change without notice.

6000 BTUH | INDOOR/OUTDOOR, UL TYPES 12, 4 & 4X AVAILABLE

Engineered & manufactured to endure the most difficult of environments and applications.

Thermal Edge air conditioners will exceed environmental requirements in applications like Steel, Food Processing, Petro-Chemical, Cement, Paper & Pulp and Plastics.



Digital Temperature Controller

- Programmable set point and temperature controls
- Visible Error and/or alarm messaging
- System status indication & keypad lockout function

Active Condensate Evaporation System

- Constant elimination of condensate
- Increases unit efficiency by pre-cooling refrigerant

Key Design Features

- Sloped top to allow for water runoff
- Designed with rigid chassis and seam welded shroud
- Thoughtful interior design for easy maintenance
- Narrow body style fits on 12" enclosure

Unit Efficiency

- Temperature operated condenser fan reduces power inrush and saves energy
- Highly efficient rotary compressor
- Fully insulated & sealed cabinet
- Thermal Expansion Valve to maintain cooling capacity over a broad ambient temperature range

Compressor Protection System

- High & Low refrigerant cutouts with fault indication
- Compressor anti short cycle protection
- Thermal overload protector
- Compressor run capacitors reduce power inrush, save energy and increase compressor life

OPTIONS:

- Low and High Ambient
- Remote Controller
- Corrosion Protection
- Remote Control/Monitor
- Redundant System
- Filter/Filter Frame
- Controller Programming
- Open Door Kill Switch
- Extended Temp. Probe
- Heater
- Dry Contact
- Hazardous Location
- Custom Finish
- Diagnostics
- Vibration Resistant
- Thermal Expansion Valve to maintain cooling capacity over a broad ambient temperature range

Model	UL Type	BTU/Hour	Material	Voltage/Phase/Hz.	Running Amps	Max. Amb. Temp.	H x W x D	Weight (lbs.) Unit/Ship
NE06023512	12	6000	Powder coated steel	230/1/50	3.99	131°F	36" x 11.8" x 15.02"	98 / 112
NE06023504	4	6000	Powder coated steel	230/1/50	3.99	131°F	36" x 11.8" x 15.02"	98 / 112
NE0602354X	4X	6000	Stainless steel	230/1/50	3.99	131°F	36" x 11.8" x 15.02"	98 / 112
NE0602354XL4	4X	6000	Mill finish aluminum	230/1/50	3.99	131°F	36" x 11.8" x 15.02"	88 / 102
NE06038512	12	6000	Powder coated steel	380/1/50	2.4	131°F	44.63" x 11.8" x 15.02"	142 / 156
NE06038504	4	6000	Powder coated steel	380/1/50	2.4	131°F	44.63" x 11.8" x 15.02"	142 / 156
NE0603854X	4X	6000	Stainless steel	380/1/50	2.4	131°F	44.63" x 11.8" x 15.02"	142 / 156
NE0603854XL5	4X	6000	Mill finish aluminum	380/1/50	2.4	131°F	44.63" x 11.8" x 15.02"	117 / 146
NE06040512	12	6,000	Powder coated steel	400/1/50	2.3	131°F	44.63" x 11.8" x 15.02"	142 / 156
NE06040504	4	6,000	Powder coated steel	400/1/50	2.3	131°F	44.63" x 11.8" x 15.02"	142 / 156
NE0604054X	4X	6,000	Stainless steel	400/1/50	2.3	131°F	44.63" x 11.8" x 15.02"	142 / 156
NE0604054XL5	4X	6,000	Mill finish aluminum	400/1/50	2.3	131°F	44.63" x 11.8" x 15.02"	132 / 146

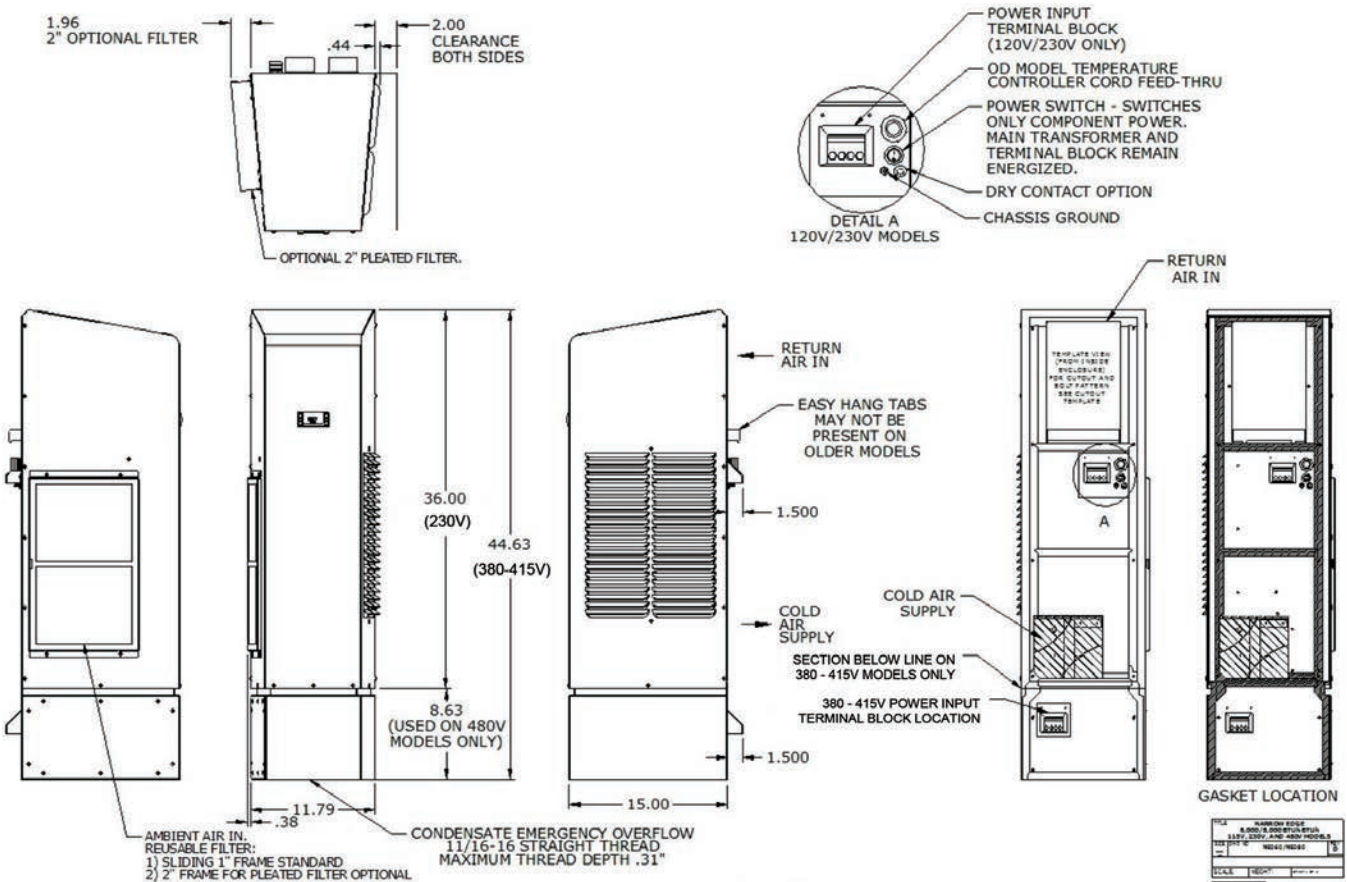
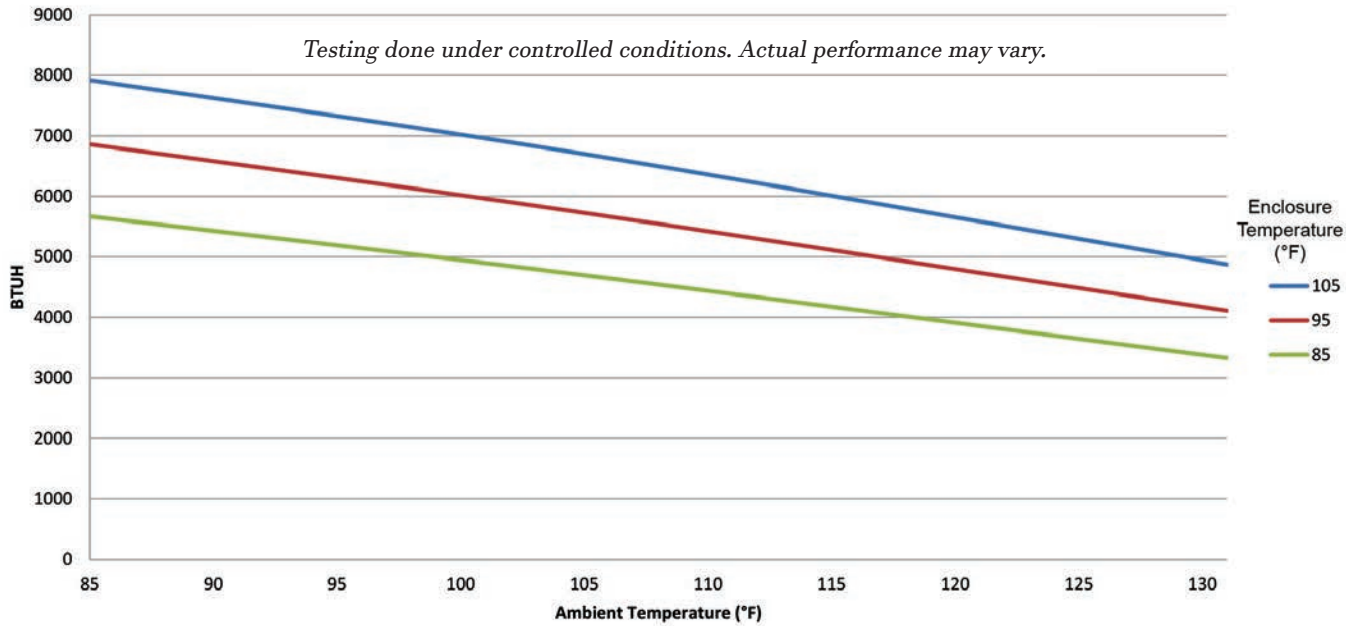

ATTENTION: If ordering a replacement for a Thermal Edge air conditioner, please include the part number and serial number of the unit being replaced in your order. This will ensure that we ship a replacement that is compatible with the cutout dimensions and power connection features of the older model. All information subject to change without notice.



NE060237 (50/60 HZ)

4/18/2024

6000 BTUH 230V

INDOOR/OUTDOOR, UL TYPES 12, 4 & 4X AVAILABLE

Engineered & manufactured to endure the most difficult of environments and applications. Thermal Edge air conditioners will exceed environmental requirements in applications like Steel, Food Processing, Petro-Chemical, Cement, Paper & Pulp and Plastics.



Digital Temperature Controller

- Programmable set point and temperature controls
- Visible Error and/or alarm messaging
- System status indication & keypad lockout function

Active Condensate Evaporation System

- Constant elimination of condensate
- Increases unit efficiency by pre-cooling refrigerant

Key Design Features

- Sloped top to allow for water runoff
- Designed with rigid chassis and seam welded shroud
- Thoughtful interior design for easy maintenance
- Narrow body style fits on 12" enclosure

Unit Efficiency

- Temperature operated condenser fan reduces power inrush and saves energy
- Highly efficient rotary compressor
- Fully insulated & sealed cabinet
- Thermal Expansion Valve to maintain cooling capacity over a broad ambient temperature range

Compressor Protection System

- High & Low refrigerant cutouts with fault indication
- Compressor anti short cycle protection
- Thermal overload protector
- Compressor run capacitors reduce power inrush, save energy and increase compressor life

OPTIONS:

- Low and High Ambient
- Remote Controller
- Corrosion Protection
- Remote Control/Monitor
- Redundant System
- Filter/Filter Frame
- Controller Programming
- Open Door Kill Switch
- Extended Temp. Probe
- Heater
- Dry Contact
- Hazardous Location
- Custom Finish
- Diagnostics
- Vibration Resistant

Model	UL Type	BTU/Hour	Material	Voltage/Phase/Hz.	Running Amps	Max. Amb. Temp.	H x W x D	Weight (lbs.) Unit/Ship
NE06023712	12	6000	Powder coated steel	230/1/50 230/1/60	3.7 4.2	131°F	44.36" x 11.8" x 15"	170 / 195
NE06023704	4	6000	Powder coated steel	230/1/50 230/1/60	3.7 4.2	131°F	44.36" x 11.8" x 15"	170 / 195
NE0602374X	4X	6000	Stainless steel	230/1/5 230/1/60	3.7 4.2	131°F	44.36" x 11.8" x 15"	170 / 195
NE0602374XL4	4X	6000	Mill finish aluminum	230/1/50 230/1/60	3.7 4.2	131°F	44.36" x 11.8" x 15"	160 / 185

Testing done under controlled conditions. Actual performance may vary.

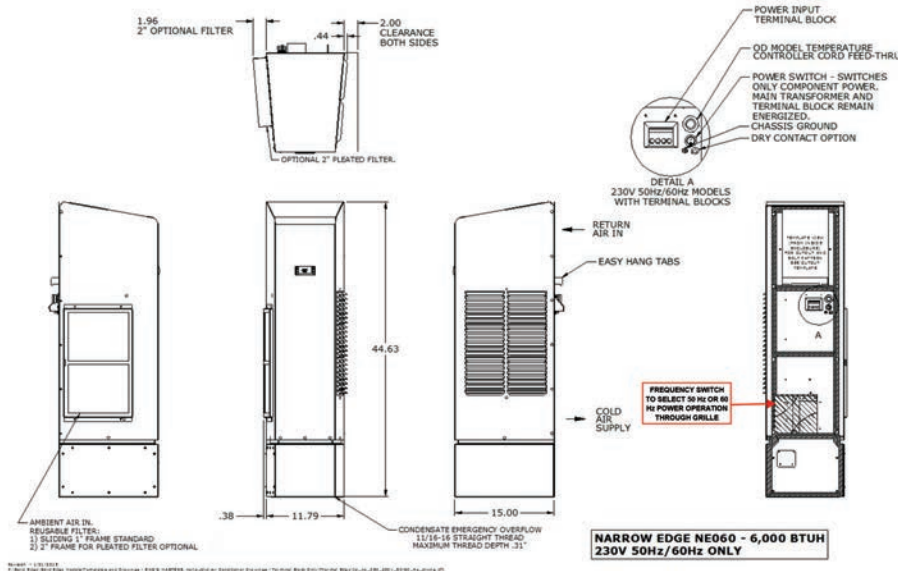
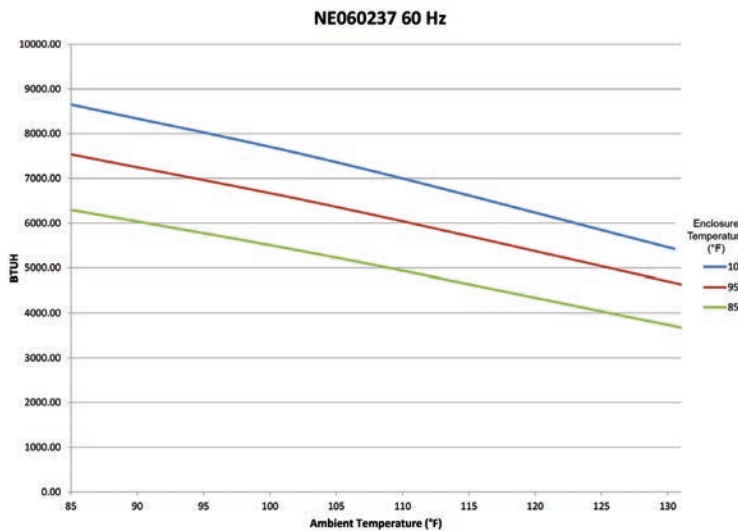
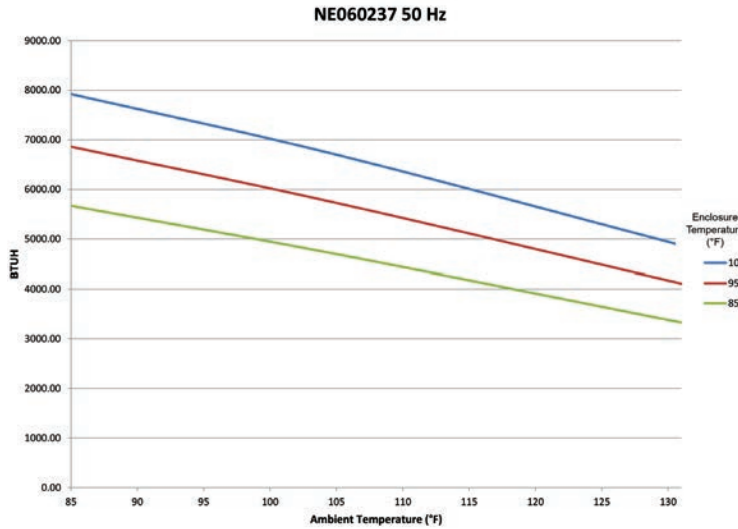

UL File # SA32252



ATTENTION: If ordering a replacement for a Thermal Edge air conditioner, please include the part number and serial number of the unit being replaced in your order. This will ensure that we ship a replacement that is compatible with the cutout dimensions and power connection features of the older model. All information subject to change without notice.

HC080 (50 HZ)

8000 BTUH | INDOOR/OUTDOOR, UL TYPES 12, 4 & 4X AVAILABLE

Engineered & manufactured to endure the most difficult of environments and applications.

Thermal Edge air conditioners will exceed environmental requirements in applications like Steel, Food Processing, Petro-Chemical, Cement, Paper & Pulp and Plastics.



Digital Temperature Controller

- Programmable set point and temperature controls
- Visible Error and/or alarm messaging
- System status indication & keypad lockout function

Active Condensate Evaporation System

- Constant elimination of condensate
- Increases unit efficiency by pre-cooling refrigerant

Key Design Features

- Sloped top to allow for water runoff
- Designed with rigid chassis and seam welded shroud
- Thoughtful interior design for easy maintenance

Unit Efficiency

- Temperature operated condenser fan reduces power inrush and saves energy
- Highly efficient rotary compressor
- Fully insulated & sealed cabinet
- Thermal Expansion Valve to maintain cooling capacity over a broad ambient temperature range

Compressor Protection System

- High & Low refrigerant cutouts with fault indication
- Compressor anti short cycle protection
- Thermal overload protector
- Compressor run capacitors reduce power inrush, save energy and increase compressor life

OPTIONS:

- Low and High Ambient
- Remote Controller
- Corrosion Protection
- Remote Control/Monitor
- Redundant System
- Filter/Filter Frame
- Controller Programming
- Open Door Kill Switch
- Extended Temp. Probe
- Heater
- Dry Contact
- Hazardous Location
- Custom Finish
- Diagnostics
- Hard Start Kit

Model	UL Type	BTU/Hour	Material	Voltage/Phase/Hz.	Running Amps	Max. Amb. Temp.	H x W x D	Weight (lbs.) Unit/Ship
HC08023512	12	8,000	Powder coated steel	230/1/50	7.1	125°F	48" x 15.86" x 15"	166 / 186
HC08023504	4	8,000	Powder coated steel	230/1/50	7.1	125°F	48" x 15.86" x 15"	166 / 186
HC0802354X	4X	8,000	Stainless steel	230/1/50	7.1	125°F	48" x 15.86" x 15"	166 / 186
HC0802354XL4	4X	8,000	Mill finish aluminum	230/1/50	7.1	125°F	48" x 15.86" x 15"	156 / 176
HC08038512	12	8,000	Powder coated steel	380/1/50	4.3	125°F	57.6" x 15.86" x 15"	232 / 275
HC08038504	4	8,000	Powder coated steel	380/1/50	4.3	125°F	57.6" x 15.86" x 15"	232 / 275
HC0803854X	4X	8,000	Stainless steel	380/1/50	4.3	125°F	57.6" x 15.86" x 15"	232 / 275
HC0803854XL5	4X	8,000	Mill finish aluminum	380/1/50	4.3	125°F	57.6" x 15.86" x 15"	222 / 265
HC08040512	12	8,000	Powder coated steel	400/1/50	4.1	125°F	57.6" x 15.86" x 15"	232 / 275
HC08040504	4	8,000	Powder coated steel	400/1/50	4.1	125°F	57.6" x 15.86" x 15"	232 / 275
HC0804054X	4X	8,000	Stainless steel	400/1/50	4.1	125°F	57.6" x 15.86" x 15"	232 / 275
HC0804054XL5	4X	8,000	Mill finish aluminum	400/1/50	4.1	125°F	57.6" x 15.86" x 15"	222 / 265

Testing done under controlled conditions. Actual performance may vary.

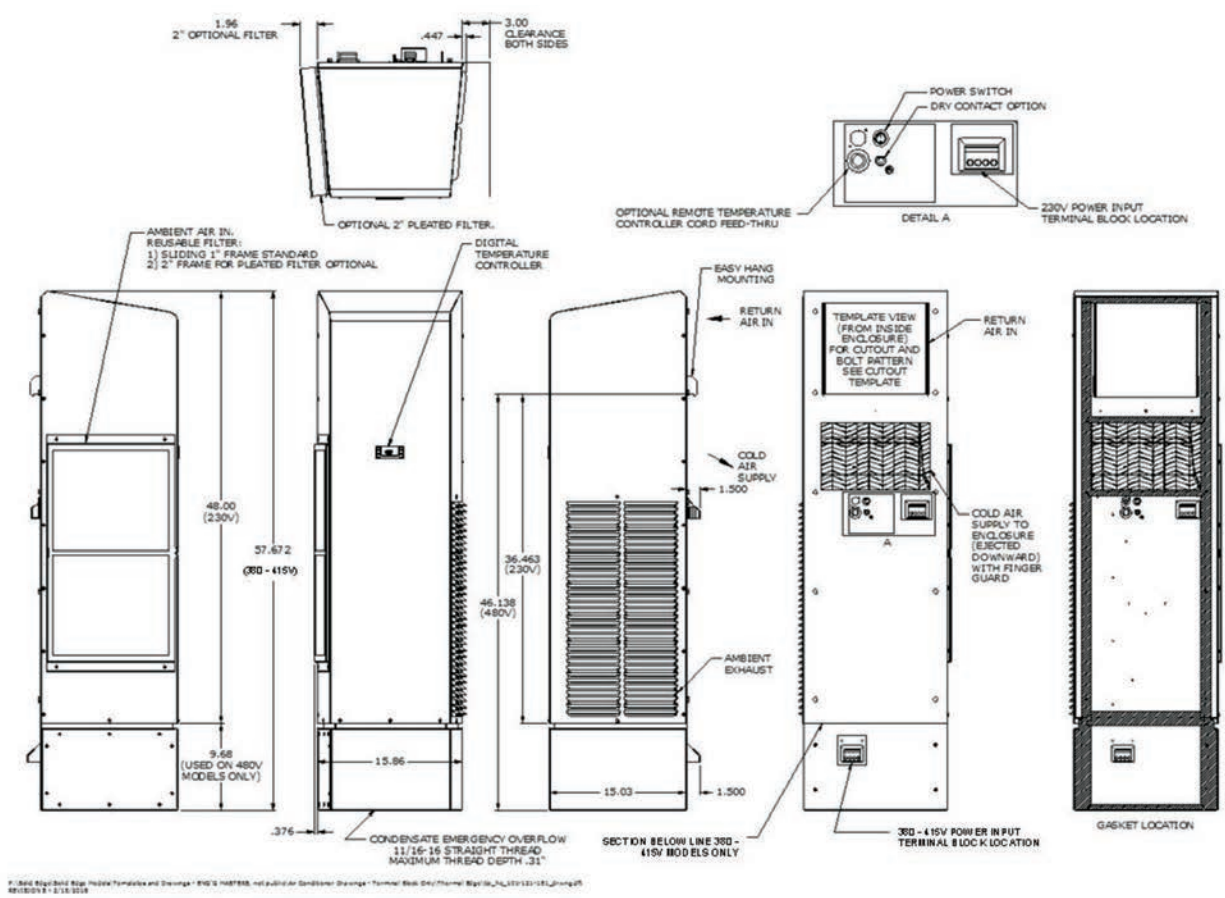
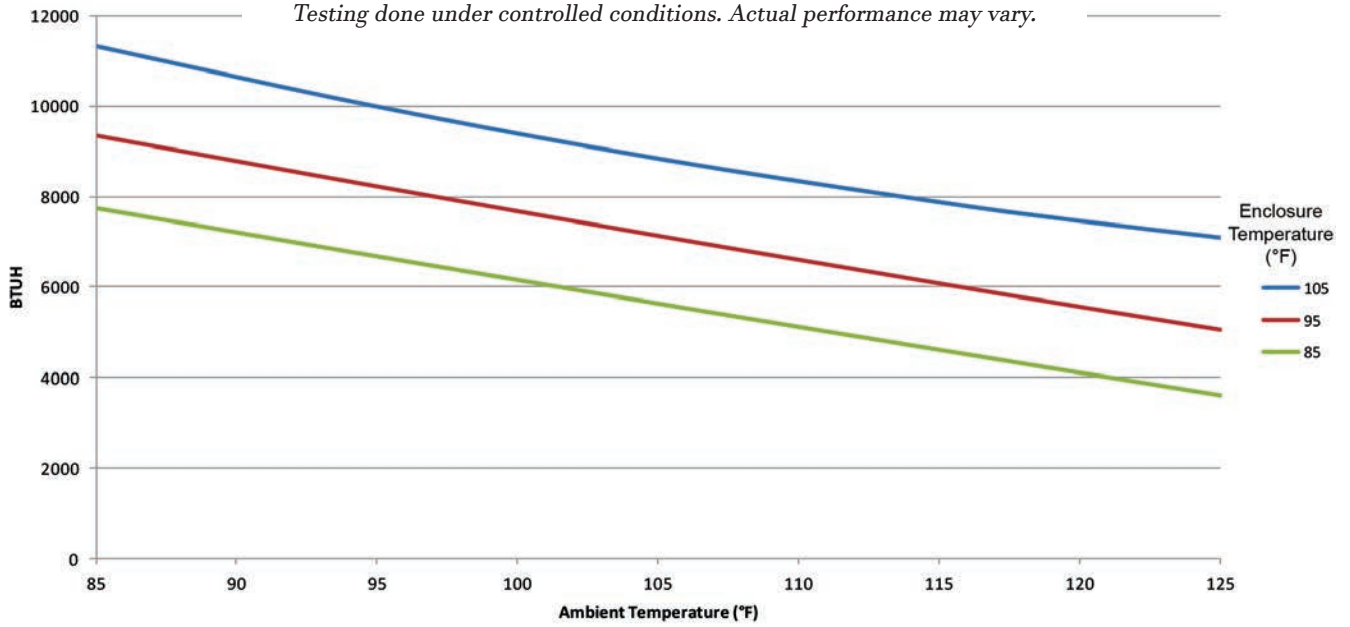

ATTENTION: If ordering a replacement for a Thermal Edge air conditioner, please include the part number and serial number of the unit being replaced in your order. This will ensure that we ship a replacement that is compatible with the cutout dimensions and power connection features of the older model. All information subject to change without notice.



HC101 (50 HZ)

10,000 BTUH | INDOOR/OUTDOOR, UL TYPES 12, 4 & 4X AVAILABLE

Engineered & manufactured to endure the most difficult of environments and applications.

Thermal Edge air conditioners will exceed environmental requirements in applications like Steel, Food Processing, Petro-Chemical, Cement, Paper & Pulp and Plastics.



Digital Temperature Controller

- Programmable set point and temperature controls
- Visible Error and/or alarm messaging
- System status indication & keypad lockout function

Active Condensate Evaporation System

- Constant elimination of condensate
- Increases unit efficiency by pre-cooling refrigerant

Key Design Features

- Sloped top to allow for water runoff
- Designed with rigid chassis and seam welded shroud
- Thoughtful interior design for easy maintenance

Unit Efficiency

- Temperature operated condenser fan reduces power inrush and saves energy
- Highly efficient rotary compressor
- Fully insulated & sealed cabinet
- Thermal Expansion Valve to maintain cooling capacity over a broad ambient temperature range

Compressor Protection System

- High & Low refrigerant cutouts with fault indication
- Compressor anti short cycle protection
- Thermal overload protector
- Compressor run capacitors reduce power inrush, save energy and increase compressor life

OPTIONS:

- Low and High Ambient
- Remote Controller
- Corrosion Protection
- Remote Control/Monitor
- Redundant System
- Filter/Filter Frame
- Controller Programming
- Open Door Kill Switch
- Extended Temp. Probe
- Heater
- Dry Contact
- Hazardous Location
- Custom Finish
- Diagnostics
- Hard Start Kit

Model	UL Type	BTU/Hour	Material	Voltage/Phase/Hz.	Running Amps	Max. Amb. Temp.	H x W x D	Weight (lbs.) Unit/Ship
HC10123512	12	10,000	Powder coated steel	230/1/50	6.4	131°F	48" x 15.86" x 15"	166 / 186
HC10123504	4	10,000	Powder coated steel	230/1/50	6.4	131°F	48" x 15.86" x 15"	166 / 186
HC1012354X	4X	10,000	Stainless steel	230/1/50	6.4	131°F	48" x 15.86" x 15"	166 / 186
HC1012354XL4	4X	10,000	Mill finish aluminum	230/1/50	6.4	131°F	48" x 15.86" x 15"	156 / 176
HC10138512	12	10,000	Powder coated steel	380/1/50	3.9	131°F	57.6" x 15.86" x 15"	232 / 275
HC10138504	4	10,000	Powder coated steel	380/1/50	3.9	131°F	57.6" x 15.86" x 15"	232 / 275
HC1013854X	4X	10,000	Stainless steel	380/1/50	3.9	131°F	57.6" x 15.86" x 15"	232 / 275
HC1013854XL5	4X	10,000	Mill finish aluminum	380/1/50	3.9	131°F	57.6" x 15.86" x 15"	222 / 265
HC10140512	12	10,000	Powder coated steel	400/1/50	3.7	131°F	57.6" x 15.86" x 15"	232 / 275
HC10140504	4	10,000	Powder coated steel	400/1/50	3.7	131°F	57.6" x 15.86" x 15"	232 / 275
HC1014054X	4X	10,000	Stainless steel	400/1/50	3.7	131°F	57.6" x 15.86" x 15"	232 / 275
HC1014054XL5	4X	10,000	Mill finish aluminum	400/1/50	3.7	131°F	57.6" x 15.86" x 15"	222 / 265

HC121 (50 HZ)

12,000 BTUH | INDOOR/OUTDOOR, UL TYPES 12, 4 & 4X AVAILABLE

Engineered & manufactured to endure the most difficult of environments and applications.

Thermal Edge air conditioners will exceed environmental requirements in applications like Steel, Food Processing, Petro-Chemical, Cement, Paper & Pulp and Plastics.



Digital Temperature Controller

- Programmable set point and temperature controls
- Visible Error and/or alarm messaging
- System status indication & keypad lockout function

Active Condensate Evaporation System

- Constant elimination of condensate
- Increases unit efficiency by pre-cooling refrigerant

Key Design Features

- Sloped top to allow for water runoff
- Designed with rigid chassis and seam welded shroud
- Thoughtful interior design for easy maintenance

Unit Efficiency

- Temperature operated condenser fan reduces power inrush and saves energy
- Highly efficient rotary compressor
- Fully insulated & sealed cabinet
- Thermal Expansion Valve to maintain cooling capacity over a broad ambient temperature range

Compressor Protection System

- High & Low refrigerant cutouts with fault indication
- Compressor anti short cycle protection
- Thermal overload protector
- Compressor run capacitors reduce power inrush, save energy and increase compressor life

OPTIONS:

- Low and High Ambient
- Remote Controller
- Corrosion Protection
- Remote Control/Monitor
- Redundant System
- Filter/Filter Frame
- Controller Programming
- Open Door Kill Switch
- Extended Temp. Probe
- Heater
- Dry Contact
- Hazardous Location
- Custom Finish
- Diagnostics
- Hard Start Kit

Model	UL Type	BTU/Hour	Material	Voltage/Phase/Hz.	Running Amps	Max. Amb. Temp.	H x W x D	Weight (lbs.) Unit/Ship
HC12123512	12	12,000	Powder coated steel	230/1/50	8.6	131°F	48" x 15.86" x 15"	163 / 183
HC12123504	4	12,000	Powder coated steel	230/1/50	8.6	131°F	48" x 15.86" x 15"	163 / 183
HC1212354X	4X	12,000	Stainless steel	230/1/50	8.6	131°F	48" x 15.86" x 15"	163 / 183
HC1212354XL4	4X	12,000	Mill finish aluminum	230/1/50	8.6	131°F	48" x 15.86" x 15"	153 / 173
HC12138512	12	12,000	Powder coated steel	380/1/50	5.2	131°F	57.6" x 15.86" x 15"	237 / 280
HC12138504	4	12,000	Powder coated steel	380/1/50	5.2	131°F	57.6" x 15.86" x 15"	237 / 280
HC1213854X	4X	12,000	Stainless steel	380/1/50	5.2	131°F	57.6" x 15.86" x 15"	237 / 280
HC1213854XL5	4X	12,000	Mill finish aluminum	380/1/50	5.2	131°F	57.6" x 15.86" x 15"	227 / 270
HC12140512	12	12,000	Powder coated steel	400/1/50	4.9	131°F	57.6" x 15.86" x 15"	237 / 280
HC12140504	4	12,000	Powder coated steel	400/1/50	4.9	131°F	57.6" x 15.86" x 15"	237 / 280
HC1214054X	4X	12,000	Stainless steel	400/1/50	4.9	131°F	57.6" x 15.86" x 15"	237 / 280
HC1214054XL5	4X	12,000	Mill finish aluminum	400/1/50	4.9	131°F	57.6" x 15.86" x 15"	227 / 270

Testing done under controlled conditions. Actual performance may vary.

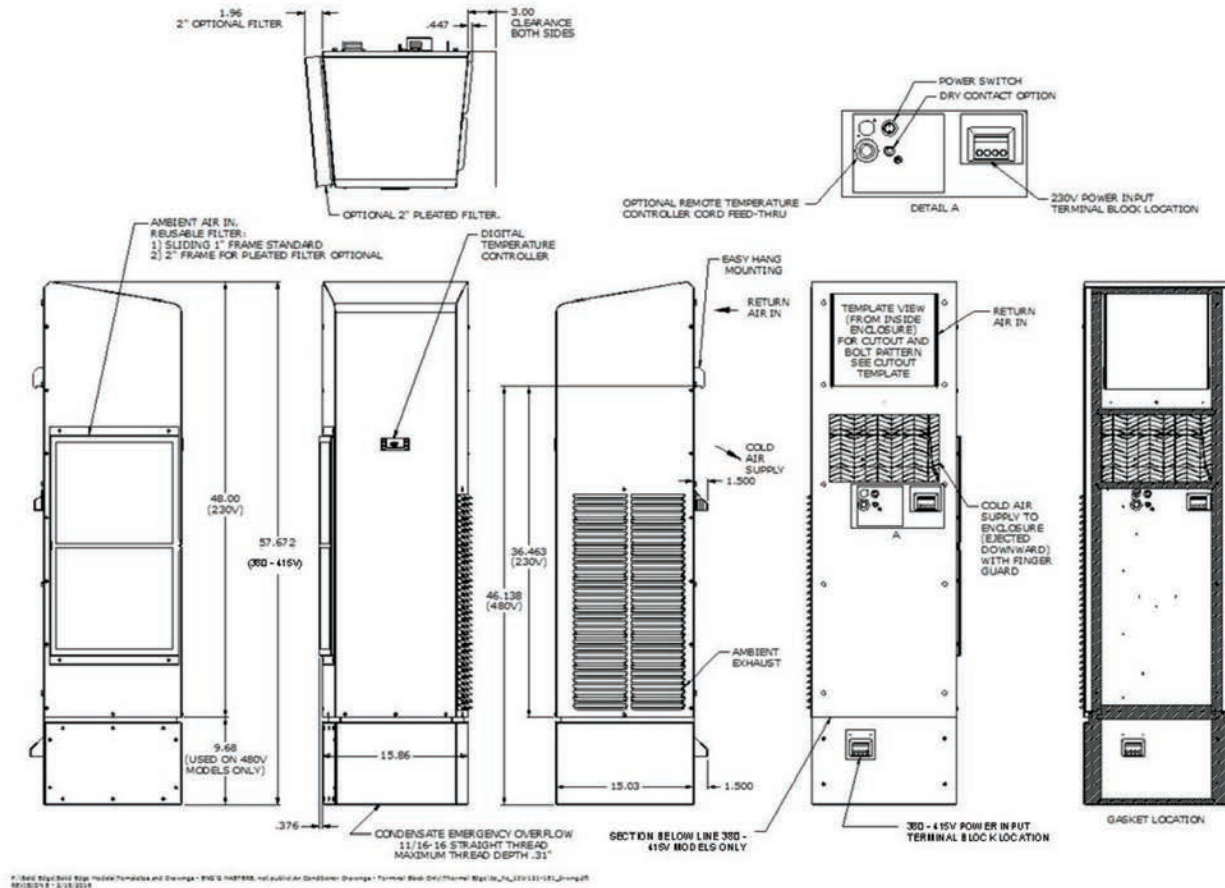
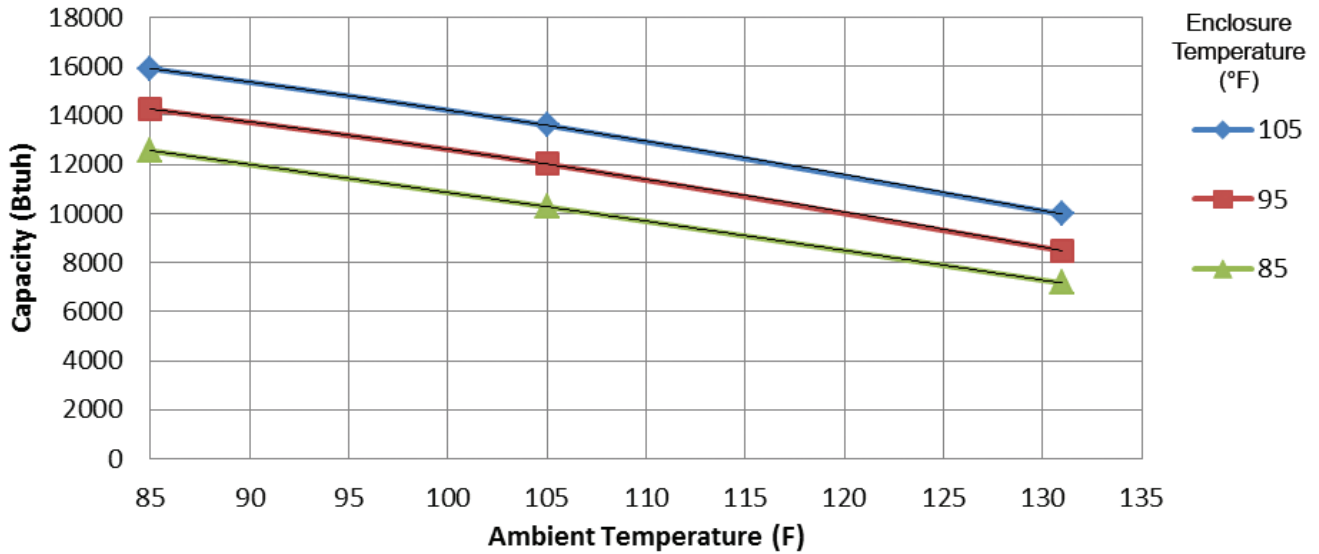

ATTENTION: If ordering a replacement for a Thermal Edge air conditioner, please include the part number and serial number of the unit being replaced in your order. This will ensure that we ship a replacement that is compatible with the cutout dimensions and power connection features of the older model. All information subject to change without notice.



4/18/2024



Thermal Edge Inc.TM

TEMPERATURE CONTROL SOLUTIONS FOR ELECTRICAL ENCLOSURES

60 HZ HAZARDOUS LOCATIONS ENCLOSURE AIR CONDITIONERS

Fully Integrated Condensate Evaporation Package

Programmable Digital Controller

Thermal Expansion Valve

Narrow Design To Fit Onto A 12" Enclosure

Energy Efficient - Low Running Amps



MADE IN AMERICA MATTERS...



HAZARDOUS LOCATION ENCLOSURE AIR CONDITIONING SYSTEMS (J4)

Thermal Edge Hazardous Location air conditioners are in conformance with all requirements of ANSI/NFPA 70, NEC and CAN/CSA-C22.1, Part I for Class I, Division 2, Groups A, B, C, and D.



SYSTEM FEATURES:

- For purged and non-purged enclosures
- Active, energy efficient, Condensate Evaporation System
- Fully programmable digital controller with built-in alarms and alerts
- Remote controller option places controller inside enclosure
- Thermal Expansion Valve for maximum efficiency when temperature or heat load changes
- Hermetically-sealed compressor, thermal overload protector
- Models range from 2,000 to 20,000 BTUH
- Available in UL types 12, 4 and 4X
- Top Mount and Side Mount*

*Critical components in the NRTL Hazardous Location Listing Report must not be substituted with alternate components. Thermal Edge, Inc. and MET Labs must be notified before changes to any drawings, samples, or required documentation will be approved.

Model	BTU/ Hour	Voltage/ Phase/Hz.	Max. Ambient Temp.	Temp. Code
CS020236J4	2000	230/1/60	118°F	T6
NE020126J4	2000	115/1/60	122°F	T4
NE020236J4	2000	230/1/60	122°F	T4
NE020486J4	2000	460/1/60	122°F	T4
NE02S486J4	2000	460/1/60	122°F	T4
NE030126J4	3000	115/1/60	122°F	T4
NE030236J4	3000	230/1/60	122°F	T4
NE030486J4	3000	460/1/60	122°F	T4
NE03S486J4	3000	460/1/60	122°F	T4
NE040126J4	4000	115/1/60	122°F	T4
NE040236J4	4000	230/1/60	122°F	T4
NE040486J4	4000	460/1/60	122°F	T4
NE04S486J4	4000	460/1/60	122°F	T4
NE050126J4	5000	115/1/60	122°F	T4
NE050236J4	5000	230/1/60	122°F	T4
NE050486J4	5000	460/1/60	122°F	T4
NE060126J4	6000	115/1/60	122°F	T4
NE060236J4	6000	230/1/60	122°F	T4
NE060486J4	6000	460/1/60	122°F	T4
TM061126J4	6000	115/1/60	122°F	T4
TM061236J4	6000	230/1/60	122°F	T4
TM061486J4	6000	460/1/60	122°F	T4
NE080126J4	8000	115/1/60	122°F	T4
NE080236J4	8000	230/1/60	122°F	T4
NE080486J4	8000	460/1/60	122°F	T4
TM081126J4	8000	115/1/60	122°F	T4
TM081236J4	8000	230/1/60	122°F	T4
TM081486J4	8000	460/1/60	122°F	T4
HC101126J4	10,000	115/1/60	122°F	T4
HC101236J4	10,000	230/1/60	122°F	T4
HC101486J4	10,000	460/1/60	122°F	T4
HC121126J4	12,000	115/1/60	122°F	T4
HC121236J4	12,000	230/1/60	122°F	T4
HC121486J4	12,000	460/1/60	122°F	T4
HC20C236J4	20,000	230/1/60	122°F	T4
HC20C486J4	20,000	460/1/60	122°F	T4



HAZARDOUS LOCATIONS

2000 BTUH | INDOOR/OUTDOOR, UL TYPES 12, 4 & 4X AVAILABLE

Designed to provide nonincendive cooling for electrical enclosures in hazardous locations, these closed-loop units are ideal for use on systems in chemical and petrochemical, refining, onshore and offshore drilling applications.



OPTIONS:

- Corrosion Protection
- Low Ambient
- Remote Controller
- Dry Contact
- Controller Programming
- External Heater Control
(for Haz Loc enclosure heaters)
- Filter/Filter Frame
- Extended Temp. Probe
- Custom Finish

Thermal Edge CS020 Hazardous Location air conditioners are certified to the following standard(s): *

- ANSI/ISA-12.12.01-2015 Nonincendive Electrical Equipment for use in Class I, Division 2, Groups A, B, C, D Hazardous (Classified) Locations
- CAN/CSA C22.2 No. 213-15 Nonincendive Electrical Equipment for use in Class I, Division 2, Groups A, B, C, D Hazardous (Classified) Locations
- $0^{\circ}\text{C} \leq T_a \leq +48^{\circ}\text{C}$

System Features

- For purged and non-purged enclosures
- Active, energy efficient, Condensate Evaporation System
- Fully programmable digital controller with built in alarms and alerts
- Remote controller option places controller inside enclosure
- Thermal Expansion Valve for maximum efficiency when temperature or heat load changes
- Hermetically sealed compressor thermal overload protector
- 2000 BTUH
- Narrow body style fits on 10" enclosure
- Available in UL types 12, 4 and 4X

Unit Efficiency

- Highly efficient Rotary Compressor
- Fully insulated & sealed cabinet

Model	UL Type	BTU/Hour	Material	Voltage/Phase/Hz.	Running Amps	Max. Amb. Temp.	H x W x D	Unit Weight (lbs.)
CS02012612J4	12	2,000	Powder coated steel	115/1/60	4.1	118°F	20" x 10" x 10"	44
CS02012604J4	4	2,000	Powder coated steel	115/1/60	4.1	118°F	20" x 10" x 10"	44
CS0201264XJ4	4X	2,000	Stainless steel	115/1/60	4.1	118°F	20" x 10" x 10"	44
CS02023612J4	12	2,000	Powder coated steel	230/1/60	2	118°F	20" x 10" x 10"	49
CS02023604J4	4	2,000	Powder coated steel	230/1/60	2	118°F	20" x 10" x 10"	49
CS0202364XJ4	4X	2,000	Stainless steel	230/1/60	2	118°F	20" x 10" x 10"	49

Testing done under controlled conditions. Actual performance may vary.

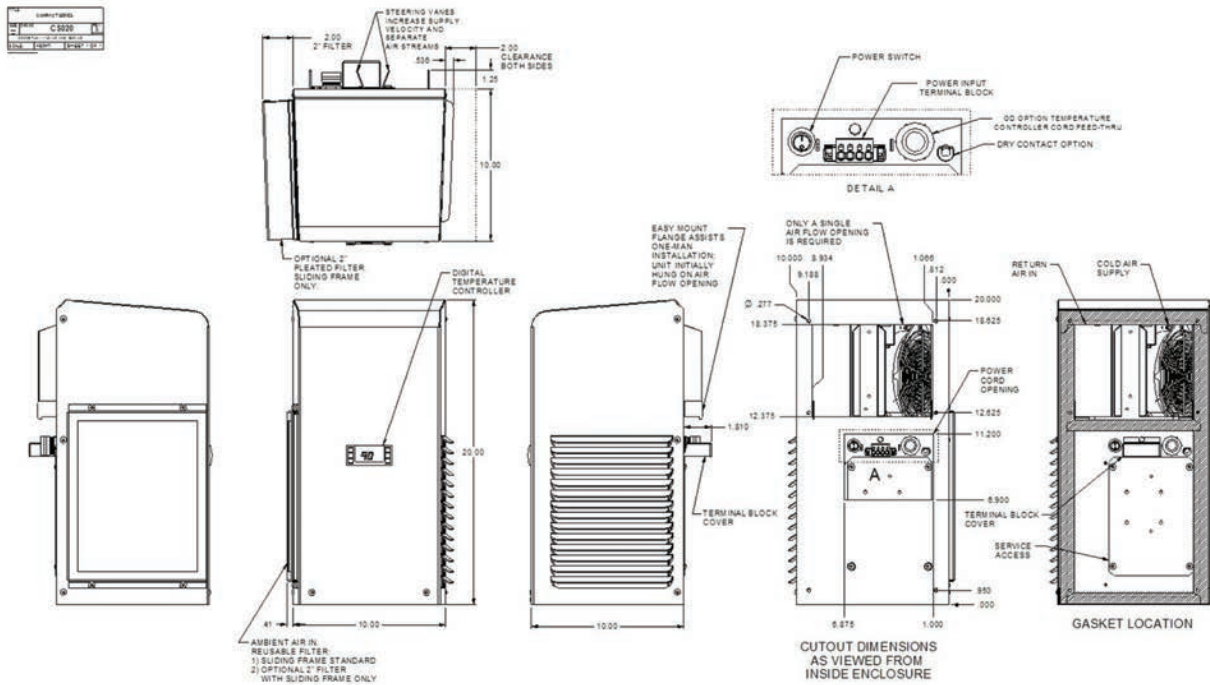
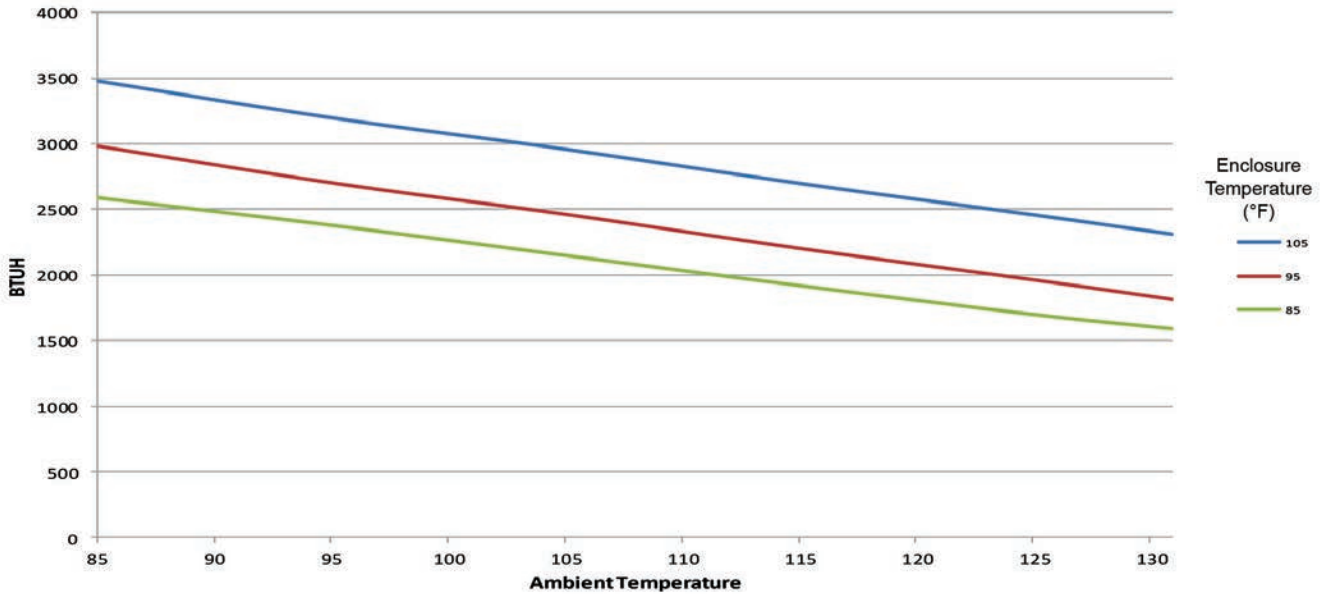

*Critical components in the NRTL Hazardous Location Listing Report must not be substituted with alternate components. Thermal Edge, Inc. and MET Labs must be notified before changes to any drawings, samples, or required documentation are approved.

ATTENTION: If ordering a replacement for a Thermal Edge air conditioner, please include the part number and serial number of the unit being replaced in your order. This will ensure that we ship a replacement that is compatible with the cutout dimensions and power connection features of the older model. All information subject to change without notice.

HAZARDOUS LOCATIONS

2000 BTUH | INDOOR/OUTDOOR, UL TYPES 12, 4 & 4X AVAILABLE

Designed to provide nonincendive cooling for electrical enclosures in hazardous locations, these closed-loop units are ideal for use on systems in chemical and petrochemical, refining, onshore and offshore drilling applications.



OPTIONS:

- Corrosion Protection
- Low Ambient
- Remote Controller
- Dry Contact
- Controller Programming
- External Heater Control
(for Haz Loc enclosure heaters)
- Filter/Filter Frame
- Extended Temp. Probe
- Vibration Resistant
- Custom Finish

Thermal Edge NE020 air conditioners for Hazardous Locations are certified to the following standard(s):*

- ANSI/ISA-12.12.01-2015 Nonincendive Electrical Equipment for use in Class I, Division 2, Groups A, B, C, and D T4 Hazardous (Classified) Locations
- CAN/CSA C22.2 No. 213-15 Nonincendive Electrical Equipment for use in Class I, Division 2, Groups A, B, C, and D T4 Hazardous (Classified) Locations
- 0°C ≤ Ta ≤ +50°C

System Features

- For purged and non-purged enclosures
- Active, energy efficient, Condensate Evaporation System
- Fully programmable digital controller with built in alarms and alerts
- Remote controller option places controller inside enclosure
- Thermal Expansion Valve for maximum efficiency when temperature or heat load changes
- Hermetically sealed compressor thermal overload protector
- 2000 BTUH
- Narrow body style fits on 12" enclosure
- Available in UL types 12, 4 and 4X

Unit Efficiency

- Pressure-operated condenser fan reduces power inrush and saves energy
- Highly efficient Rotary Compressor
- Fully insulated & sealed cabinet

Model	UL Type	BTU/Hour	Material	Voltage/Phase/Hz.	Running Amps	Max. Amb. Temp.	H x W x D	Unit Weight (lbs.)
NE02012612J4	12	2000	Powder coated steel	115/1/60	3.2	122°F	32" x 11.8" x 9.5"	60
NE02012604J4	4	2000	Powder coated steel	115/1/60	3.2	122°F	32" x 11.8" x 9.5"	60
NE0201264XJ4	4X	2000	Stainless steel	115/1/60	3.2	122°F	32" x 11.8" x 9.5"	60
NE02023612J4	12	2000	Powder coated steel	230/1/60	3.07	122°F	32" x 11.8" x 9.5"	72
NE02023604J4	4	2000	Powder coated steel	230/1/60	3.07	122°F	32" x 11.8" x 9.5"	72
NE0202364XJ4	4X	2000	Stainless steel	230/1/60	3.07	122°F	32" x 11.8" x 9.5"	72
NE02048612J4	12	2000	Powder coated steel	460/1/60	0.84	122°F	38" x 11.8" x 9.5"	94
NE02048604J4	4	2000	Powder coated steel	460/1/60	0.84	122°F	38" x 11.8" x 9.5"	94
NE0204864XJ4	4X	2000	Stainless steel	460/1/60	0.84	122°F	38" x 11.8" x 9.5"	94

Testing done under controlled conditions. Actual performance may vary.

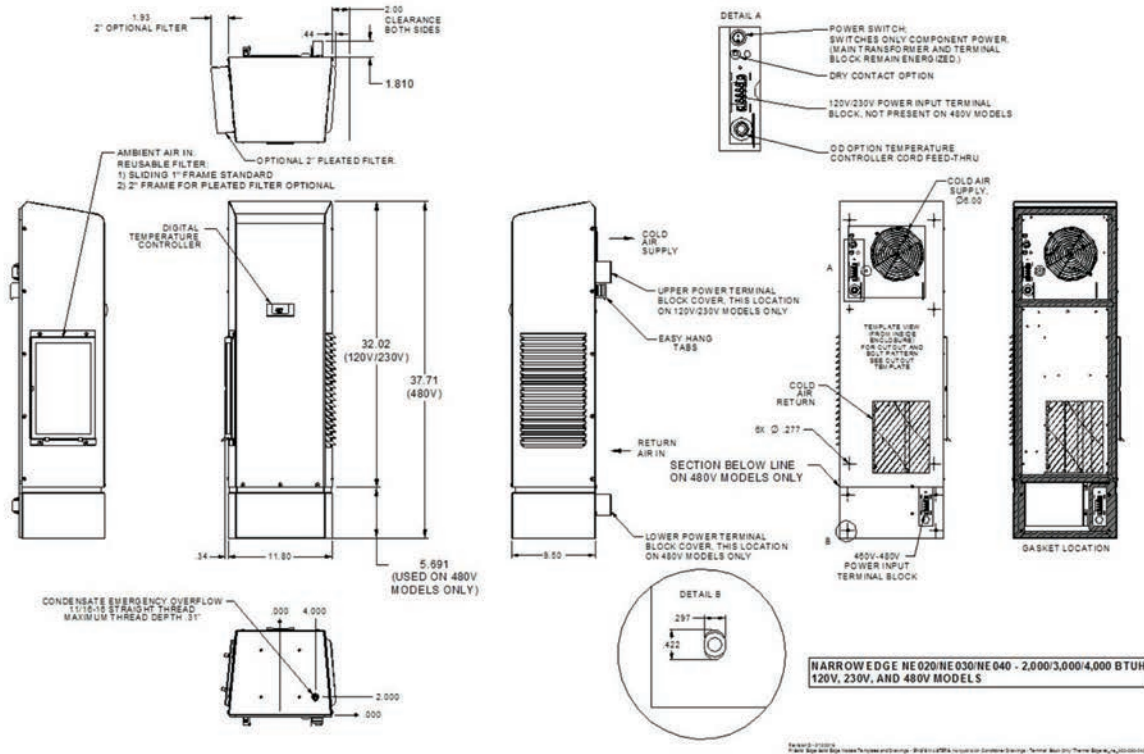
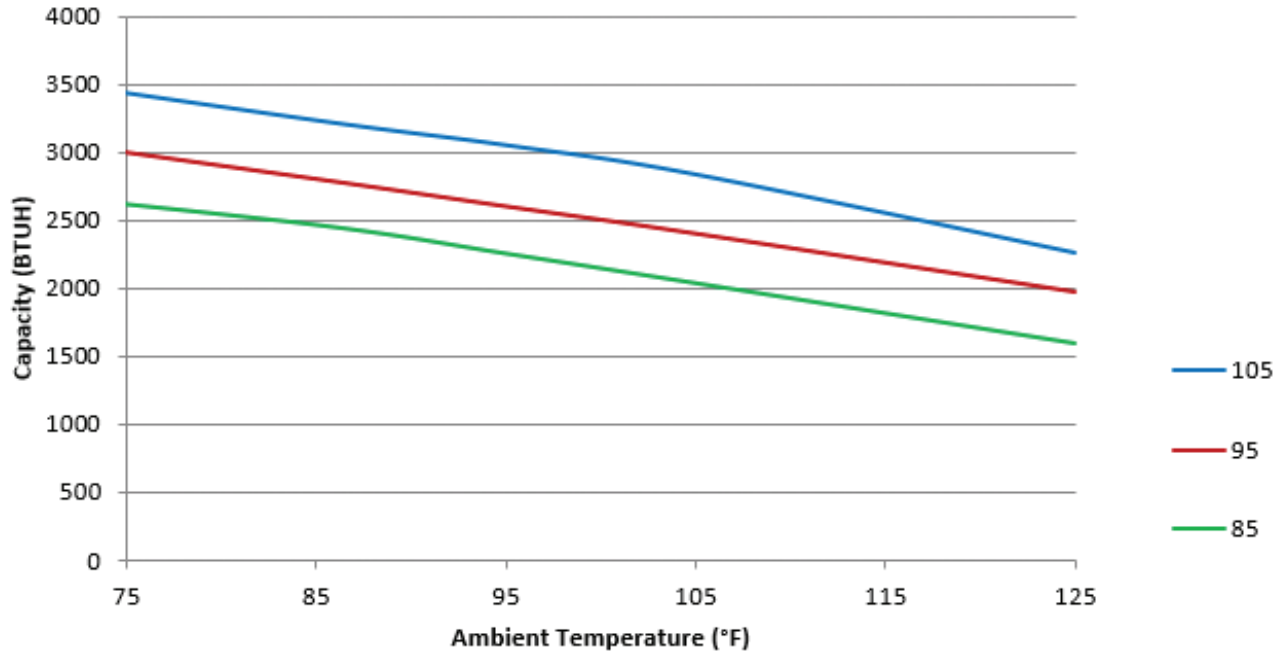

* Critical components in the NRTL Hazardous Location Listing Report must not be substituted with alternate components. Thermal Edge, Inc. and MET Labs must be notified before changes to any drawings, samples, or required documentation are approved.

ATTENTION: If ordering a replacement for a Thermal Edge air conditioner, please include the part number and serial number of the unit being replaced in your order. This will ensure that we ship a replacement that is compatible with the cutout dimensions and power connection features of the older model. All information subject to change without notice.

HAZARDOUS LOCATIONS

2000 BTUH | INDOOR/OUTDOOR, UL TYPES 12, 4 & 4X AVAILABLE

Designed to provide nonincendive cooling for electrical enclosures in hazardous locations, these closed-loop units are ideal for use on systems in chemical and petrochemical, refining, onshore and offshore drilling applications.



OPTIONS:

- Corrosion Protection
- Low Ambient
- Remote Controller
- Controller Programming
- External Heater Control
(for Haz Loc enclosure heaters)
- Extended Temp. Probe
- Dry Contact
- Filter/Filter Frame
- Vibration Resistant
- Custom Finish

Thermal Edge NE02S air conditioners for Hazardous Locations are certified to the following standard(s):*

- ANSI/ISA-12.12.01-2015 Nonincendive Electrical Equipment for use in Class I, Division 2, Groups A, B, C, and D T4 Hazardous (Classified) Locations
- CAN/CSA C22.2 No. 213-15 Nonincendive Electrical Equipment for use in Class I, Division 2, Groups A, B, C, and D T4 Hazardous (Classified) Locations
- $0^{\circ}\text{C} \leq T_a \leq +50^{\circ}\text{C}$

System Features

- For purged and non-purged enclosures
- Active, energy efficient, Condensate Evaporation System
- Fully programmable digital controller with built in alarms and alerts
- Remote controller option places controller inside enclosure
- Thermal Expansion Valve for maximum efficiency when temperature or heat load changes
- Hermetically sealed compressor thermal overload protector
- 2000 BTUH
- Narrow body style fits on 12" enclosure
- Available in UL types 12, 4 and 4X

Unit Efficiency

- Pressure-operated condenser fan reduces power inrush and saves energy
- Highly efficient Rotary Compressor
- Fully insulated & sealed cabinet

Model	UL Type	BTU/Hour	Material	Voltage/Phase/Hz.	Running Amps	Max. Amb. Temp.	H x W x D	Unit Weight (lbs.)
NE02S48612J4	12	2000	Powder coated steel	460/1/60	0.87	134°F	32.02" x 11.83" x 15.06"	94
NE02S48604J4	4	2000	Powder coated steel	460/1/60	0.87	134°F	32.02" x 11.83" x 15.06"	94
NE02S4864XJ4	4X	2000	Stainless steel	460/1/60	0.87	134°F	32.02" x 11.83" x 15.06"	94

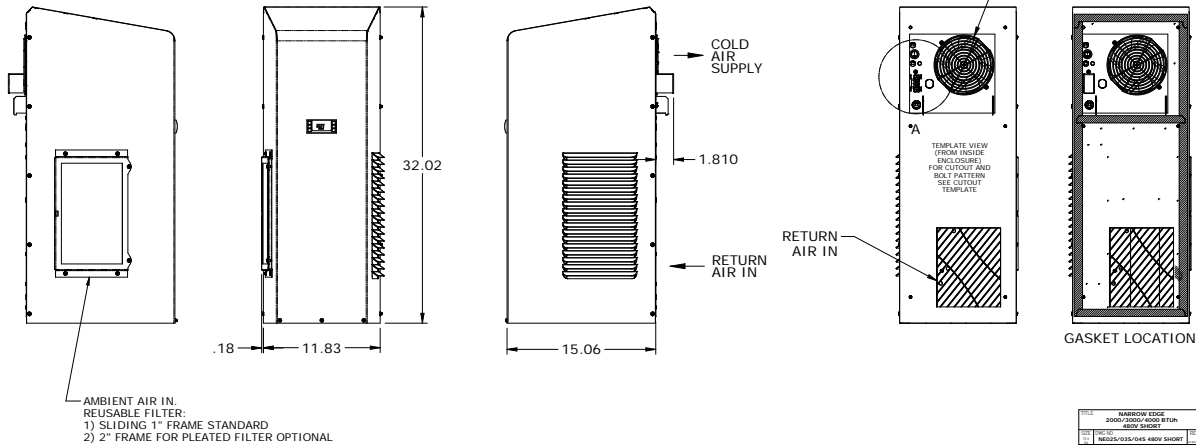
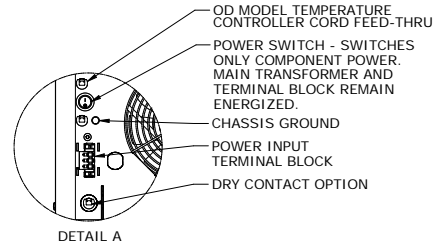
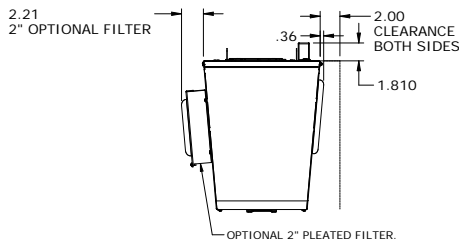
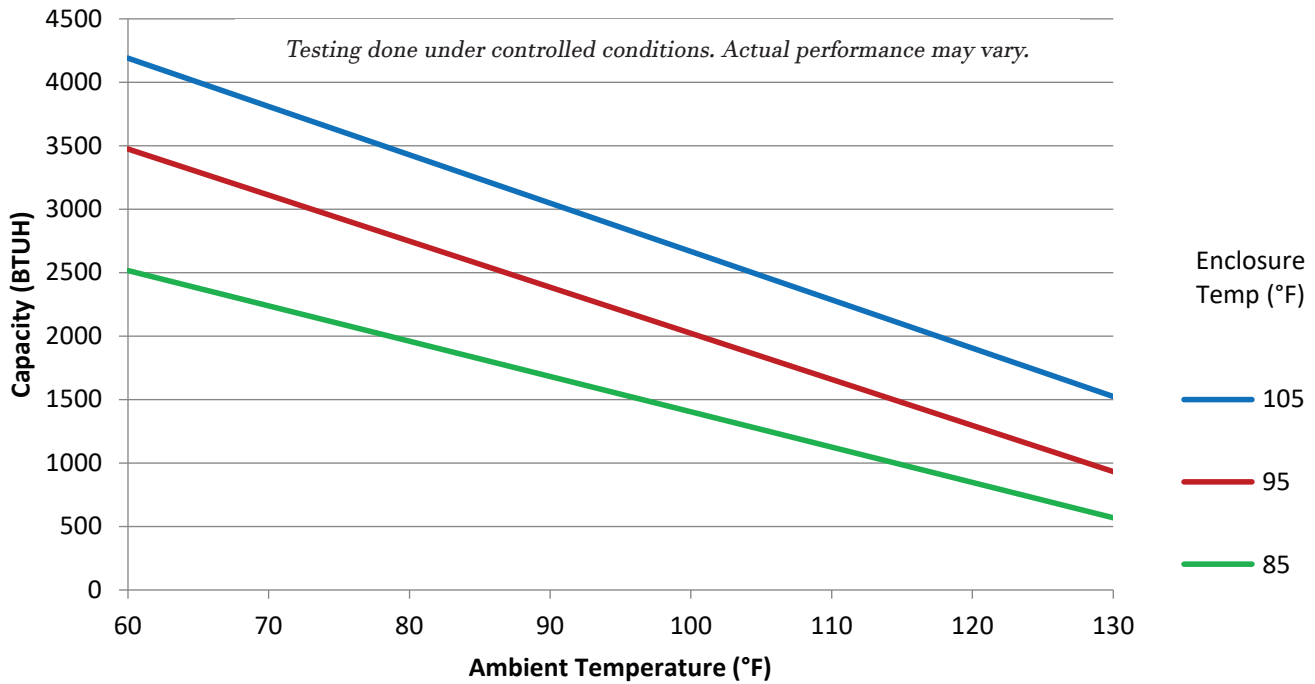

TITLE	NARROW EDGE
NO.	2000/2000/4000 BTUH
REV.	REV. SHEET
DATE	10/03/03
SCALE	1/8" = 1"

* Critical components in the NRTL Hazardous Location Listing Report must not be substituted with alternate components. Thermal Edge, Inc. and MET Labs must be notified before changes to any drawings, samples, or required documentation are approved.

ATTENTION: If ordering a replacement for a Thermal Edge air conditioner, please include the part number and serial number of the unit being replaced in your order. This will ensure that we ship a replacement that is compatible with the cutout dimensions and power connection features of the older model. All information subject to change without notice.

HAZARDOUS LOCATIONS

3000 BTUH | INDOOR/OUTDOOR, UL TYPES 12, 4 & 4X AVAILABLE

Designed to provide nonincendive cooling for electrical enclosures in hazardous locations, these closed-loop units are ideal for use on systems in chemical and petrochemical, refining, onshore and offshore drilling applications.



Thermal Edge NE030 air conditioners for Hazardous Locations are certified to the following standard(s):*

- ANSI/ISA-12.12.01-2015 Nonincendive Electrical Equipment for use in Class I, Division 2, Groups A, B, C, and D T4 Hazardous (Classified) Locations
- CAN/CSA C22.2 No. 213-15 Nonincendive Electrical Equipment for use in Class I, Division 2, Groups A, B, C, and D T4 Hazardous (Classified) Locations
- $0^{\circ}\text{C} \leq T_a \leq +50^{\circ}\text{C}$

System Features

- For purged and non-purged enclosures
- Active, energy efficient, Condensate Evaporation System
- Fully programmable digital controller with built in alarms and alerts
- Remote controller option places controller inside enclosure
- Thermal Expansion Valve for maximum efficiency when temperature or heat load changes
- Hermetically sealed compressor thermal overload protector
- 3000 BTUH
- Narrow body style fits on 12" enclosure
- Available in UL types 12, 4 and 4X

Unit Efficiency

- Pressure-operated condenser fan reduces power inrush and saves energy
- Highly efficient Rotary Compressor
- Fully insulated & sealed cabinet

OPTIONS:

- Corrosion Protection
- Low Ambient
- Remote Controller
- Dry Contact
- Controller Programming
- External Heater Control (for Haz Loc enclosure heaters)
- Filter/Filter Frame
- Extended Temp. Probe
- Vibration Resistant
- Custom Finish

Model	UL Type	BTU/Hour	Material	Voltage/Phase/Hz.	Running Amps	Max. Amb. Temp.	H x W x D	Unit Weight (lbs.)
NE03012612J4	12	3,000	Powder coated steel	115/1/60	4.82	122°F	32" x 11.8" x 9.5"	70
NE03012604J4	4	3,000	Powder coated steel	115/1/60	4.82	122°F	32" x 11.8" x 9.5"	70
NE0301264XJ4	4X	3,000	Stainless steel	115/1/60	4.82	122°F	32" x 11.8" x 9.5"	70
NE03023612J4	12	3,000	Powder coated steel	230/1/60	3.07	122°F	32" x 11.8" x 9.5"	72
NE03023604J4	4	3,000	Powder coated steel	230/1/60	3.07	122°F	32" x 11.8" x 9.5"	72
NE0302364XJ4	4X	3,000	Stainless steel	230/1/60	3.07	122°F	32" x 11.8" x 9.5"	72
NE03048612J4	12	3,000	Powder coated steel	460/1/60	1.15	122°F	38" x 11.8" x 9.5"	103
NE03048604J4	4	3,000	Powder coated steel	460/1/60	1.15	122°F	38" x 11.8" x 9.5"	103
NE0304864XJ4	4X	3,000	Stainless steel	460/1/60	1.15	122°F	38" x 11.8" x 9.5"	103

HAZARDOUS LOCATIONS

3000 BTUH | INDOOR/OUTDOOR, UL TYPES 12, 4 & 4X AVAILABLE

Designed to provide nonincendive cooling for electrical enclosures in hazardous locations, these closed-loop units are ideal for use on systems in chemical and petrochemical, refining, onshore and offshore drilling applications.



OPTIONS:

- Corrosion Protection
- Low Ambient
- Remote Controller
- Dry Contact
- Controller Programming
- External Heater Control (for Haz Loc enclosure heaters)
- Filter/Filter Frame
- Extended Temp. Probe
- Vibration Resistant
- Custom Finish

Thermal Edge NE03S Hazardous Location air conditioners are certified compliant to the following standard(s):*

- ANSI/ISA-12.12.01-2015 Nonincendive Electrical Equipment for use in Class I, Division 2, Groups A, B, C, and D T4 Hazardous (Classified) Locations
- CAN/CSA C22.2 No. 213-15 Nonincendive Electrical Equipment for use in Class I, Division 2, Groups A, B, C, and D T4 Hazardous (Classified) Locations
- $0^{\circ}\text{C} \leq T_{a} \leq +50^{\circ}\text{C}$

System Features

- For purged and non-purged enclosures
- Active, energy efficient, Condensate Evaporation System
- Fully programmable digital controller with built in alarms and alerts
- Remote controller option places controller inside enclosure
- Thermal Expansion Valve for maximum efficiency when temperature or heat load changes
- Hermetically sealed compressor thermal overload protector
- 3000 BTUH
- Narrow body style fits on 12" enclosure
- Available in UL types 12, 4 and 4X

Unit Efficiency

- Pressure-operated condenser fan reduces power inrush and saves energy
- Highly efficient Rotary Compressor
- Fully insulated & sealed cabinet

Model	UL Type	BTU/Hour	Material	Voltage/Phase/Hz.	Running Amps	Max. Amb. Temp.	H x W x D	Unit Weight (lbs.)
NE03S48612J4	12	3000	Powder coated steel	460/1/60	1.28	140°F	32.02" x 11.83" x 15.06"	103
NE03S48604J4	4	3000	Powder coated steel	460/1/60	1.28	140°F	32.02" x 11.83" x 15.06"	103
NE03S4864XJ4	4X	3000	Stainless steel	460/1/60	1.28	140°F	32.02" x 11.83" x 15.06"	103

HAZARDOUS LOCATIONS

4000 BTUH | INDOOR/OUTDOOR, UL TYPES 12, 4 & 4X AVAILABLE

Designed to provide nonincendive cooling for electrical enclosures in hazardous locations, these closed-loop units are ideal for use on systems in chemical and petrochemical, refining, onshore and offshore drilling applications.



Thermal Edge NE040 Hazardous Location air conditioners are certified compliant to the following standard(s):

- ANSI/ISA-12.12.01-2015 Nonincendive Electrical Equipment for use in Class I, Division 2, Groups A, B, C, and D T4 Hazardous (Classified) Locations
- CAN/CSA C22.2 No. 213-15 Nonincendive Electrical Equipment for use in Class I, Division 2, Groups A, B, C, and D T4 Hazardous (Classified) Locations
- 0°C ≤ T_a ≤ +50°C

System Features

- For purged and non-purged enclosures
- Active, energy efficient, Condensate Evaporation System
- Fully programmable digital controller with built in alarms and alerts
- Remote controller option places controller inside enclosure
- Thermal Expansion Valve for maximum efficiency when temperature or heat load changes
- Hermetically sealed compressor thermal overload protector
- 4000 BTUH
- Narrow body style fits on 12" enclosure
- Available in UL types 12, 4 and 4X

Unit Efficiency

- Pressure-operated condenser fan reduces power inrush and saves energy
- Highly efficient Rotary Compressor
- Fully insulated & sealed cabinet

OPTIONS:

- Corrosion Protection
- Low Ambient
- Remote Controller
- Dry Contact
- Controller Programming
- External Heater Control (for Haz Loc enclosure heaters)
- Filter/Filter Frame
- Extended Temp. Probe
- Vibration Resistant
- Custom Finish

Model	UL Type	BTU/Hour	Material	Voltage/Phase/Hz.	Running Amps	Max. Amb. Temp.	H x W x D	Unit Weight (lbs.)
NE04012612J4	12	4,000	Powder coated steel	115/1/60	6.818	122°F	32" x 11.8" x 9.5"	60
NE04012604J4	4	4,000	Powder coated steel	115/1/60	6.818	122°F	32" x 11.8" x 9.5"	60
NE0401264XJ4	4X	4,000	Stainless steel	115/1/60	6.818	122°F	32" x 11.8" x 9.5"	60
NE04023612J4	12	4,000	Powder coated steel	230/1/60	3.07	122°F	32" x 11.8" x 9.5"	72
NE04023604J4	4	4,000	Powder coated steel	230/1/60	3.07	122°F	32" x 11.8" x 9.5"	72
NE0402364XJ4	4X	4,000	Stainless steel	230/1/60	3.07	122°F	32" x 11.8" x 9.5"	72
NE04048612J4	12	4,000	Powder coated steel	460/1/60	1.704	122°F	38" x 11.8" x 9.5"	103
NE04048604J4	4	4,000	Powder coated steel	460/1/60	1.704	122°F	38" x 11.8" x 9.5"	103
NE0404864XJ4	4X	4,000	Stainless steel	460/1/60	1.704	122°F	38" x 11.8" x 9.5"	103

Testing done under controlled conditions. Actual performance may vary.

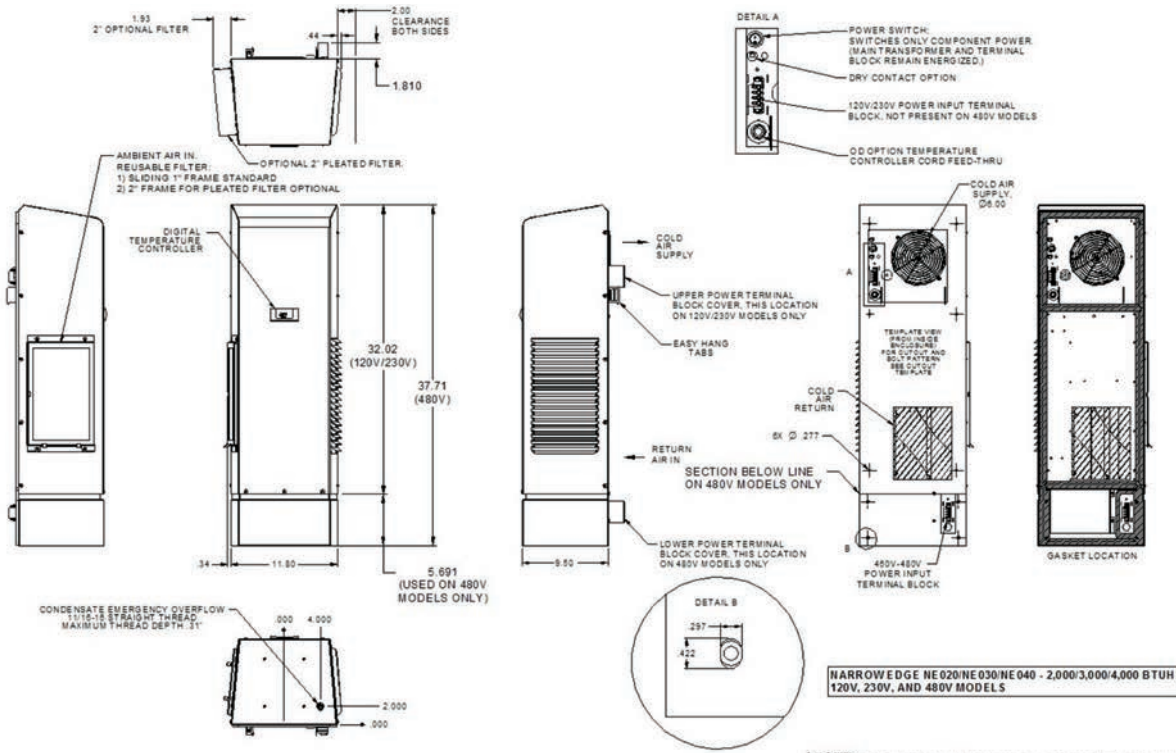
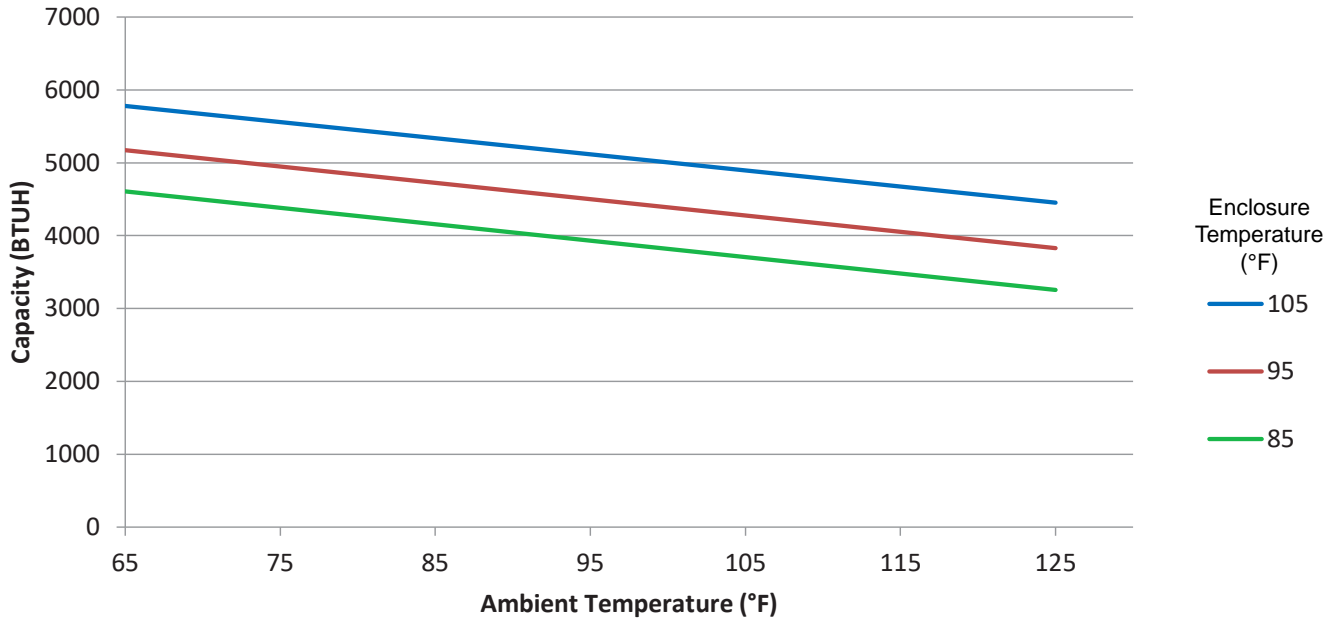

*Critical components in the NRTL Hazardous Location Listing Report must not be substituted with alternate components. Thermal Edge, Inc. and MET Labs must be notified before changes to any drawings, samples, or required documentation are approved.

ATTENTION: If ordering a replacement for a Thermal Edge air conditioner, please include the part number and serial number of the unit being replaced in your order. This will ensure that we ship a replacement that is compatible with the cutout dimensions and power connection features of the older model. All information subject to change without notice.

HAZARDOUS LOCATIONS

4000 BTUH | INDOOR/OUTDOOR, UL TYPES 12, 4 & 4X AVAILABLE

Engineered & manufactured to endure the most difficult of environments and applications. Thermal Edge air conditioners will exceed environmental requirements in applications like Steel, Food Processing, Petro-Chemical, Cement, Paper & Pulp and Plastics.



OPTIONS:

- Corrosion Protection
- Low Ambient
- Remote Controller
- Dry Contact
- Controller Programming
- External Heater Control (for Haz Loc enclosure heaters)
- Filter/Filter Frame
- Extended Temp. Probe
- Vibration Resistant
- Custom Finish

Thermal Edge NE04S Hazardous Location air conditioners are certified compliant to the following standard(s):*

- ANSI/ISA-12.12.01-2015 Nonincendive Electrical Equipment for use in Class I, Division 2, Groups A, B, C, and D T4 Hazardous (Classified) Locations
- CAN/CSA C22.2 No. 213-15 Nonincendive Electrical Equipment for use in Class I, Division 2, Groups A, B, C, and D T4 Hazardous (Classified) Locations
- $0^{\circ}\text{C} \leq T_a \leq +50^{\circ}\text{C}$

System Features

- For purged and non-purged enclosures
- Active, energy efficient, Condensate Evaporation System
- Fully programmable digital controller with built in alarms and alerts
- Remote controller option places controller inside enclosure
- Thermal Expansion Valve for maximum efficiency when temperature or heat load changes
- Hermetically sealed compressor thermal overload protector
- 3000 BTUH
- Narrow body style fits on 12" enclosure
- Available in UL types 12, 4 and 4X

Unit Efficiency

- Pressure-operated condenser fan reduces power inrush and saves energy
- Highly efficient Rotary Compressor
- Fully insulated & sealed cabinet

Model	UL Type	BTU/Hour	Material	Voltage/Phase/Hz.	Running Amps	Max. Amb. Temp.	H x W x D	Unit Weight (lbs.)
NE04S48612J4	12	4000	Powder coated steel	460/1/60	1.69	125°F	32.02" x 11.83" x 15.06"	103
NE04S48604J4	4	4000	Powder coated steel	460/1/60	1.69	125°F	32.02" x 11.83" x 15.06"	103
NE04S4864XJ4	4X	4000	Stainless steel	460/1/60	1.69	125°F	32.02" x 11.83" x 15.06"	103

HAZARDOUS LOCATIONS

5000 BTUH | INDOOR/OUTDOOR, UL TYPES 12, 4 & 4X AVAILABLE

Designed to provide nonincendive cooling for electrical enclosures in hazardous locations, these closed-loop units are ideal for use on systems in chemical and petrochemical, refining, onshore and offshore drilling applications.



Thermal Edge NE050 Hazardous Location air conditioners are certified to the following standard(s):*

- ANSI/ISA-12.12.01-2015 Nonincendive Electrical Equipment for use in Class I, Division 2, Groups A, B, C, and D T4 Hazardous (Classified) Locations
- CAN/CSA C22.2 No. 213-15 Nonincendive Electrical Equipment for use in Class I, Division 2, Groups A, B, C, and D T4 Hazardous (Classified) Locations
- 0°C ≤ T_a ≤ +50°C

System Features

- For purged and non-purged enclosures
- Active, energy efficient, Condensate Evaporation System
- Fully programmable digital controller with built in alarms and alerts
- Remote controller option places controller inside enclosure
- Thermal Expansion Valve for maximum efficiency when temperature or heat load changes
- Hermetically sealed compressor thermal overload protector
- 5000 BTUH
- Narrow body style fits on 12" enclosure
- Available in UL types 12, 4 and 4X

Unit Efficiency

- Pressure-operated condenser fan reduces power inrush and saves energy
- Highly efficient Rotary Compressor
- Fully insulated & sealed cabinet

OPTIONS:

- Corrosion Protection
- Low Ambient
- Remote Controller
- Dry Contact
- Controller Programming
- External Heater Control (for Haz Loc enclosure heaters)
- Filter/Filter Frame
- Extended Temp. Probe
- Vibration Resistant
- Custom Finish

Model	UL Type	BTU/Hour	Material	Voltage/Phase/Hz.	Running Amps	Max. Amb. Temp.	H x W x D	Unit Weight (lbs.)
NE05012612J4	12	5,000	Powder coated steel	115/1/60	6.14	122°F	36" x 11.8" x 15.02"	97
NE05012604J4	4	5,000	Powder coated steel	115/1/60	6.14	122°F	36" x 11.8" x 15.02"	97
NE0501264XJ4	4X	5,000	Stainless steel	115/1/60	6.14	122°F	36" x 11.8" x 15.02"	97
NE05023612J4	12	5,000	Powder coated steel	230/1/60	3.76	122°F	36" x 11.8" x 15.02"	92
NE05023604J4	4	5,000	Powder coated steel	230/1/60	3.76	122°F	36" x 11.8" x 15.02"	92
NE0502364XJ4	4X	5,000	Stainless steel	230/1/60	3.76	122°F	36" x 11.8" x 15.02"	92
NE05048612J4	12	5,000	Powder coated steel	460/1/60	1.9	122°F	44.63" x 11.8" x 15.02"	136
NE05048604J4	4	5,000	Powder coated steel	460/1/60	1.9	122°F	44.63" x 11.8" x 15.02"	136
NE0504864XJ4	4X	5,000	Stainless steel	460/1/60	1.9	122°F	44.63" x 11.8" x 15.02"	136

Testing done under controlled conditions. Actual performance may vary.

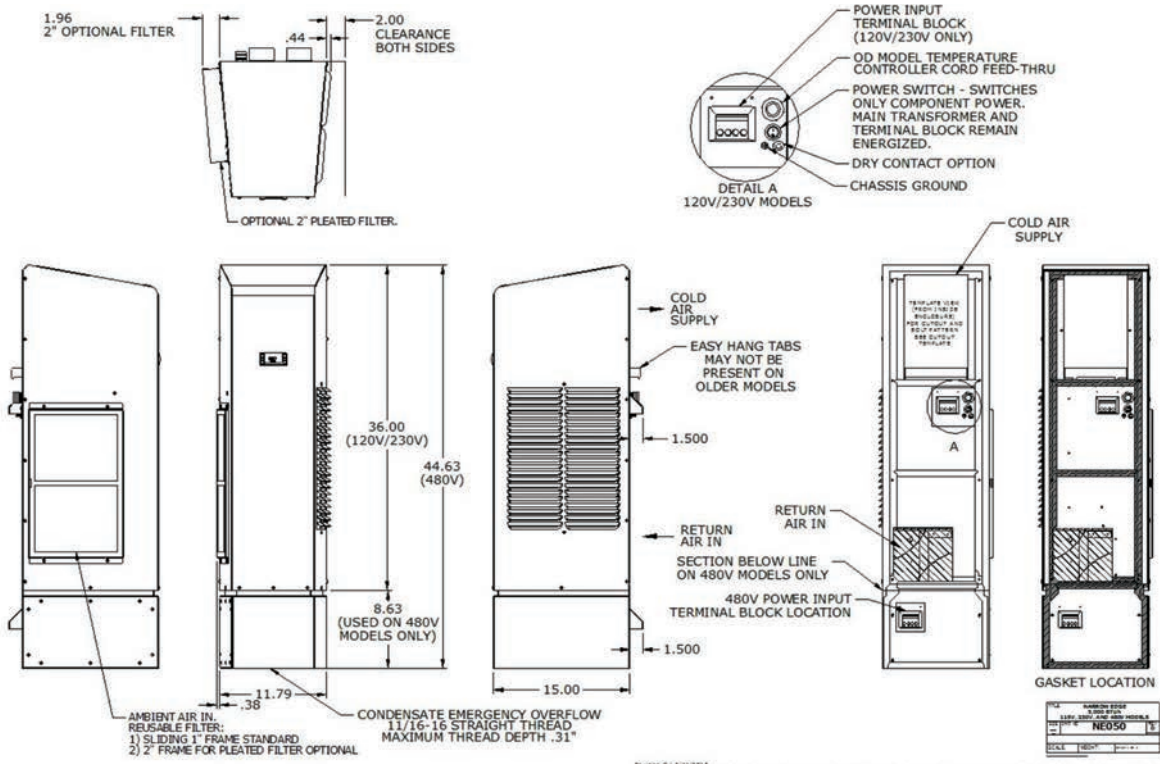
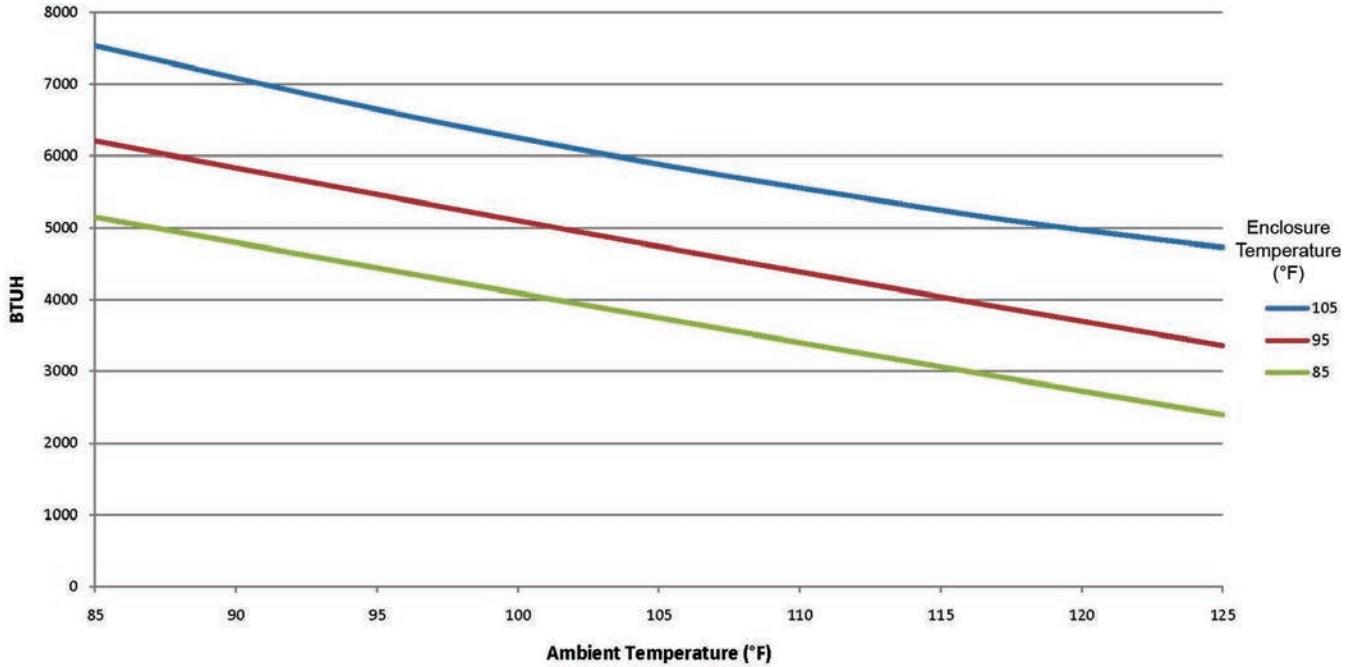

*Critical components in the NRTL Hazardous Location Listing Report must not be substituted with alternate components. Thermal Edge, Inc. and MET Labs must be notified before changes to any drawings, samples, or required documentation are approved.

ATTENTION: If ordering a replacement for a Thermal Edge air conditioner, please include the part number and serial number of the unit being replaced in your order. This will ensure that we ship a replacement that is compatible with the cutout dimensions and power connection features of the older model. All information subject to change without notice.

HAZARDOUS LOCATIONS

6000 BTUH | INDOOR/OUTDOOR, UL TYPES 12, 4 & 4X AVAILABLE

Designed to provide nonincendive cooling for electrical enclosures in hazardous locations, these closed-loop units are ideal for use on systems in chemical and petrochemical, refining, onshore and offshore drilling applications.



OPTIONS:

- Corrosion Protection
- Low Ambient
- Remote Controller
- Dry Contact
- Controller Programming
- External Heater Control
(for Haz Loc enclosure heaters)
- Filter/Filter Frame
- Extended Temp. Probe
- Vibration Resistant
- Custom Finish

Thermal Edge NE060 Hazardous Location air conditioners are certified to the following standard(s):*

- ANSI/ISA-12.12.01-2015 Nonincendive Electrical Equipment for use in Class I, Division 2, Groups A, B, C, and D T4 Hazardous (Classified) Locations
- CAN/CSA C22.2 No. 213-15 Nonincendive Electrical Equipment for use in Class I, Division 2, Groups A, B, C, and D T4 Hazardous (Classified) Locations
- $0^{\circ}\text{C} \leq T_{a} \leq +50^{\circ}\text{C}$

System Features

- For purged and non-purged enclosures
- Active, energy efficient, Condensate Evaporation System
- Fully programmable digital controller with built in alarms and alerts
- Remote controller option places controller inside enclosure
- Thermal Expansion Valve for maximum efficiency when temperature or heat load changes
- Hermetically sealed compressor thermal overload protector
- 6000 BTUH
- Narrow body style fits on 12" enclosure
- Available in UL types 12, 4 and 4X

Unit Efficiency

- Pressure-operated condenser fan reduces power inrush and saves energy
- Highly efficient Rotary Compressor
- Fully insulated & sealed cabinet

Model	UL Type	BTU/Hour	Material	Voltage/Phase/Hz.	Running Amps	Max. Amb. Temp.	H x W x D	Unit Weight (lbs.)
NE06012612J4	12	6,000	Powder coated steel	115/1/60	7.83	122°F	36" x 11.8" x 15.02"	97
NE06012604J4	4	6,000	Powder coated steel	115/1/60	7.83	122°F	36" x 11.8" x 15.02"	97
NE0601264XJ4	4X	6,000	Stainless steel	115/1/60	7.83	122°F	36" x 11.8" x 15.02"	97
NE06023612J4	12	6,000	Powder coated steel	230/1/60	4.8	122°F	36" x 11.8" x 15.02"	98
NE06023604J4	4	6,000	Powder coated steel	230/1/60	4.8	122°F	36" x 11.8" x 15.02"	98
NE0602364XJ4	4X	6,000	Stainless steel	230/1/60	4.8	122°F	36" x 11.8" x 15.02"	98
NE06048612J4	12	6,000	Powder coated steel	460/1/60	2.4	122°F	44.63" x 11.8" x 15.02"	142
NE06048604J4	4	6,000	Powder coated steel	460/1/60	2.4	122°F	44.63" x 11.8" x 15.02"	142
NE0604864XJ4	4X	6,000	Stainless steel	460/1/60	2.4	122°F	44.63" x 11.8" x 15.02"	142

Testing done under controlled conditions. Actual performance may vary.

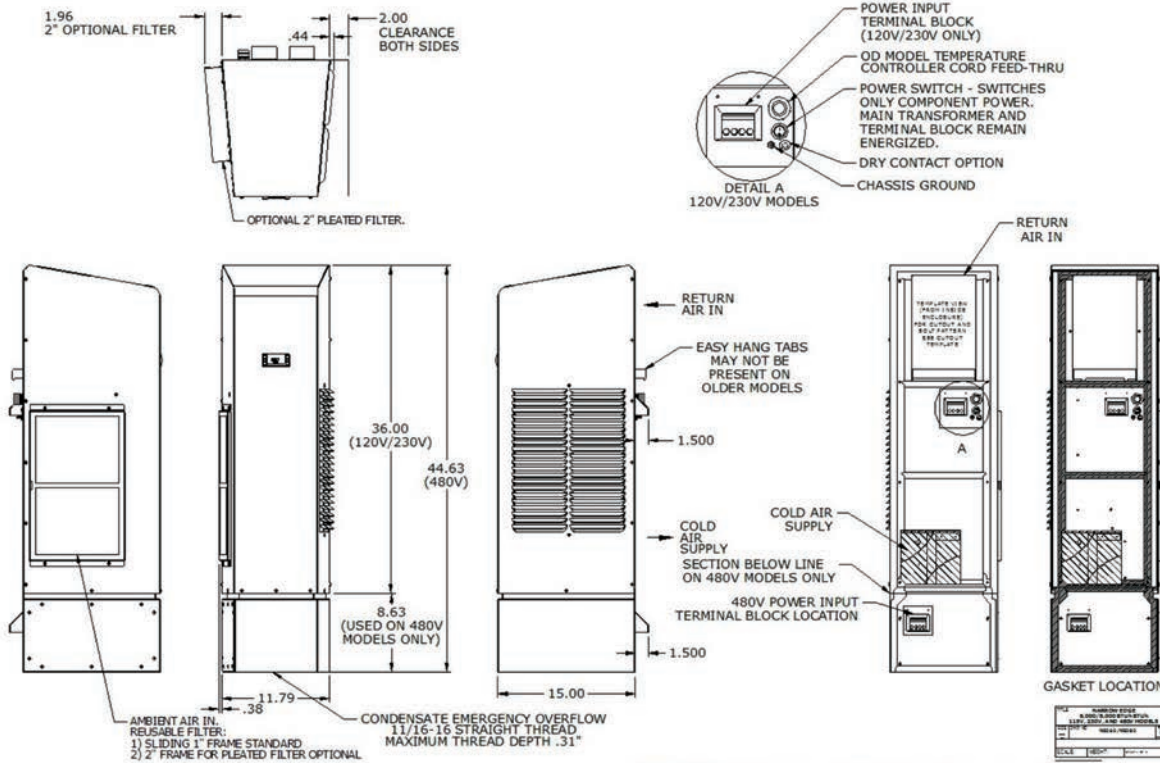
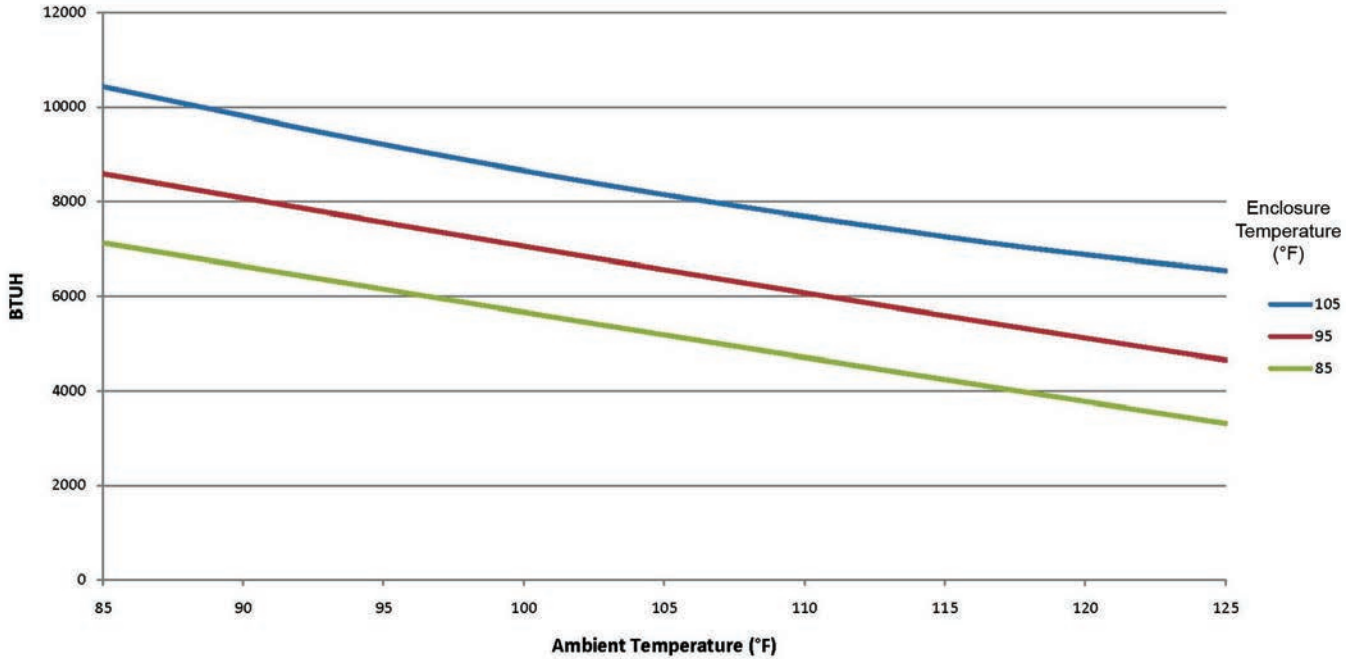

*Critical components in the NRTL Hazardous Location Listing Report must not be substituted with alternate components. Thermal Edge, Inc. and MET Labs must be notified before changes to any drawings, samples, or required documentation are approved.

ATTENTION: If ordering a replacement for a Thermal Edge air conditioner, please include the part number and serial number of the unit being replaced in your order. This will ensure that we ship a replacement that is compatible with the cutout dimensions and power connection features of the older model. All information subject to change without notice.

HAZARDOUS LOCATIONS

6000 BTUH | INDOOR/OUTDOOR, UL TYPES 12, 4 & 4X AVAILABLE

Designed to provide nonincendive cooling for electrical enclosures in hazardous locations, these closed-loop units are ideal for use on systems in chemical and petrochemical, refining, onshore and offshore drilling applications.



Thermal Edge TM061J4 Hazardous Location air conditioners are certified to the following standard(s):*

- ANSI/ISA-12.12.01-2015 Nonincendive Electrical Equipment for use in Class I, Division 2, Groups A, B, C, and D T4 Hazardous (Classified) Locations
- CAN/CSA C22.2 No. 213-15 Nonincendive Electrical Equipment for use in Class I, Division 2, Groups A, B, C, and D T4 Hazardous (Classified) Locations
- $0^{\circ}\text{C} \leq T_a \leq +50^{\circ}\text{C}$

System Features

- For purged and non-purged enclosures
- Active, energy efficient, Condensate Evaporation System
- Fully programmable digital controller with built in alarms and alerts
- Remote controller option places controller inside enclosure
- Thermal Expansion Valve for maximum efficiency when temperature or heat load changes
- Hermetically sealed compressor thermal overload protector
- 6000 BTUH
- Mounts on top of the enclosure
- Available in UL types 12, 4 and 4X

Unit Efficiency

- Highly efficient Rotary Compressor
- Fully insulated & sealed cabinet

OPTIONS:

- Corrosion Protection
- Low Ambient
- Remote Controller
- Dry Contact
- Controller Programming
- External Heater Control (for Haz Loc enclosure heaters)
- Filter/Filter Frame
- Extended Temp. Probe
- Custom Finish

Model	UL Type	BTU/Hour	Material	Voltage/Phase/Hz.	Running Amps	Max. Amb. Temp.	H x W x D	Unit Weight (lbs.)
TM06112612J4	12	6,000	Powder coated steel	115/1/60	10.6	122°F	15.6" x 26.3" x 20.2"	111
TM06112604J4	4	6,000	Powder coated steel	115/1/60	10.6	122°F	15.6" x 30.6" x 20.2"	111
TM0611264XJ4	4X	6,000	Stainless steel	115/1/60	10.6	122°F	15.6" x 30.6" x 20.2"	111
TM06123612J4	12	6,000	Powder coated steel	230/1/60	6	122°F	15.6" x 26.3" x 20.2"	111
TM06123604J4	4	6,000	Powder coated steel	230/1/60	6	122°F	15.6" x 30.6" x 20.2"	111
TM0612364XJ4	4X	6,000	Stainless steel	230/1/60	6	122°F	15.6" x 30.6" x 20.2"	111
TM06148612J4	12	6,000	Powder coated steel	460/1/60	3	122°F	15.6" x 26.3" x 20.2"	154
TM06148604J4	4	6,000	Powder coated steel	460/1/60	3	122°F	15.6" x 30.6" x 20.2"	154
TM0614864XJ4	4X	6,000	Stainless steel	460/1/60	3	122°F	15.6" x 30.6" x 20.2"	154

Testing done under controlled conditions. Actual performance may vary.

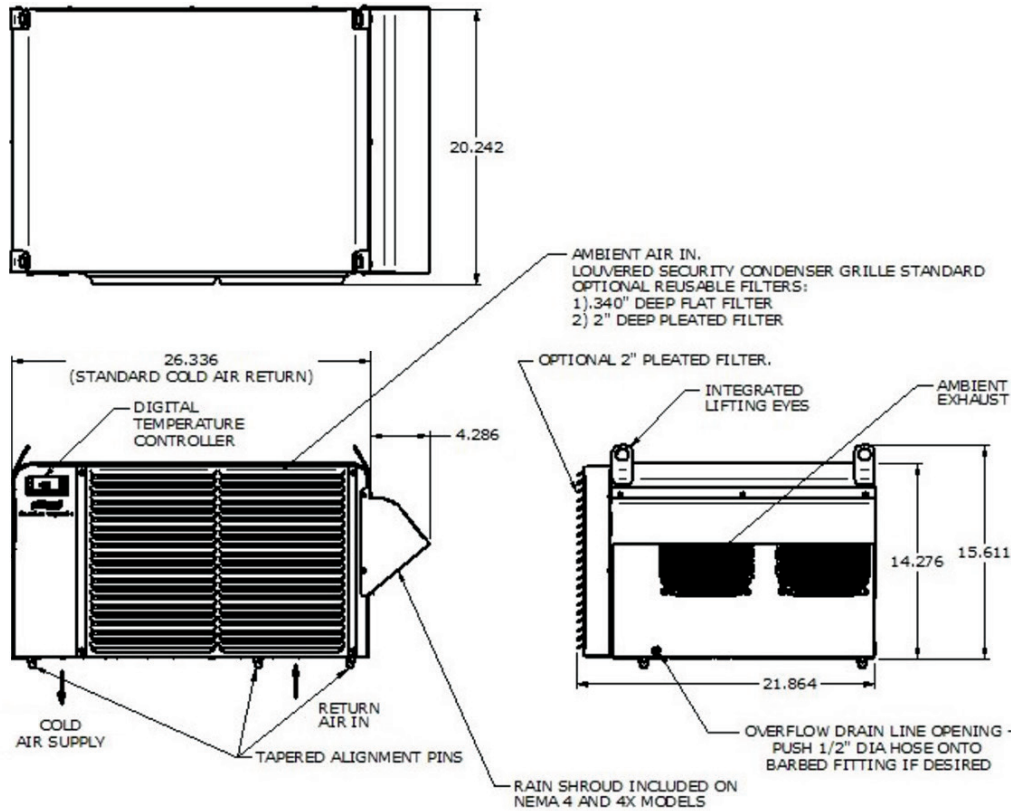
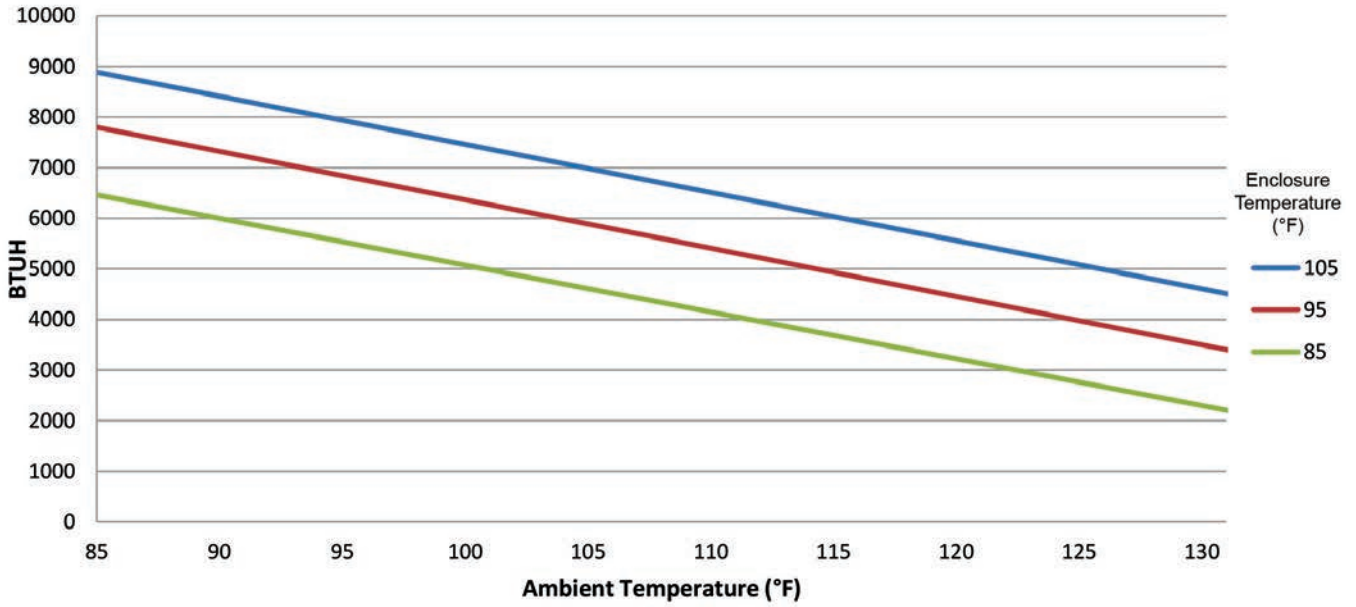

*Critical components in the NRTL Hazardous Location Listing Report must not be substituted with alternate components. Thermal Edge, Inc. and MET Labs must be notified before changes to any drawings, samples, or required documentation are approved.

ATTENTION: If ordering a replacement for a Thermal Edge air conditioner, please include the part number and serial number of the unit being replaced in your order. This will ensure that we ship a replacement that is compatible with the cutout dimensions and power connection features of the older model. All information subject to change without notice.

HAZARDOUS LOCATIONS

8000 BTUH | INDOOR/OUTDOOR, UL TYPES 12, 4 & 4X AVAILABLE

Designed to provide nonincendive cooling for electrical enclosures in hazardous locations, these closed-loop units are ideal for use on systems in chemical and petrochemical, refining, onshore and offshore drilling applications.



OPTIONS:

- Corrosion Protection
- Low Ambient
- Remote Controller
- Dry Contact
- Controller Programming
- External Heater Control (for Haz Loc enclosure heaters)
- Filter/Filter Frame
- Extended Temp. Probe
- Vibration Resistant
- Custom Finish

Thermal Edge NE080 Hazardous Location air conditioners are certified to the following standard(s):*

- ANSI/ISA-12.12.01-2015 Nonincendive Electrical Equipment for use in Class I, Division 2, Groups A, B, C, and D T4 Hazardous (Classified) Locations
- CAN/CSA C22.2 No. 213-15 Nonincendive Electrical Equipment for use in Class I, Division 2, Groups A, B, C, and D T4 Hazardous (Classified) Locations
- 0°C ≤ T_a ≤ +50°C

System Features

- For purged and non-purged enclosures
- Active, energy efficient, Condensate Evaporation System
- Fully programmable digital controller with built in alarms and alerts
- Remote controller option places controller inside enclosure
- Thermal Expansion Valve for maximum efficiency when temperature or heat load changes
- Hermetically sealed compressor thermal overload protector
- 8000 BTUH
- Narrow body style fits on 12" enclosure
- Available in UL types 12, 4 and 4X

Unit Efficiency

- Pressure-operated condenser fan reduces power inrush and saves energy
- Highly efficient Rotary Compressor
- Fully insulated & sealed cabinet

Model	UL Type	BTU/Hour	Material	Voltage/Phase/Hz.	Running Amps	Max. Amb. Temp.	H x W x D	Unit Weight (lbs.)
NE08012612J4	12	8,000	Powder coated steel	115/1/60	7.83	122°F	36" x 11.8" x 15.02"	102
NE08012604J4	4	8,000	Powder coated steel	115/1/60	7.83	122°F	36" x 11.8" x 15.02"	102
NE0801264XJ4	4X	8,000	Stainless steel	115/1/60	7.83	122°F	36" x 11.8" x 15.02"	102
NE08023612J4	12	8,000	Powder coated steel	230/1/60	4.8	122°F	36" x 11.8" x 15.02"	103
NE08023604J4	4	8,000	Powder coated steel	230/1/60	4.8	122°F	36" x 11.8" x 15.02"	103
NE0802364XJ4	4X	8,000	Stainless steel	230/1/60	4.8	122°F	36" x 11.8" x 15.02"	103
NE08048612J4	12	8,000	Powder coated steel	460/1/60	2.4	122°F	44.63" x 11.8" x 15.02"	142
NE08048604J4	4	8,000	Powder coated steel	460/1/60	2.4	122°F	44.63" x 11.8" x 15.02"	142
NE0804864XJ4	4X	8,000	Stainless steel	460/1/60	2.4	122°F	44.63" x 11.8" x 15.02"	142

Testing done under controlled conditions. Actual performance may vary.

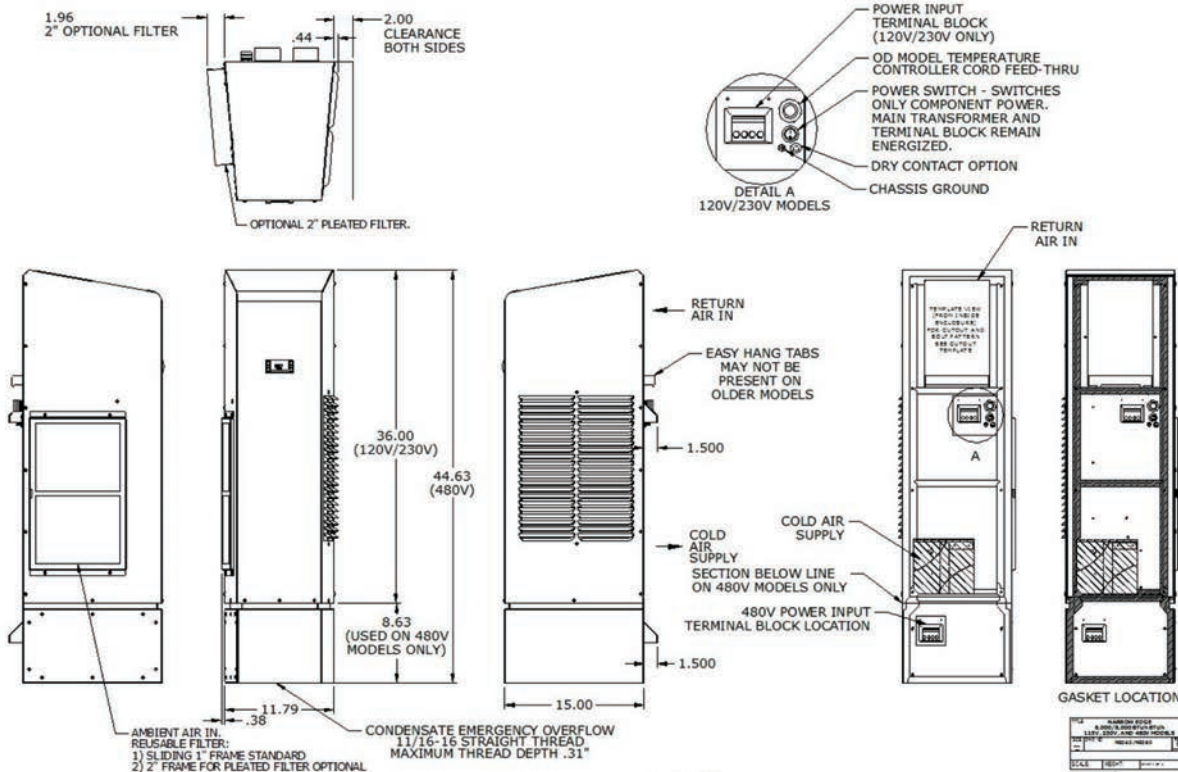
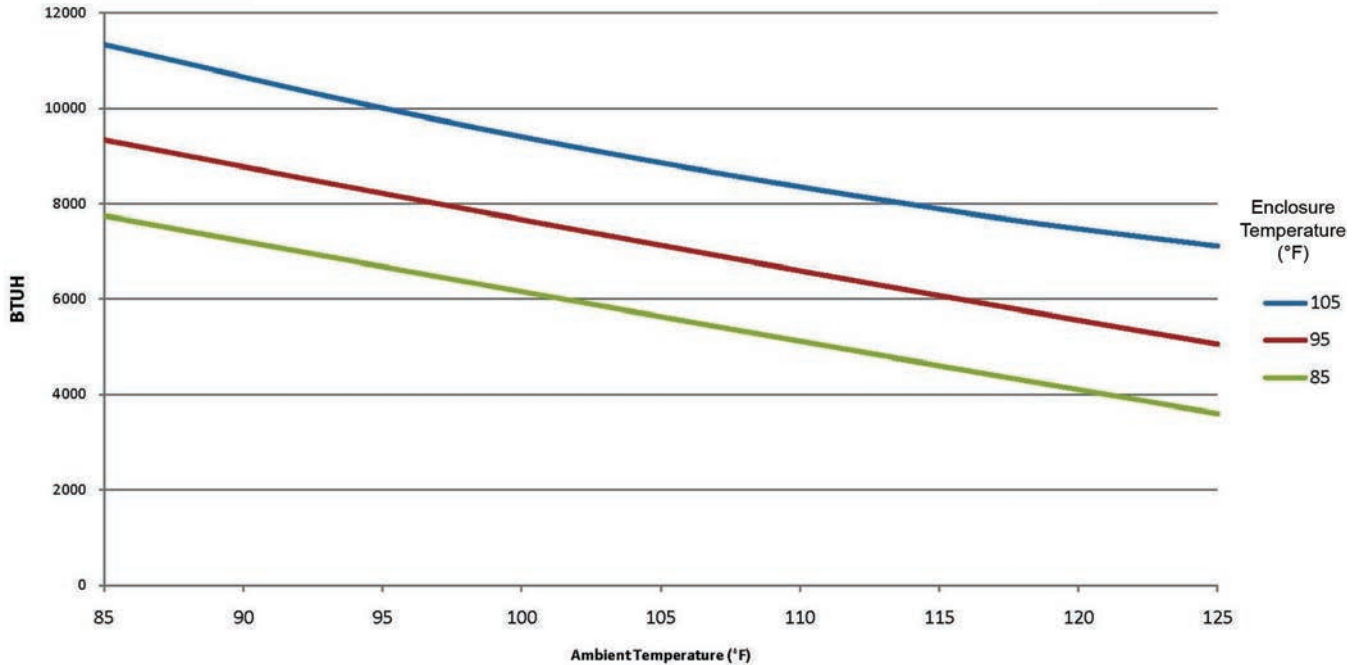

*Critical components in the NRTL Hazardous Location Listing Report must not be substituted with alternate components. Thermal Edge, Inc. and MET Labs must be notified before changes to any drawings, samples, or required documentation are approved.

ATTENTION: If ordering a replacement for a Thermal Edge air conditioner, please include the part number and serial number of the unit being replaced in your order. This will ensure that we ship a replacement that is compatible with the cutout dimensions and power connection features of the older model. All information subject to change without notice.

HAZARDOUS LOCATIONS

8000 BTUH | INDOOR/OUTDOOR, UL TYPES 12, 4 & 4X AVAILABLE

Designed to provide nonincendive cooling for electrical enclosures in hazardous locations, these closed-loop units are ideal for use on systems in chemical and petrochemical, refining, onshore and offshore drilling applications.



Thermal Edge TM081J4 Hazardous Location air conditioners are certified to the following standard(s):*

- ANSI/ISA-12.12.01-2015 Nonincendive Electrical Equipment for use in Class I, Division 2, Groups A, B, C, and D T4 Hazardous (Classified) Locations
- CAN/CSA C22.2 No. 213-15 Nonincendive Electrical Equipment for use in Class I, Division 2, Groups A, B, C, and D T4 Hazardous (Classified) Locations
- $0^{\circ}\text{C} \leq T_a \leq +50^{\circ}\text{C}$

System Features

- For purged and non-purged enclosures
- Active, energy efficient, Condensate Evaporation System
- Fully programmable digital controller with built in alarms and alerts
- Remote controller option places controller inside enclosure
- Thermal Expansion Valve for maximum efficiency when temperature or heat load changes
- Hermetically sealed compressor thermal overload protector
- 8000 BTUH
- Mounts on top of the enclosure
- Available in UL types 12, 4 and 4X

Unit Efficiency

- Highly efficient Rotary Compressor
- Fully insulated & sealed cabinet

OPTIONS:

- Corrosion Protection
- Low Ambient
- Remote Controller
- Dry Contact
- Controller Programming
- External Heater Control (for Haz Loc enclosure heaters)
- Filter/Filter Frame
- Extended Temp. Probe
- Custom Finish

Model	UL Type	BTU/Hour	Material	Voltage/Phase/Hz.	Running Amps	Max. Amb. Temp.	H x W x D	Unit Weight (lbs.)
TM08112612J4	12	8,000	Powder coated steel	115/1/60	11.6	122°F	15.6" x 26.3" x 20.2"	111
TM08112604J4	4	8,000	Powder coated steel	115/1/60	11.6	122°F	15.6" x 30.6" x 20.2"	111
TM0811264XJ4	4X	8,000	Stainless steel	115/1/60	11.6	122°F	15.6" x 30.6" x 20.2"	111
TM08123612J4	12	8,000	Powder coated steel	230/1/60	7	122°F	15.6" x 26.3" x 20.2"	111
TM08123604J4	4	8,000	Powder coated steel	230/1/60	7	122°F	15.6" x 30.6" x 20.2"	111
TM0812364XJ4	4X	8,000	Stainless steel	230/1/60	7	122°F	15.6" x 30.6" x 20.2"	111
TM08148612J4	12	8,000	Powder coated steel	460/1/60	3.5	122°F	15.6" x 26.3" x 20.2"	154
TM08148604J4	4	8,000	Powder coated steel	460/1/60	3.5	122°F	15.6" x 30.6" x 20.2"	154
TM0814864XJ4	4X	8,000	Stainless steel	460/1/60	3.5	122°F	15.6" x 30.6" x 20.2"	154

Testing done under controlled conditions. Actual performance may vary.

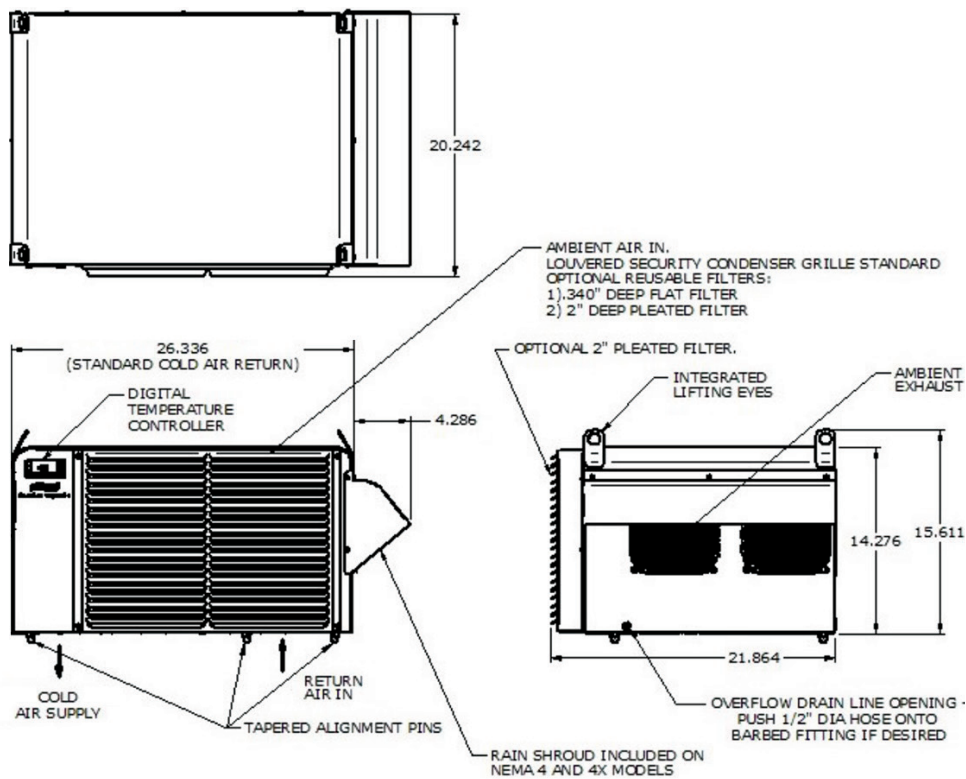
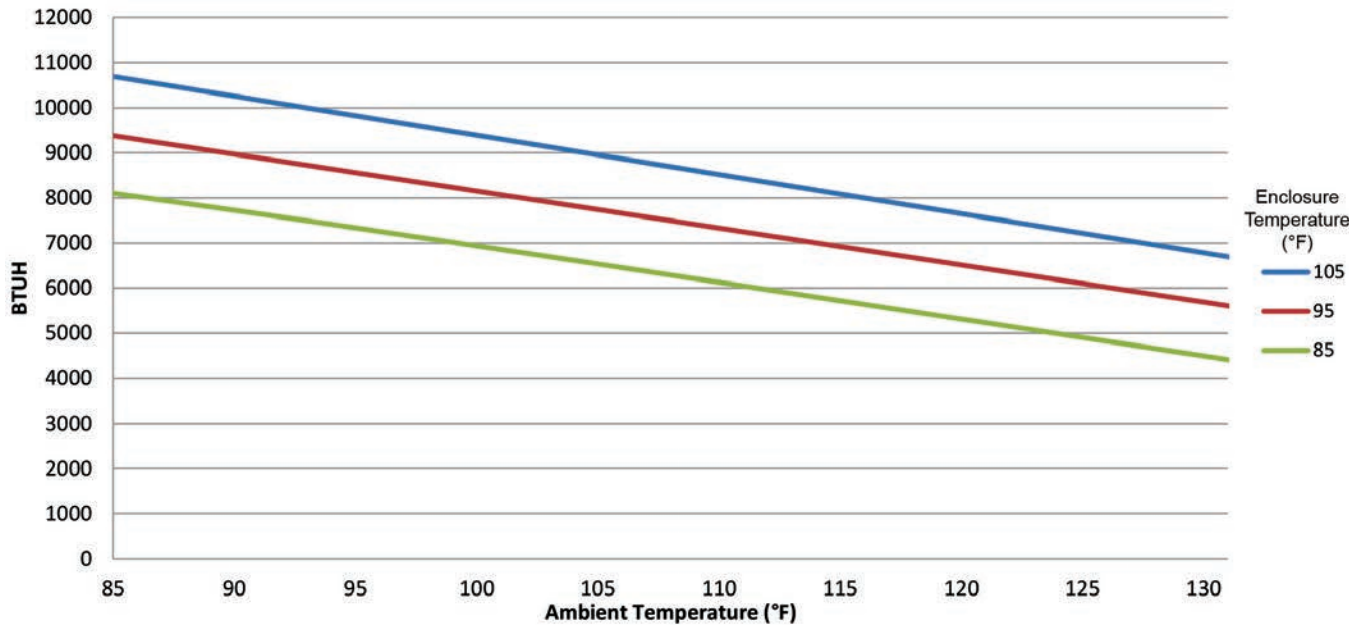

*Critical components in the NRTL Hazardous Location Listing Report must not be substituted with alternate components. Thermal Edge, Inc. and MET Labs must be notified before changes to any drawings, samples, or required documentation are approved.

ATTENTION: If ordering a replacement for a Thermal Edge air conditioner, please include the part number and serial number of the unit being replaced in your order. This will ensure that we ship a replacement that is compatible with the cutout dimensions and power connection features of the older model. All information subject to change without notice.

HAZARDOUS LOCATIONS

10,000 BTUH | INDOOR/OUTDOOR, UL TYPES 12, 4 & 4X AVAILABLE

Designed to provide nonincendive cooling for electrical enclosures in hazardous locations, these closed-loop units are ideal for use on systems in chemical and petrochemical, refining, onshore and offshore drilling applications.



OPTIONS:

- Corrosion Protection
- Low Ambient
- Remote Controller
- Dry Contact
- Controller Programming
- External Heater Control
(for Haz Loc enclosure heaters)
- Filter/Filter Frame
- Extended Temp. Probe
- Custom Finish

Thermal Edge HC101 Hazardous Location air conditioners are certified to the following standard(s):*

- ANSI/ISA-12.12.01-2015 Nonincendive Electrical Equipment for use in Class I, Division 2, Groups A, B, C, and D T4 Hazardous (Classified) Locations
- CAN/CSA C22.2 No. 213-15 Nonincendive Electrical Equipment for use in Class I, Division 2, Groups A, B, C, and D T4 Hazardous (Classified) Locations
- 0°C ≤ T_a ≤ +50°C

System Features

- For purged and non-purged enclosures
- Active, energy efficient, Condensate Evaporation System
- Fully programmable digital controller with built in alarms and alerts
- Remote controller option places controller inside enclosure
- Thermal Expansion Valve for maximum efficiency when temperature or heat load changes
- Hermetically sealed compressor thermal overload protector
- 10,000 BTUH
- Available in UL types 12, 4 and 4X

Unit Efficiency

- Pressure-operated condenser fan reduces power inrush and saves energy
- Highly efficient Rotary Compressor
- Fully insulated & sealed cabinet

Model	UL Type	BTU/Hour	Material	Voltage/Phase/Hz.	Running Amps	Max. Amb. Temp.	H x W x D	Unit Weight (lbs.)
HC10112612J4	12	10,000	Powder coated steel	115/1/60	19.4	122°F	48" x 15.86" x 15.03"	162
HC10112604J4	4	10,000	Powder coated steel	115/1/60	19.4	122°F	48" x 15.86" x 15.03"	162
HC1011264XJ4	4X	10,000	Stainless steel	115/1/60	19.4	122°F	48" x 15.86" x 15.03"	162
HC10123612J4	12	10,000	Powder coated steel	230/1/60	8.2	122°F	48" x 15.86" x 15.03"	166
HC10123604J4	4	10,000	Powder coated steel	230/1/60	8.2	122°F	48" x 15.86" x 15.03"	166
HC1012364XJ4	4X	10,000	Stainless steel	230/1/60	8.2	122°F	48" x 15.86" x 15.03"	166
HC10148612J4	12	10,000	Powder coated steel	460/1/60	4.1	122°F	57.6" x 15.86" x 15.03"	232
HC10148604J4	4	10,000	Powder coated steel	460/1/60	4.1	122°F	57.6" x 15.86" x 15.03"	232
HC1014864XJ4	4X	10,000	Stainless steel	460/1/60	4.1	122°F	57.6" x 15.86" x 15.03"	232

Testing done under controlled conditions. Actual performance may vary.

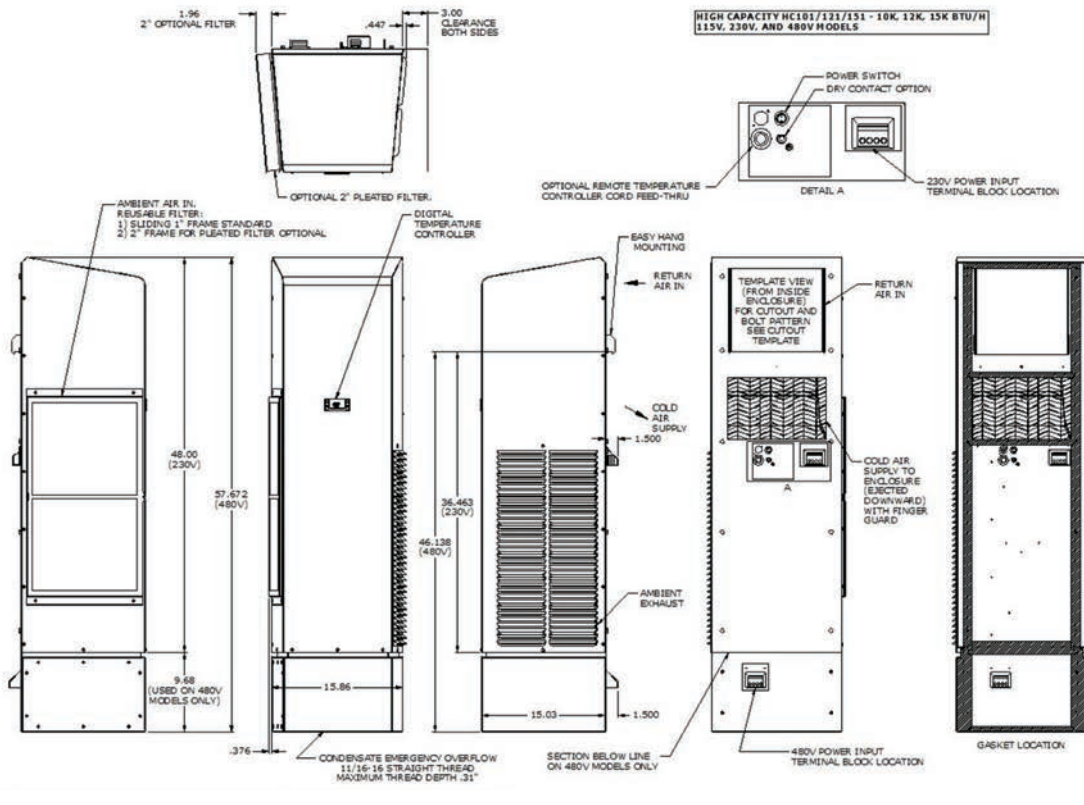
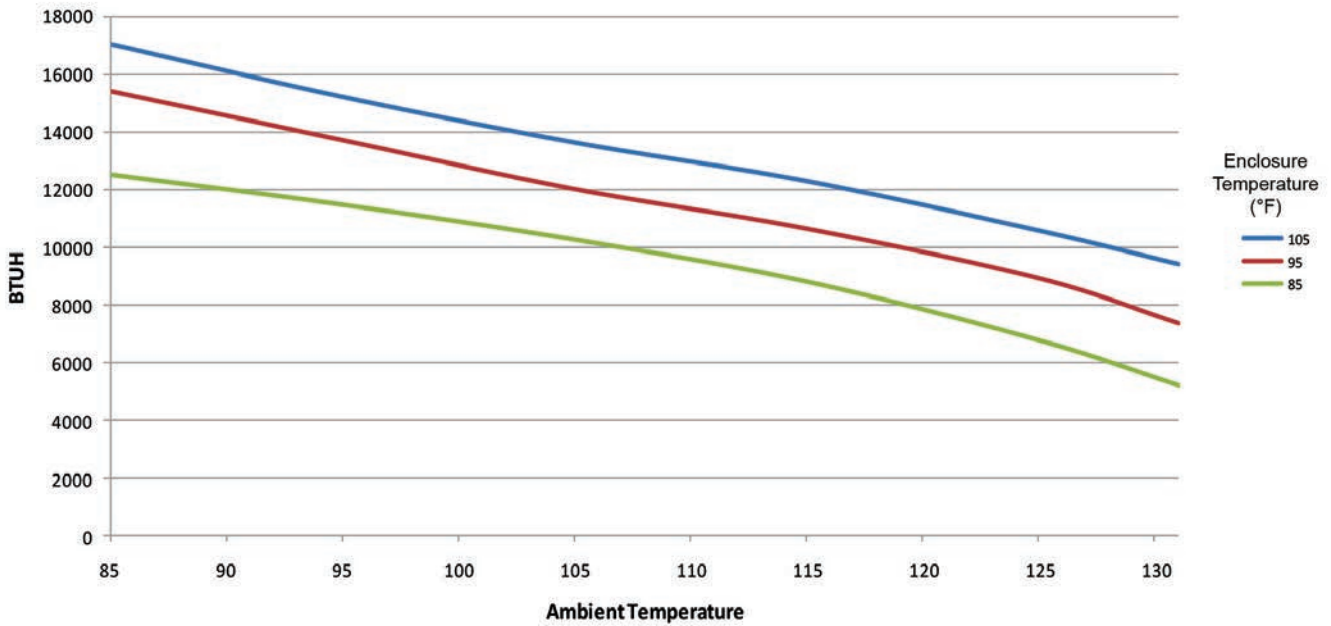

*Critical components in the NRTL Hazardous Location Listing Report must not be substituted with alternate components. Thermal Edge, Inc. and MET Labs must be notified before changes to any drawings, samples, or required documentation are approved.

ATTENTION: If ordering a replacement for a Thermal Edge air conditioner, please include the part number and serial number of the unit being replaced in your order. This will ensure that we ship a replacement that is compatible with the cutout dimensions and power connection features of the older model. All information subject to change without notice.

HAZARDOUS LOCATIONS

12,000 BTUH | INDOOR/OUTDOOR, UL TYPES 12, 4 & 4X AVAILABLE

Designed to provide nonincendive cooling for electrical enclosures in hazardous locations, these closed-loop units are ideal for use on systems in chemical and petrochemical, refining, onshore and offshore drilling applications.



Thermal Edge HC121 Hazardous Location air conditioners are certified to the following standard(s):*

- ANSI/ISA-12.12.01-2015 Nonincendive Electrical Equipment for use in Class I, Division 2, Groups A, B, C, and D T4 Hazardous (Classified) Locations
- CAN/CSA C22.2 No. 213-15 Nonincendive Electrical Equipment for use in Class I, Division 2, Groups A, B, C, and D T4 Hazardous (Classified) Locations
- $0^{\circ}\text{C} \leq T_a \leq +50^{\circ}\text{C}$

System Features

- For purged and non-purged enclosures
- Active, energy efficient, Condensate Evaporation System
- Fully programmable digital controller with built in alarms and alerts
- Remote controller option places controller inside enclosure
- Thermal Expansion Valve for maximum efficiency when temperature or heat load changes
- Hermetically sealed compressor thermal overload protector
- 12,000 BTUH
- Available in UL types 12, 4 and 4X

Unit Efficiency

- Pressure-operated condenser fan reduces power inrush and saves energy
- Highly efficient Rotary Compressor
- Fully insulated & sealed cabinet

OPTIONS:

- Corrosion Protection
- Low Ambient
- Remote Controller
- Dry Contact
- Controller Programming
- External Heater Control (for Haz Loc enclosure heaters)
- Filter/Filter Frame
- Extended Temp. Probe
- Custom Finish

Model	UL Type	BTU/Hour	Material	Voltage/Phase/Hz.	Running Amps	Max. Amb. Temp.	H x W x D	Unit Weight (lbs.)
HC12112612J4	12	12,000	Powder coated steel	115/1/60	19.4	122°F	48" x 15.86" x 15.03"	167
HC12112604J4	4	12,000	Powder coated steel	115/1/60	19.4	122°F	48" x 15.86" x 15.03"	167
HC1211264XJ4	4X	12,000	Stainless steel	115/1/60	19.4	122°F	48" x 15.86" x 15.03"	167
HC12123612J4	12	12,000	Powder coated steel	230/1/60	8.2	122°F	48" x 15.86" x 15.03"	163
HC12123604J4	4	12,000	Powder coated steel	230/1/60	8.2	122°F	48" x 15.86" x 15.03"	163
HC1212364XJ4	4X	12,000	Stainless steel	230/1/60	8.2	122°F	48" x 15.86" x 15.03"	163
HC12148612J4	12	12,000	Powder coated steel	460/1/60	4.1	122°F	57.6" x 15.86" x 15.03"	237
HC12148604J4	4	12,000	Powder coated steel	460/1/60	4.1	122°F	57.6" x 15.86" x 15.03"	237
HC1214864XJ4	4X	12,000	Stainless steel	460/1/60	4.1	122°F	57.6" x 15.86" x 15.03"	237

Testing done under controlled conditions. Actual performance may vary.

HC121

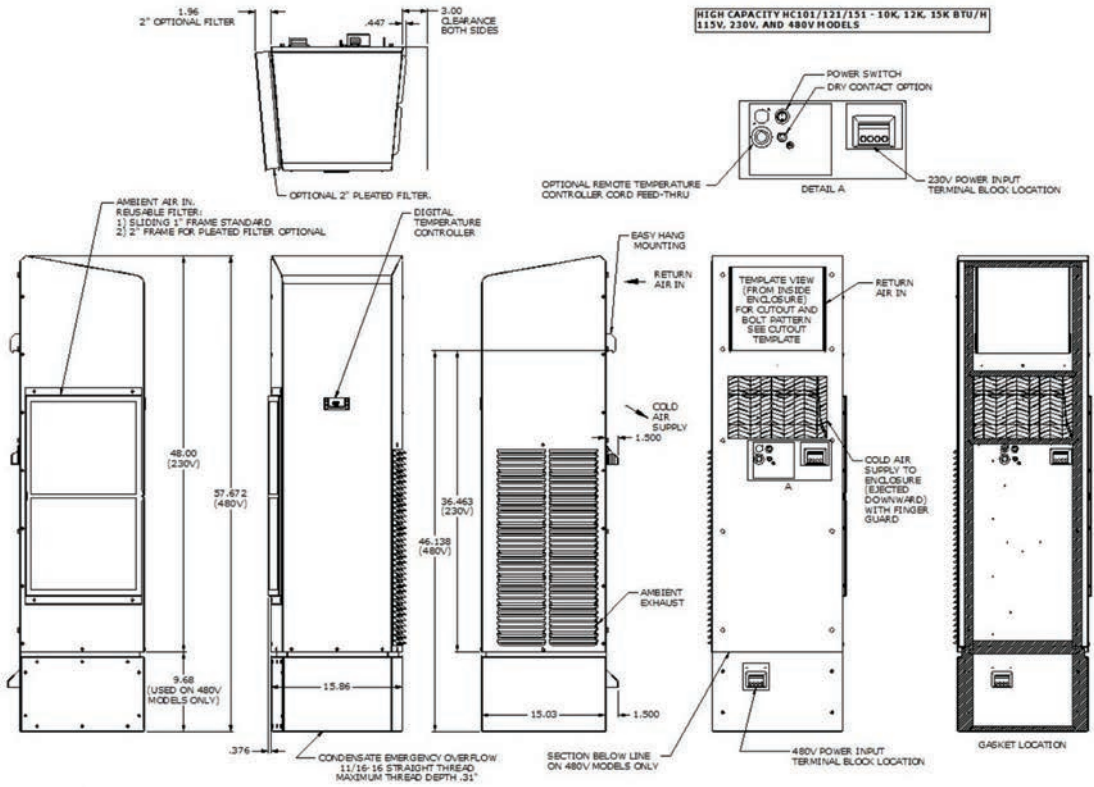
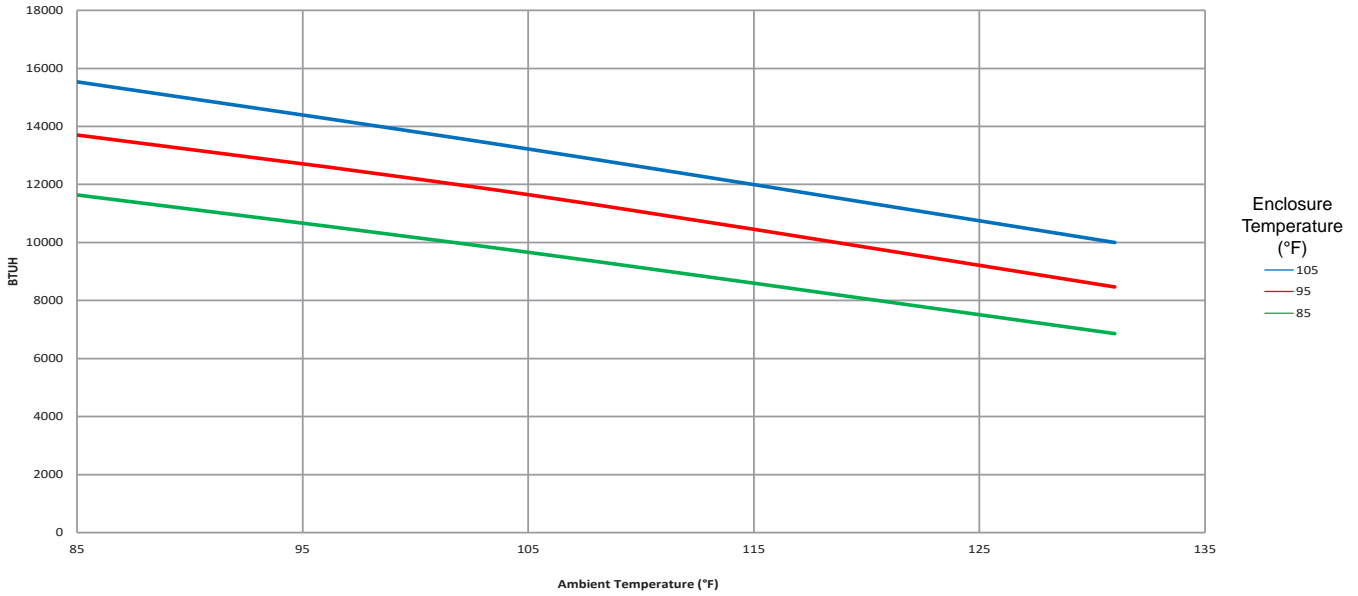

*Critical components in the NRTL Hazardous Location Listing Report must not be substituted with alternate components. Thermal Edge, Inc. and MET Labs must be notified before changes to any drawings, samples, or required documentation are approved.

ATTENTION: If ordering a replacement for a Thermal Edge air conditioner, please include the part number and serial number of the unit being replaced in your order. This will ensure that we ship a replacement that is compatible with the cutout dimensions and power connection features of the older model. All information subject to change without notice.

HAZARDOUS LOCATIONS

20,000 BTUH | INDOOR/OUTDOOR, UL TYPES 12, 4 & 4X AVAILABLE

Designed to provide nonincendive cooling for electrical enclosures in hazardous locations, these closed-loop units are ideal for use on systems in chemical and petrochemical, refining, onshore and offshore drilling applications.



OPTIONS:

- Corrosion Protection
- Low Ambient
- Remote Controller
- Dry Contact
- Controller Programming
- External Heater Control (for Haz Loc enclosure heaters)
- Filter/Filter Frame
- Extended Temp. Probe
- Custom Finish

Thermal Edge HC20CJ4 Hazardous Location air conditioners are certified to the following standard(s):*

- ANSI/ISA-12.12.01-2015 Nonincendive Electrical Equipment for use in Class I, Division 2, Groups A, B, C, and D T4 Hazardous (Classified) Locations
- CAN/CSA C22.2 No. 213-15 Nonincendive Electrical Equipment for use in Class I, Division 2, Groups A, B, C, and D T4 Hazardous (Classified) Locations
- 0°C ≤ T_a ≤ +50°C

System Features

- For purged and non-purged enclosures
- Active, energy efficient, Condensate Evaporation System
- Fully programmable digital controller with built in alarms and alerts
- Remote controller option places controller inside enclosure
- Thermal Expansion Valve for maximum efficiency when temperature or heat load changes
- Hermetically sealed compressor thermal overload protector
- 20,000 BTUH
- Available in UL types 12, 4 and 4X

Unit Efficiency

- Pressure-operated condenser fan reduces power inrush and saves energy
- Highly efficient Rotary Compressor
- Fully insulated & sealed cabinet

Model	UL Type	Material	Voltage/Phase/Hz.	Running Amps	Max. Amb. Temp.	H x W x D	Unit Weight (lbs.)
HC20C23612J4	12	Powder coated steel	230/1/60	12.47	122°F	48" x 15.86" x 15.03"	170
HC20C23604J4	4	Powder coated steel	230/1/60	12.47	122°F	48" x 15.86" x 15.03"	170
HC20C2364XJ4	4X	Stainless steel	230/1/60	12.47	122°F	48" x 15.86" x 15.03"	170
HC20C48612J4	12	Powder coated steel	460/1/60	6.3	122°F	57.6" x 15.86" x 15.03"	247
HC20C48604J4	4	Powder coated steel	460/1/60	6.3	122°F	57.6" x 15.86" x 15.03"	247
HC20C4864XJ4	4X	Stainless steel	460/1/60	6.3	122°F	57.6" x 15.86" x 15.03"	247

Testing done under controlled conditions. Actual performance may vary.

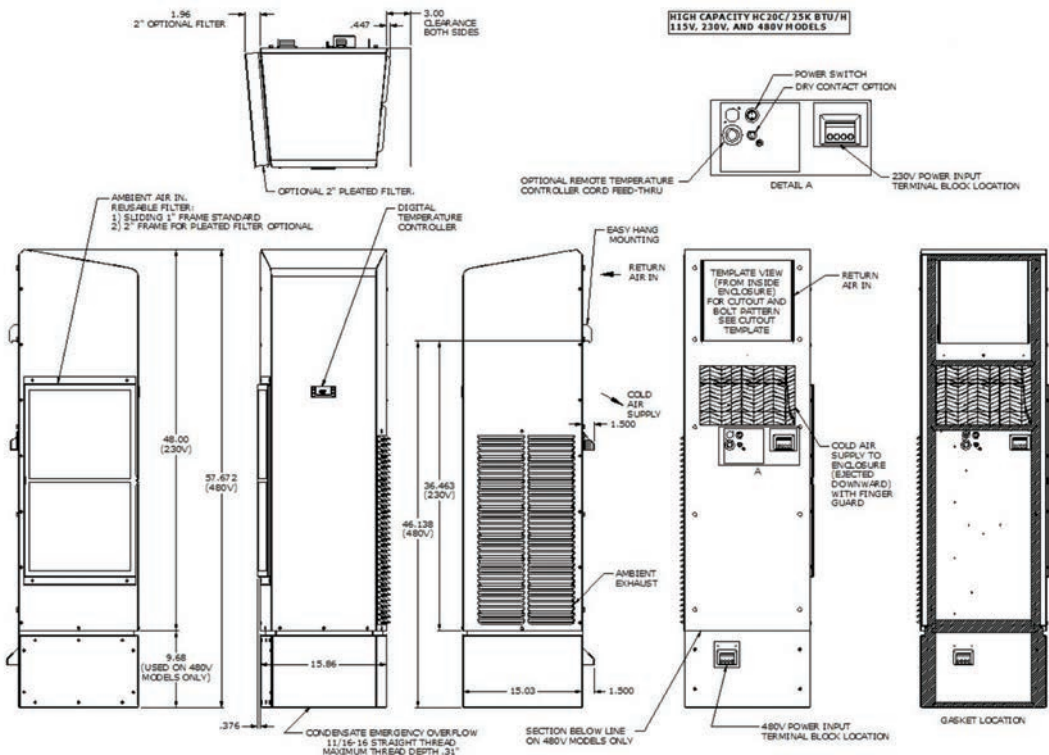
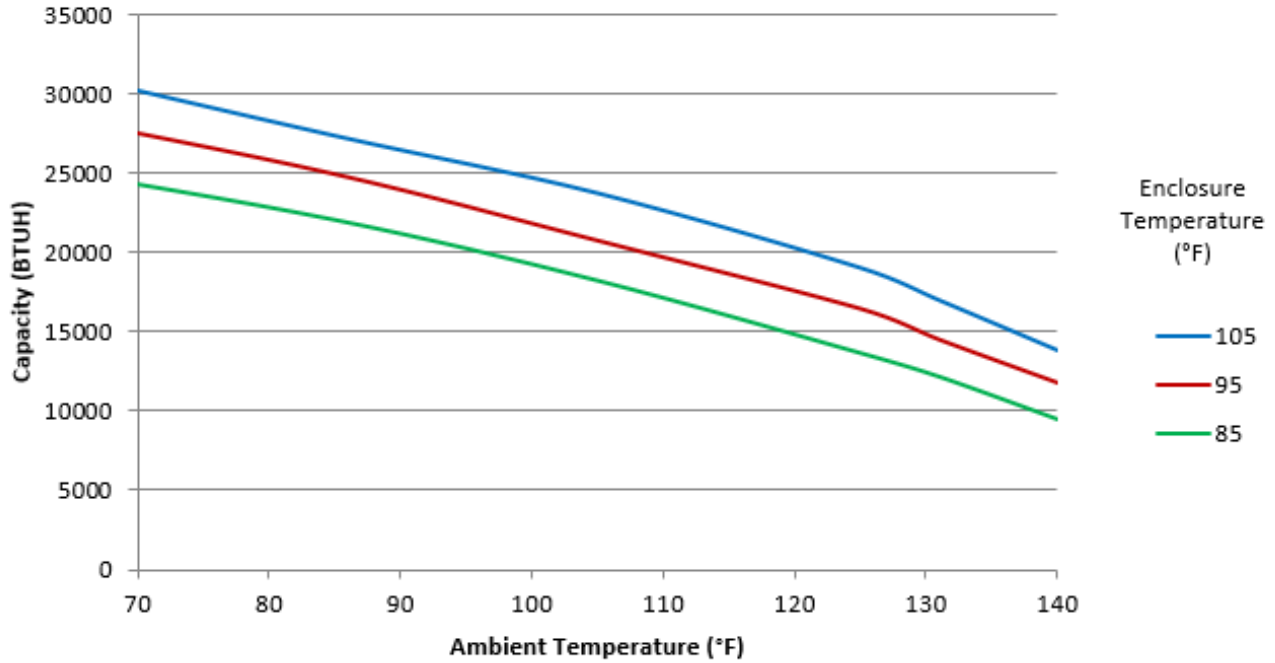

*Critical components in the NRTL Hazardous Location Listing Report must not be substituted with alternate components. Thermal Edge, Inc. and MET Labs must be notified before changes to any drawings, samples, or required documentation are approved.

ATTENTION: If ordering a replacement for a Thermal Edge air conditioner, please include the part number and serial number of the unit being replaced in your order. This will ensure that we ship a replacement that is compatible with the cutout dimensions and power connection features of the older model. All information subject to change without notice.

4/18/2024



Thermal Edge Inc.TM

TEMPERATURE CONTROL SOLUTIONS FOR ELECTRICAL ENCLOSURES

50 HZ HAZARDOUS LOCATIONS ENCLOSURE AIR CONDITIONERS

Fully Integrated Condensate Evaporation Package
Programmable Digital Controller
Thermal Expansion Valve
Energy Efficient - Low Running Amps



MADE IN AMERICA MATTERS...



AIR CONDITIONER PRODUCT LINE (J4)

Thermal Edge 50 Hz Hazardous Location air conditioners are certified to the following standard(s): ANSI/ISA-12.12.01-2015 Nonincendive Electrical Equipment for use in Class I, Division 2, Groups A, B, C and D Hazardous (Classified) Locations; CAN/CSA C22.2 No. 213-15 Nonincendive Electrical Equipment for use in Class I, Division 2, Groups A, B, C and D Hazardous (Classified) Locations.

Model	BTU/Hour	Voltage/ Phase/Hz	Maximum Ambient Temp	Temp. Code
CS020235	2,000	230/1/50	48°C	T6
NE020105	2,000	100/1/50	50°C	T4
NE020235	2,000	230/1/50	50°C	T4
NE020385	2,000	380/1/50	50°C	T4
NE020405	2,000	400/1/50	50°C	T4
NE020415	2,000	415/1/50	50°C	T4
NE030105	3,000	100/1/50	50°C	T4
NE030205	3,000	200/1/50	50°C	T4
NE030385	3,000	380/1/50	50°C	T4
NE030405	3,000	400/1/50	50°C	T4
NE030415	3,000	415/1/50	50°C	T4
NE050235	5,000	230/1/50	50°C	T4
NE050385	5,000	380/1/50	50°C	T4
NE050405	5,000	400/1/50	50°C	T4
NE050415	5,000	415/1/50	50°C	T4
NE060235	6,000	230/1/50	50°C	T4
NE060385	6,000	380/1/50	50°C	T4
NE060405	6,000	400/1/50	50°C	T4
NE060415	6,000	415/1/50	50°C	T4
HC080235	8,000	230/1/50	50°C	T4
HC080385	8,000	380/1/50	50°C	T4
HC080405	8,000	400/1/50	50°C	T4
HC080415	8,000	415/1/50	50°C	T4
HC101235	10,000	230/1/50	50°C	T4
HC101385	10,000	380/1/50	50°C	T4
HC101405	10,000	400/1/50	50°C	T4
HC101415	10,000	415/1/50	50°C	T4
HC121235	12,000	230/1/50	50°C	T4
HC121385	12,000	380/1/50	50°C	T4
HC121405	12,000	400/1/50	50°C	T4
HC121415	12,000	415/1/50	50°C	T4

CS020J4 (50 HZ)

HAZARDOUS LOCATIONS

2000 BTUH | INDOOR/OUTDOOR, UL TYPES 12, 4 & 4X AVAILABLE

Designed to provide nonincendive cooling for electrical enclosures in hazardous locations, these closed-loop units are ideal for use on systems in chemical and petrochemical, refining, onshore and offshore drilling applications.



Thermal Edge CS020J4 50Hz Hazardous Location air conditioners are certified to the following standard(s): *

- ANSI/ISA-12.12.01-2015 Nonincendive Electrical Equipment for use in Class I, Division 2, Groups A, B, C, and D Hazardous (Classified) Locations
- CAN/CSA C22.2 No. 213-15 Nonincendive Electrical Equipment for use in Class I, Division 2, Groups A, B, C, and D Hazardous (Classified) Locations
- $0^{\circ}\text{C} \leq T_a \leq +48^{\circ}\text{C}$

System Features

- For purged and non-purged enclosures
- Active, energy efficient, Condensate Evaporation System
- Fully programmable digital controller with built in alarms and alerts
- Remote controller option places controller inside enclosure
- Thermal Expansion Valve for maximum efficiency when temperature or heat load changes
- Hermetically sealed compressor thermal overload protector
- 2000 BTUH
- Narrow body style fits on 10" enclosure
- Available in UL types 12, 4 and 4X

Unit Efficiency

- Highly efficient Rotary Compressor
- Fully insulated & sealed cabinet

OPTIONS:

- Corrosion Protection
- Low Ambient
- Remote Controller
- Dry Contact
- Controller Programming
- External Heater Control (for Haz Loc enclosure heaters)
- Filter/Filter Frame
- Extended Temp. Probe
- Custom Finish

Model	UL Type	BTU/Hour	Material	Voltage/Phase/Hz.	Running Amps	Max. Amb. Temp.	H x W x D	Weight (lbs.) Unit/Ship
CS02023512J4	12	2,000	Powder coated steel	207-253/1/50	1.7	48°C	20" x 10" x 10"	49 / 63
CS02023504J4	4	2,000	Powder coated steel	207-253/1/50	1.7	48°C	20" x 10" x 10"	49 / 63
CS0202354XJ4	4X	2,000	Stainless steel	207-253/1/50	1.7	48°C	20" x 10" x 10"	49 / 63

Testing done under controlled conditions. Actual performance may vary.

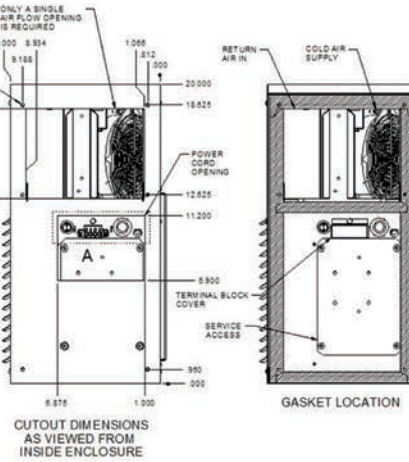
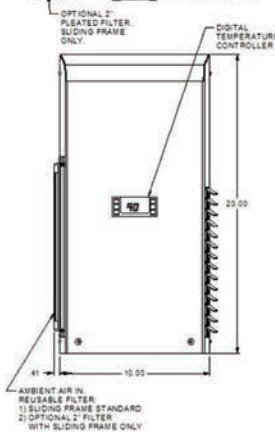
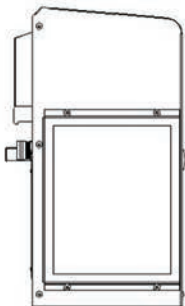
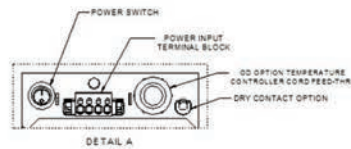
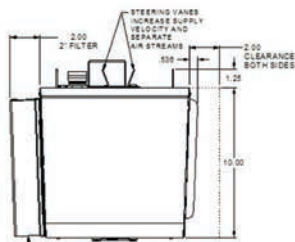
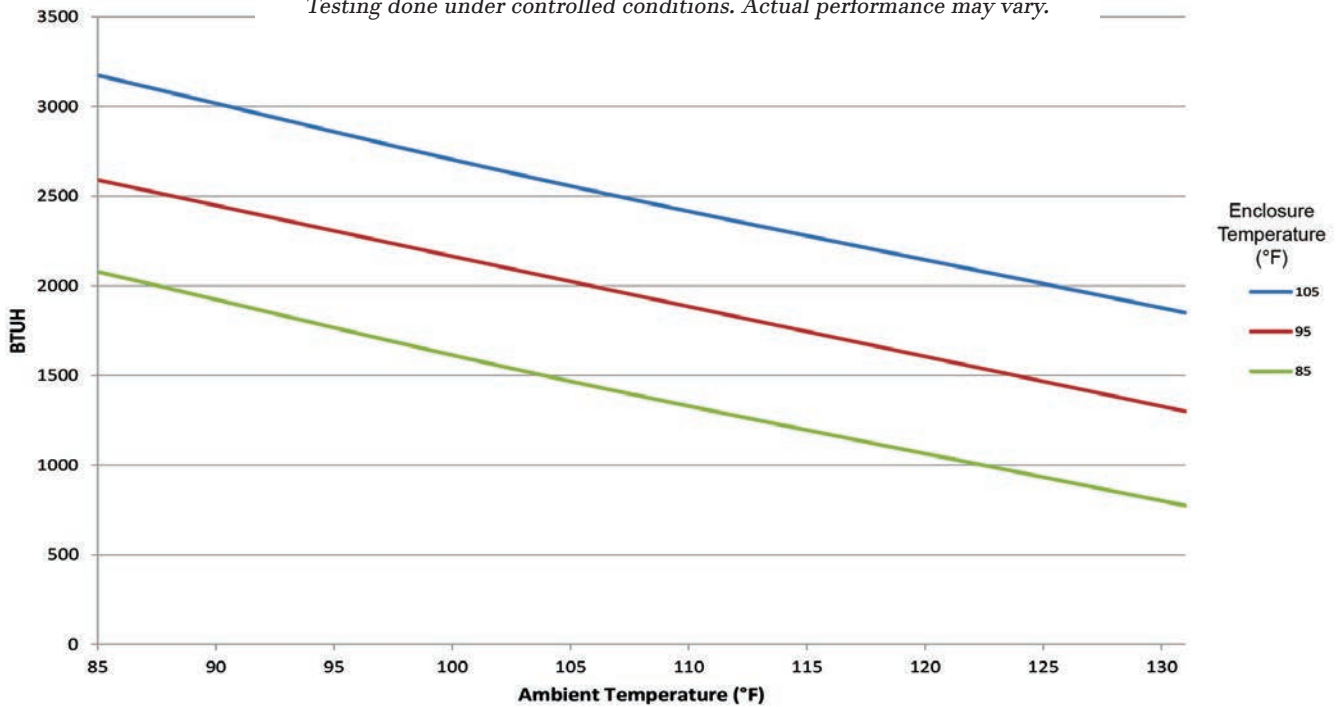

*Critical components in the NRTL Hazardous Location Listing Report must not be substituted with alternate components. Thermal Edge, Inc. and MET Labs must be notified before changes to any drawings, samples, or required documentation are approved.

ATTENTION: If ordering a replacement for a Thermal Edge air conditioner, please include the part number and serial number of the unit being replaced in your order. This will ensure that we ship a replacement that is compatible with the cutout dimensions and power connection features of the older model. All information subject to change without notice.

HAZARDOUS LOCATIONS

2000 BTUH | INDOOR/OUTDOOR, UL TYPES 12, 4 & 4X AVAILABLE

Designed to provide nonincendive cooling for electrical enclosures in hazardous locations, these closed-loop units are ideal for use on systems in chemical and petrochemical, refining, onshore and offshore drilling applications.



Thermal Edge NE020J4 50Hz Hazardous Location air conditioners are certified to the following standard(s):*

- ANSI/ISA-12.12.01-2015 Nonincendive Electrical Equipment for use in Class I, Division 2, Groups A, B, C, and D T4 Hazardous (Classified) Locations
- CAN/CSA C22.2 No. 213-15 Nonincendive Electrical Equipment for use in Class I, Division 2, Groups A, B, C, and D T4 Hazardous (Classified) Locations
- $0^{\circ}\text{C} \leq T_a \leq +50^{\circ}\text{C}$

System Features

- For purged and non-purged enclosures
- Active, energy efficient, Condensate Evaporation System
- Fully programmable digital controller with built in alarms and alerts
- Remote controller option places controller inside enclosure
- Thermal Expansion Valve for maximum efficiency when temperature or heat load changes
- Hermetically sealed compressor thermal overload protector
- 2000 BTUH
- Narrow body style fits on 12" enclosure
- Available in UL types 12, 4 and 4X

Unit Efficiency

- Pressure-operated condenser fan reduces power inrush and saves energy
- Highly efficient Rotary Compressor
- Fully insulated & sealed cabinet

OPTIONS:

- Corrosion Protection
- Low Ambient
- Remote Controller
- Dry Contact
- Controller Programming
- External Heater Control (for Haz Loc enclosure heaters)
- Filter/Filter Frame
- Extended Temp. Probe
- Vibration Resistant
- Custom Finish

Model	UL Type	BTU/Hour	Material	Voltage/Phase/Hz.	Running Amps	Max. Amb. Temp.	H x W x D	Weight (lbs.) Unit/Ship
NE02010512J4	12	2,000	Powder coated steel	100/1/50	5.2	50°C	32" x 11.8" x 9.5"	65 / 79
NE02010504J4	4	2,000	Powder coated steel	100/1/50	5.2	50°C	32" x 11.8" x 9.5"	65 / 79
NE0201054XJ4	4X	2,000	Stainless steel	100/1/50	5.2	50°C	32" x 11.8" x 9.5"	65 / 79
NE02023512J4	12	2,000	Powder coated steel	230/1/50	1.7	50°C	32" x 11.8" x 9.5"	65 / 79
NE02023504J4	4	2,000	Powder coated steel	230/1/50	1.7	50°C	32" x 11.8" x 9.5"	65 / 79
NE0202354XJ4	4X	2,000	Stainless steel	230/1/50	1.7	50°C	32" x 11.8" x 9.5"	65 / 79
NE02038512J4	12	2,000	Powder coated steel	380/1/50	1.4	50°C	38" x 11.8" x 9.5"	99 / 113
NE02038504J4	4	2,000	Powder coated steel	380/1/50	1.4	50°C	38" x 11.8" x 9.5"	99 / 113
NE0203854XJ4	4X	2,000	Stainless steel	380/1/50	1.4	50°C	38" x 11.8" x 9.5"	99 / 113

Testing done under controlled conditions. Actual performance may vary.

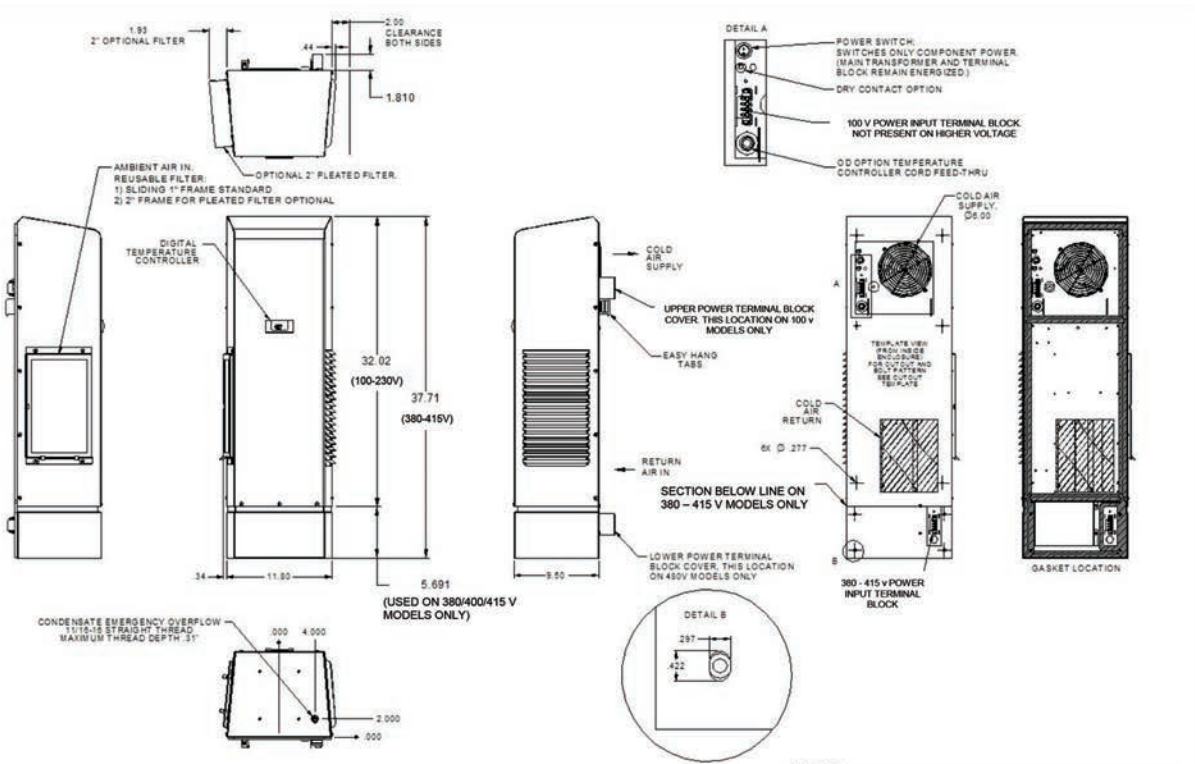
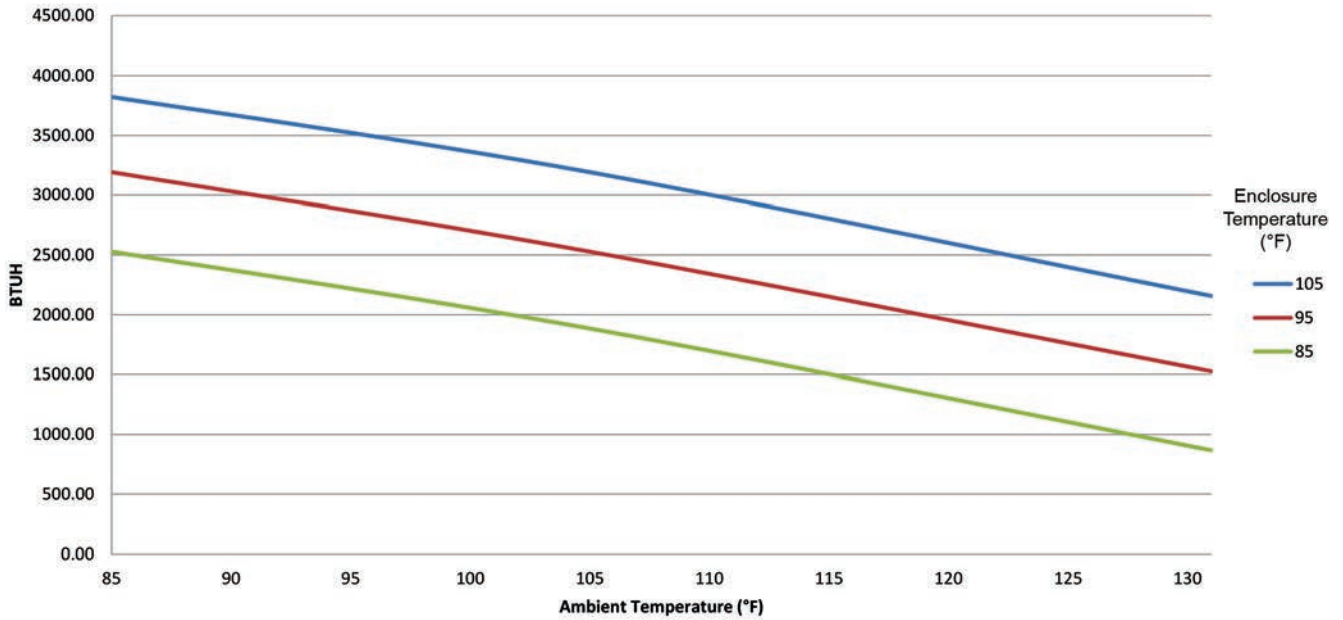



 NRTL LISTED

 E113961

 Haz Loc

 Certification



 SA32252

 Ord Loc

 Certification





*Critical components in the NRTL Hazardous Location Listing Report must not be substituted with alternate components. Thermal Edge, Inc. and MET Labs must be notified before changes to any drawings, samples, or required documentation are approved.

ATTENTION: If ordering a replacement for a Thermal Edge air conditioner, please include the part number and serial number of the unit being replaced in your order. This will ensure that we ship a replacement that is compatible with the cutout dimensions and power connection features of the older model. All information subject to change without notice.

HAZARDOUS LOCATIONS

3000 BTUH | INDOOR/OUTDOOR, UL TYPES 12, 4 & 4X AVAILABLE

Designed to provide nonincendive cooling for electrical enclosures in hazardous locations, these closed-loop units are ideal for use on systems in chemical and petrochemical, refining, onshore and offshore drilling applications.



Thermal Edge NE030J4 50Hz Hazardous Location air conditioners are certified to the following standard(s):*

- ANSI/ISA-12.12.01-2015 Nonincendive Electrical Equipment for use in Class I, Division 2, Groups A, B, C, and D T4 Hazardous (Classified) Locations
- CAN/CSA C22.2 No. 213-15 Nonincendive Electrical Equipment for use in Class I, Division 2, Groups A, B, C, and D T4 Hazardous (Classified) Locations
- $0^{\circ}\text{C} \leq T_a \leq +50^{\circ}\text{C}$

System Features

- For purged and non-purged enclosures
- Active, energy efficient, Condensate Evaporation System
- Fully programmable digital controller with built in alarms and alerts
- Remote controller option places controller inside enclosure
- Thermal Expansion Valve for maximum efficiency when temperature or heat load changes
- Hermetically sealed compressor thermal overload protector
- 3000 BTUH
- Narrow body style fits on 12" enclosure
- Available in UL types 12, 4 and 4X

Unit Efficiency

- Pressure-operated condenser fan reduces power inrush and saves energy
- Highly efficient Rotary Compressor
- Fully insulated & sealed cabinet

OPTIONS:

- Corrosion Protection
- Low Ambient
- Remote Controller
- Dry Contact
- Controller Programming
- External Heater Control (for Haz Loc enclosure heaters)
- Filter/Filter Frame
- Extended Temp. Probe
- Vibration Resistant
- Custom Finish

Model	UL Type	BTU/Hour	Material	Voltage/Phase/Hz.	Running Amps	Max. Amb. Temp.	H x W x D	Weight (lbs.) Unit/Ship
NE03010512J4	12	3,000	Powder coated steel	100/1/50	5	50°C	32" x 11.8" x 9.5"	66 / 80
NE03010504J4	4	3,000	Powder coated steel	100/1/50	5	50°C	32" x 11.8" x 9.5"	66 / 80
NE0301054XJ4	4X	3,000	Stainless steel	100/1/50	5	50°C	32" x 11.8" x 9.5"	66 / 80
NE03020512J4	12	3,000	Powder coated steel	200/1/50	3.07	50°C	38" x 11.8" x 9.5"	99 / 113
NE03020504J4	4	3,000	Powder coated steel	200/1/50	3.07	50°C	38" x 11.8" x 9.5"	99 / 113
NE0302054XJ4	4X	3,000	Stainless steel	200/1/50	3.07	50°C	38" x 11.8" x 9.5"	99 / 113
NE03038512J4	12	3,000	Powder coated steel	380/1/50	1.32	50°C	38" x 11.8" x 9.5"	99 / 113
NE03038504J4	4	3,000	Powder coated steel	380/1/50	1.32	50°C	38" x 11.8" x 9.5"	99 / 113
NE0303854XJ4	4X	3,000	Stainless steel	380/1/50	1.32	50°C	38" x 11.8" x 9.5"	99 / 113

Testing done under controlled conditions. Actual performance may vary.

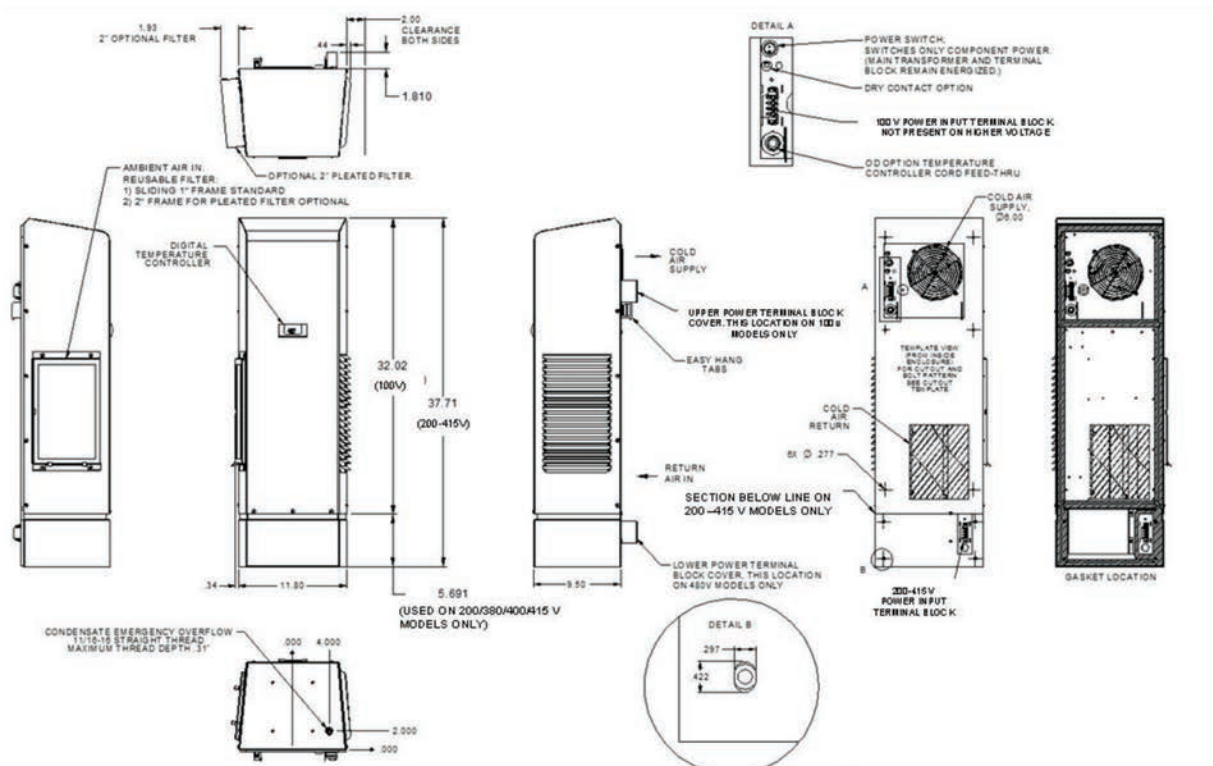
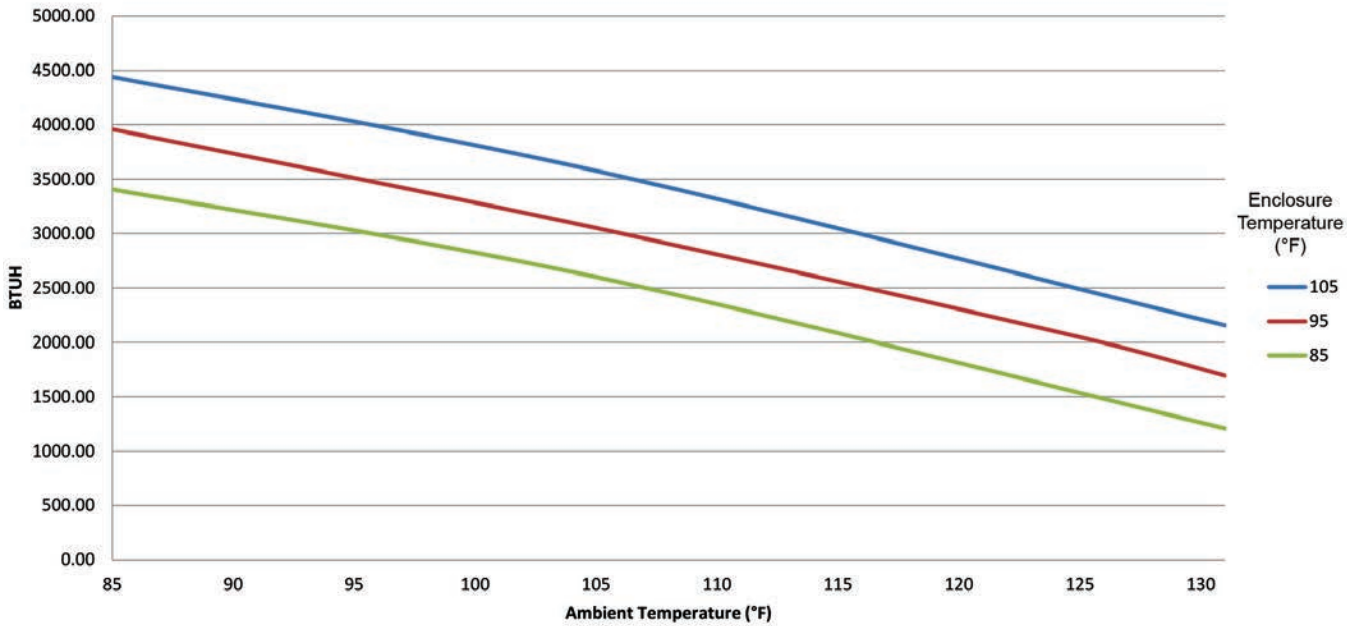

MET NRTL LISTED
 E113961
 Haz Loc
 Certification

UL SA32252
 Ord Loc
 Certification

CE

5-YEAR WARRANTY
 Thermal Edge Inc.

*Critical components in the NRTL Hazardous Location Listing Report must not be substituted with alternate components. Thermal Edge, Inc. and MET Labs must be notified before changes to any drawings, samples, or required documentation are approved.

ATTENTION: If ordering a replacement for a Thermal Edge air conditioner, please include the part number and serial number of the unit being replaced in your order. This will ensure that we ship a replacement that is compatible with the cutout dimensions and power connection features of the older model. All information subject to change without notice.

HAZARDOUS LOCATIONS

5000 BTUH | INDOOR/OUTDOOR, UL TYPES 12, 4 & 4X AVAILABLE

Designed to provide nonincendive cooling for electrical enclosures in hazardous locations, these closed-loop units are ideal for use on systems in chemical and petrochemical, refining, onshore and offshore drilling applications.



OPTIONS:

- Corrosion Protection
- Low Ambient
- Remote Controller
- Dry Contact
- Controller Programming
- External Heater Control
(for Haz Loc enclosure heaters)
- Filter/Filter Frame
- Extended Temp. Probe
- Vibration Resistant
- Custom Finish

Thermal Edge NE050J4 50Hz Hazardous Location air conditioners are certified to the following standard(s):*

- ANSI/ISA-12.12.01-2015 Nonincendive Electrical Equipment for use in Class I, Division 2, Groups A, B, C, and D T4 Hazardous (Classified) Locations
- CAN/CSA C22.2 No. 213-15 Nonincendive Electrical Equipment for use in Class I, Division 2, Groups A, B, C, and D T4 Hazardous (Classified) Locations
- $0^{\circ}\text{C} \leq T_a \leq +50^{\circ}\text{C}$

System Features

- For purged and non-purged enclosures
- Active, energy efficient, Condensate Evaporation System
- Fully programmable digital controller with built in alarms and alerts
- Remote controller option places controller inside enclosure
- Thermal Expansion Valve for maximum efficiency when temperature or heat load changes
- Hermetically sealed compressor thermal overload protector
- 5000 BTUH
- Narrow body style fits on 12" enclosure
- Available in UL types 12, 4 and 4X

Unit Efficiency

- Pressure-operated condenser fan reduces power inrush and saves energy
- Highly efficient Rotary Compressor
- Fully insulated & sealed cabinet

Model	UL Type	BTU/Hour	Material	Voltage/Phase/Hz.	Running Amps	Max. Amb. Temp.	H x W x D	Weight (lbs.) Unit/Ship
NE05023512J4	12	5,000	Powder coated steel	230/1/50	3.1	50°C	36" x 11.8" x 15.02"	92 / 106
NE05023504J4	4	5,000	Powder coated steel	230/1/50	3.1	50°C	36" x 11.8" x 15.02"	92 / 106
NE0502354XJ4	4X	5,000	Stainless steel	230/1/50	3.1	50°C	36" x 11.8" x 15.02"	92 / 106
NE05038512J4	12	5,000	Powder coated steel	380/1/50	2.1	50°C	44.63" x 11.8" x 15.02"	136 / 150
NE05038504J4	4	5,000	Powder coated steel	380/1/50	2.1	50°C	44.63" x 11.8" x 15.02"	136 / 150
NE0503854XJ4	4X	5,000	Stainless steel	380/1/50	2.1	50°C	44.63" x 11.8" x 15.02"	136 / 150
NE05040512J4	12	5,000	Powder coated steel	400/1/50	1.9	50°C	44.63" x 11.8" x 15.02"	136 / 150
NE05040504J4	4	5,000	Powder coated steel	400/1/50	1.9	50°C	44.63" x 11.8" x 15.02"	136 / 150
NE0504054XJ4	4X	5,000	Stainless steel	400/1/50	1.9	50°C	44.63" x 11.8" x 15.02"	136 / 150

Testing done under controlled conditions. Actual performance may vary.

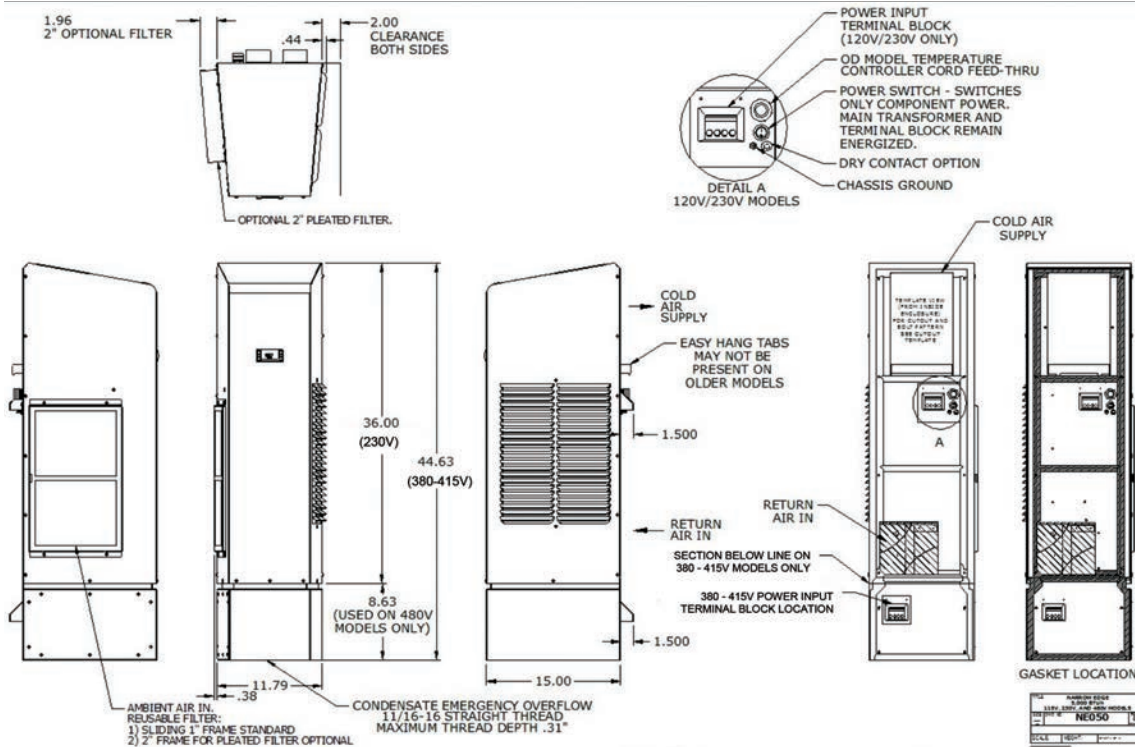
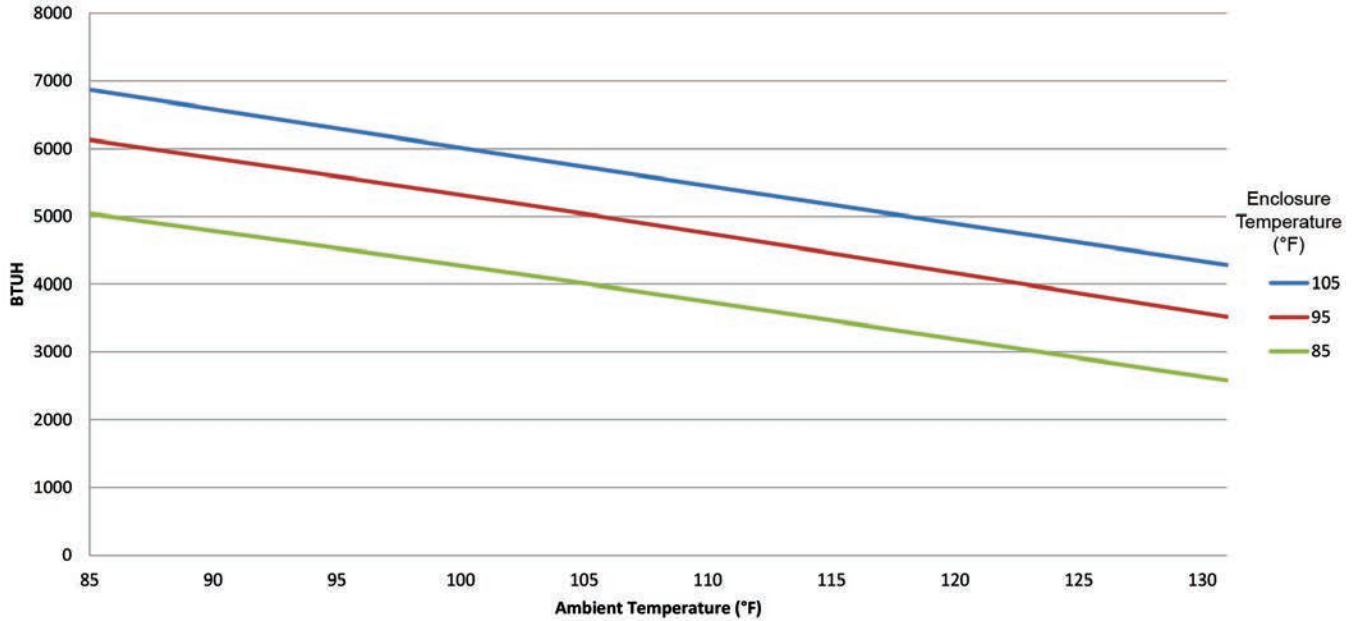

*Critical components in the NRTL Hazardous Location Listing Report must not be substituted with alternate components. Thermal Edge, Inc. and MET Labs must be notified before changes to any drawings, samples, or required documentation are approved.

ATTENTION: If ordering a replacement for a Thermal Edge air conditioner, please include the part number and serial number of the unit being replaced in your order. This will ensure that we ship a replacement that is compatible with the cutout dimensions and power connection features of the older model. All information subject to change without notice.

HAZARDOUS LOCATIONS

6000 BTUH | INDOOR/OUTDOOR, UL TYPES 12, 4 & 4X AVAILABLE

Designed to provide nonincendive cooling for electrical enclosures in hazardous locations, these closed-loop units are ideal for use on systems in chemical and petrochemical, refining, onshore and offshore drilling applications.



OPTIONS:

- Corrosion Protection
- Low Ambient
- Remote Controller
- Dry Contact
- Controller Programming
- External Heater Control
(for Haz Loc enclosure heaters)
- Filter/Filter Frame
- Extended Temp. Probe
- Vibration Resistant
- Custom Finish

Thermal Edge NE060J4 50Hz Hazardous Location air conditioners are certified to the following standard(s):*

- ANSI/ISA-12.12.01-2015 Nonincendive Electrical Equipment for use in Class I, Division 2, Groups A, B, C, and D T4 Hazardous (Classified) Locations
- CAN/CSA C22.2 No. 213-15 Nonincendive Electrical Equipment for use in Class I, Division 2, Groups A, B, C, and D T4 Hazardous (Classified) Locations
- $0^{\circ}\text{C} \leq T_a \leq +50^{\circ}\text{C}$

System Features

- For purged and non-purged enclosures
- Active, energy efficient, Condensate Evaporation System
- Fully programmable digital controller with built in alarms and alerts
- Remote controller option places controller inside enclosure
- Thermal Expansion Valve for maximum efficiency when temperature or heat load changes
- Hermetically sealed compressor thermal overload protector
- 6000 BTUH
- Narrow body style fits on 12" enclosure
- Available in UL types 12, 4 and 4X

Unit Efficiency

- Pressure-operated condenser fan reduces power inrush and saves energy
- Highly efficient Rotary Compressor
- Fully insulated & sealed cabinet

Model	UL Type	BTU/Hour	Material	Voltage/Phase/Hz.	Running Amps	Max. Amb. Temp.	H x W x D	Weight (lbs.) Unit/Ship
NE06023512J4	12	6,000	Powder coated steel	230/1/50	3.99	50°C	36" x 11.8" x 15.02"	98 / 112
NE06023504J4	4	6,000	Powder coated steel	230/1/50	3.99	50°C	36" x 11.8" x 15.02"	98 / 112
NE0602354XJ4	4X	6,000	Stainless steel	230/1/50	3.99	50°C	36" x 11.8" x 15.02"	98 / 112
NE06038512J4	12	6,000	Powder coated steel	380/1/50	2.4	50°C	44.63" x 11.8" x 15.02"	142 / 156
NE06038504J4	4	6,000	Powder coated steel	380/1/50	2.4	50°C	44.63" x 11.8" x 15.02"	142 / 156
NE0603854XJ4	4X	6,000	Stainless steel	380/1/50	2.4	50°C	44.63" x 11.8" x 15.02"	142 / 156
NE06040512J4	12	6,000	Powder coated steel	400/1/50	2.3	50°C	44.63" x 11.8" x 15.02"	142 / 156
NE06040504J4	4	6,000	Powder coated steel	400/1/50	2.3	50°C	44.63" x 11.8" x 15.02"	142 / 156
NE0604054XJ4	4X	6,000	Stainless steel	400/1/50	2.3	50°C	44.63" x 11.8" x 15.02"	142 / 156

Testing done under controlled conditions. Actual performance may vary.

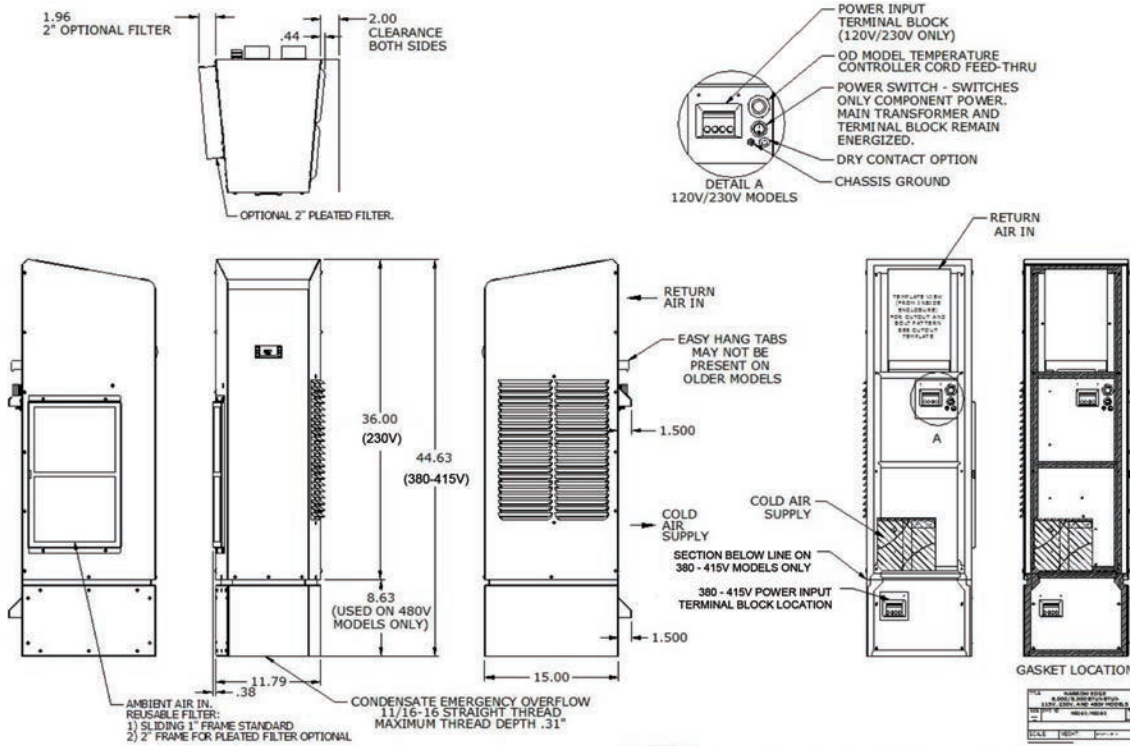
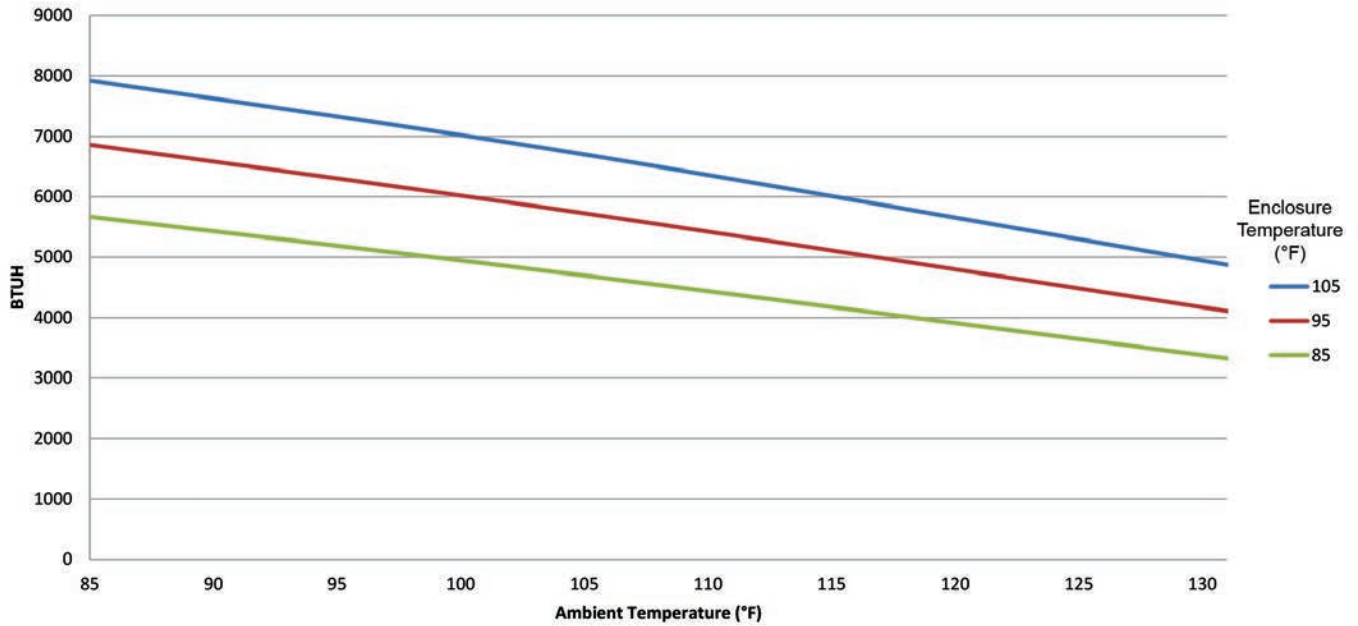

*Critical components in the NRTL Hazardous Location Listing Report must not be substituted with alternate components. Thermal Edge, Inc. and MET Labs must be notified before changes to any drawings, samples, or required documentation are approved.

ATTENTION: If ordering a replacement for a Thermal Edge air conditioner, please include the part number and serial number of the unit being replaced in your order. This will ensure that we ship a replacement that is compatible with the cutout dimensions and power connection features of the older model. All information subject to change without notice.

HAZARDOUS LOCATIONS

8000 BTUH | INDOOR/OUTDOOR, UL TYPES 12, 4 & 4X AVAILABLE

Designed to provide nonincendive cooling for electrical enclosures in hazardous locations, these closed-loop units are ideal for use on systems in chemical and petrochemical, refining, onshore and offshore drilling applications.



OPTIONS:

- Corrosion Protection
- Low Ambient
- Remote Controller
- Dry Contact
- Controller Programming
- External Heater Control (for Haz Loc enclosure heaters)
- Filter/Filter Frame
- Extended Temp. Probe
- Custom Finish

Thermal Edge HC080J4 50Hz Hazardous Location air conditioners are certified to the following standard(s):*

- ANSI/ISA-12.12.01-2015 Nonincendive Electrical Equipment for use in Class I, Division 2, Groups A, B, C, and D T4 Hazardous (Classified) Locations
- CAN/CSA C22.2 No. 213-15 Nonincendive Electrical Equipment for use in Class I, Division 2, Groups A, B, C, and D T4 Hazardous (Classified) Locations
- $0^{\circ}\text{C} \leq T_a \leq +50^{\circ}\text{C}$

System Features

- For purged and non-purged enclosures
- Active, energy efficient, Condensate Evaporation System
- Fully programmable digital controller with built in alarms and alerts
- Remote controller option places controller inside enclosure
- Thermal Expansion Valve for maximum efficiency when temperature or heat load changes
- Hermetically sealed compressor thermal overload protector
- 8000 BTUH
- Available in UL types 12, 4 and 4X

Unit Efficiency

- Pressure-operated condenser fan reduces power inrush and saves energy
- Highly efficient Rotary Compressor
- Fully insulated & sealed cabinet

Model	UL Type	BTU/Hour	Material	Voltage/Phase/Hz.	Running Amps	Max. Amb. Temp.	H x W x D	Weight (lbs.) Unit/Ship
HC08023512J4	12	8,000	Powder coated steel	230/1/50	7.1	50°C	48" x 15.86" x 15"	166 / 186
HC08023504J4	4	8,000	Powder coated steel	230/1/50	7.1	50°C	48" x 15.86" x 15"	166 / 186
HC0802354XJ4	4X	8,000	Stainless steel	230/1/50	7.1	50°C	48" x 15.86" x 15"	166 / 186
HC08038512J4	12	8,000	Powder coated steel	380/1/50	4.3	50°C	57.6" x 15.86" x 15"	232 / 275
HC08038504J4	4	8,000	Powder coated steel	380/1/50	4.3	50°C	57.6" x 15.86" x 15"	232 / 275
HC0803854XJ4	4X	8,000	Stainless steel	380/1/50	4.3	50°C	57.6" x 15.86" x 15"	232 / 275
HC08040512J4	12	8,000	Powder coated steel	400/1/50	4.1	50°C	57.6" x 15.86" x 15"	232 / 275
HC08040504J4	4	8,000	Powder coated steel	400/1/50	4.1	50°C	57.6" x 15.86" x 15"	232 / 275
HC0804054XJ4	4X	8,000	Stainless steel	400/1/50	4.1	50°C	57.6" x 15.86" x 15"	232 / 275

Testing done under controlled conditions. Actual performance may vary.

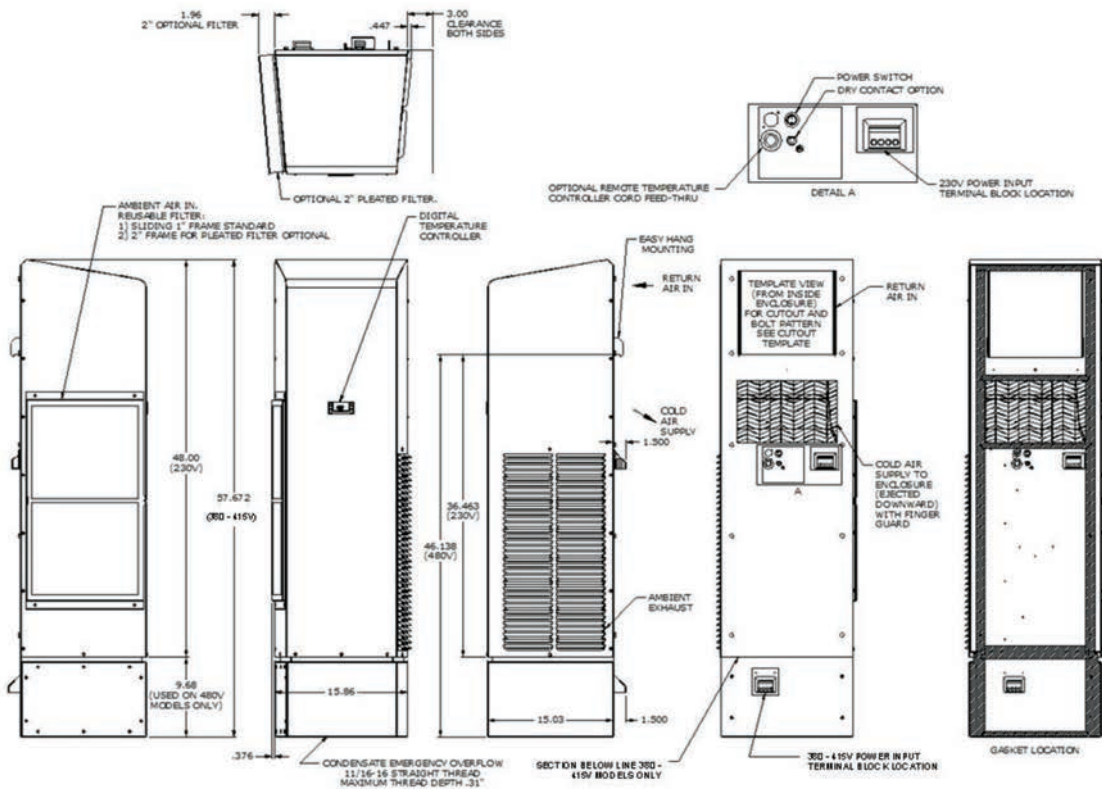
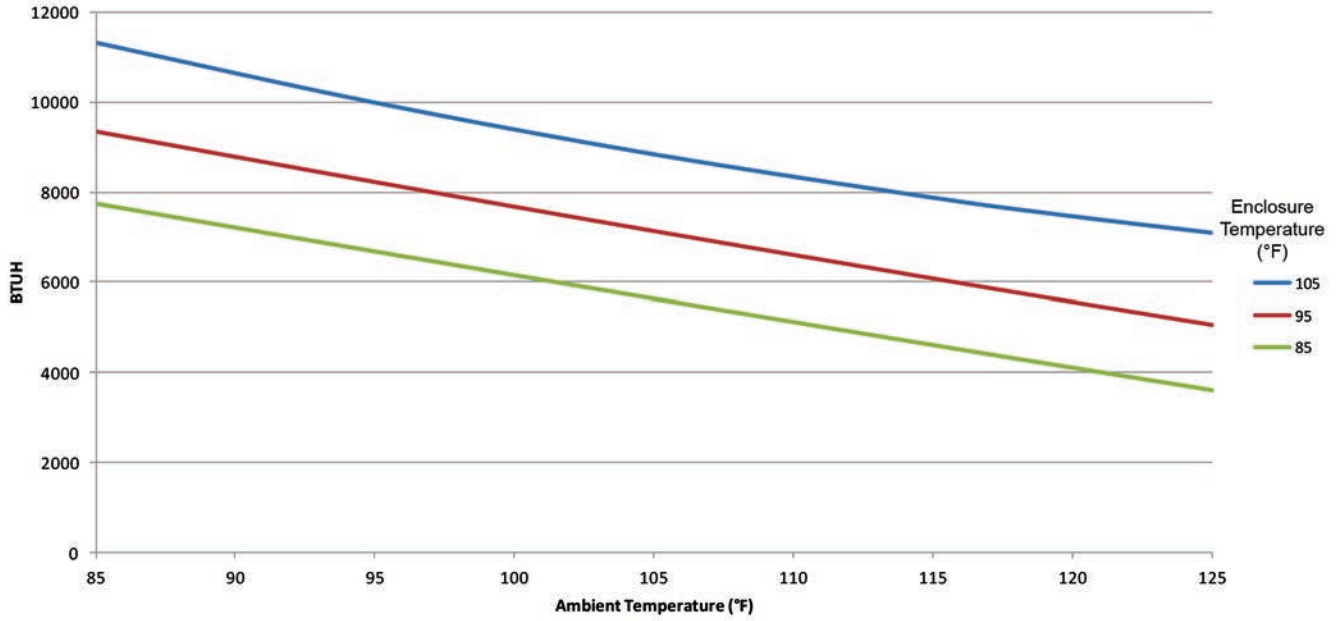

*Critical components in the NRTL Hazardous Location Listing Report must not be substituted with alternate components. Thermal Edge, Inc. and MET Labs must be notified before changes to any drawings, samples, or required documentation are approved.

ATTENTION: If ordering a replacement for a Thermal Edge air conditioner, please include the part number and serial number of the unit being replaced in your order. This will ensure that we ship a replacement that is compatible with the cutout dimensions and power connection features of the older model. All information subject to change without notice.

HC101J4 (50 HZ)

HAZARDOUS LOCATIONS

10,000 BTUH | INDOOR/OUTDOOR, UL TYPES 12, 4 & 4X AVAILABLE

Designed to provide nonincendive cooling for electrical enclosures in hazardous locations, these closed-loop units are ideal for use on systems in chemical and petrochemical, refining, onshore and offshore drilling applications.



OPTIONS:

- Corrosion Protection
- Low Ambient
- Remote Controller
- Dry Contact
- Controller Programming
- External Heater Control
(for Haz Loc enclosure heaters)
- Filter/Filter Frame
- Extended Temp. Probe
- Custom Finish

Thermal Edge HC101J4 50Hz Hazardous Location air conditioners are certified to the following standard(s):*

- ANSI/ISA-12.12.01-2015 Nonincendive Electrical Equipment for use in Class I, Division 2, Groups A, B, C, and D T4 Hazardous (Classified) Locations
- CAN/CSA C22.2 No. 213-15 Nonincendive Electrical Equipment for use in Class I, Division 2, Groups A, B, C, and D T4 Hazardous (Classified) Locations
- $0^{\circ}\text{C} \leq T_a \leq +50^{\circ}\text{C}$

System Features

- For purged and non-purged enclosures
- Active, energy efficient, Condensate Evaporation System
- Fully programmable digital controller with built in alarms and alerts
- Remote controller option places controller inside enclosure
- Thermal Expansion Valve for maximum efficiency when temperature or heat load changes
- Hermetically sealed compressor thermal overload protector
- 10,000 BTUH
- Available in UL types 12, 4 and 4X

Unit Efficiency

- Pressure-operated condenser fan reduces power inrush and saves energy
- Highly efficient Rotary Compressor
- Fully insulated & sealed cabinet

Model	UL Type	BTU/Hour	Material	Voltage/Phase/Hz.	Running Amps	Max. Amb. Temp.	H x W x D	Weight (lbs.) Unit/Ship
HC10123512J4	12	10,000	Powder coated steel	230/1/50	6.4	50°C	48" x 15.86" x 15"	166 / 186
HC10123504J4	4	10,000	Powder coated steel	230/1/50	6.4	50°C	48" x 15.86" x 15"	166 / 186
HC1012354XJ4	4X	10,000	Stainless steel	230/1/50	6.4	50°C	48" x 15.86" x 15"	166 / 186
HC10138512J4	12	10,000	Powder coated steel	380/1/50	3.9	50°C	57.6" x 15.86" x 15"	232 / 275
HC10138504J4	4	10,000	Powder coated steel	380/1/50	3.9	50°C	57.6" x 15.86" x 15"	232 / 275
HC1013854XJ4	4X	10,000	Stainless steel	380/1/50	3.9	50°C	57.6" x 15.86" x 15"	232 / 275
HC10140512J4	12	10,000	Powder coated steel	400/1/50	3.7	50°C	57.6" x 15.86" x 15"	232 / 275
HC10140504J4	4	10,000	Powder coated steel	400/1/50	3.7	50°C	57.6" x 15.86" x 15"	232 / 275
HC1014054XJ4	4X	10,000	Stainless steel	400/1/50	3.7	50°C	57.6" x 15.86" x 15"	232 / 275

Testing done under controlled conditions. Actual performance may vary.

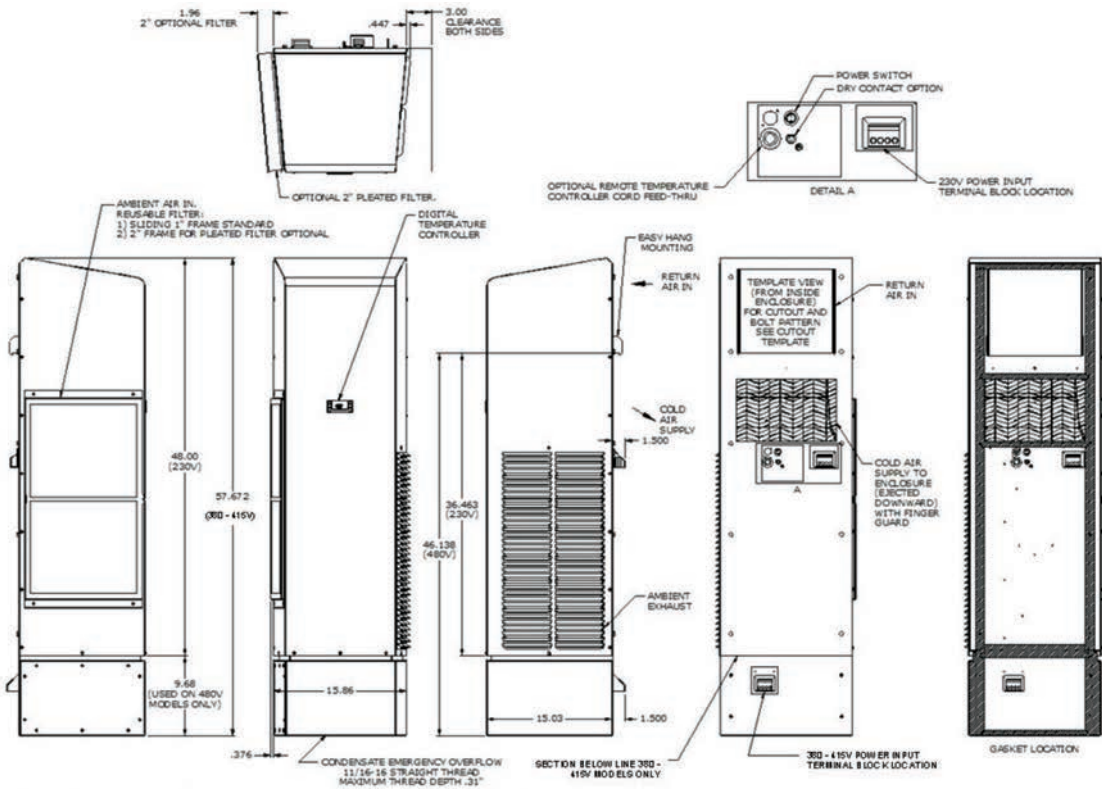
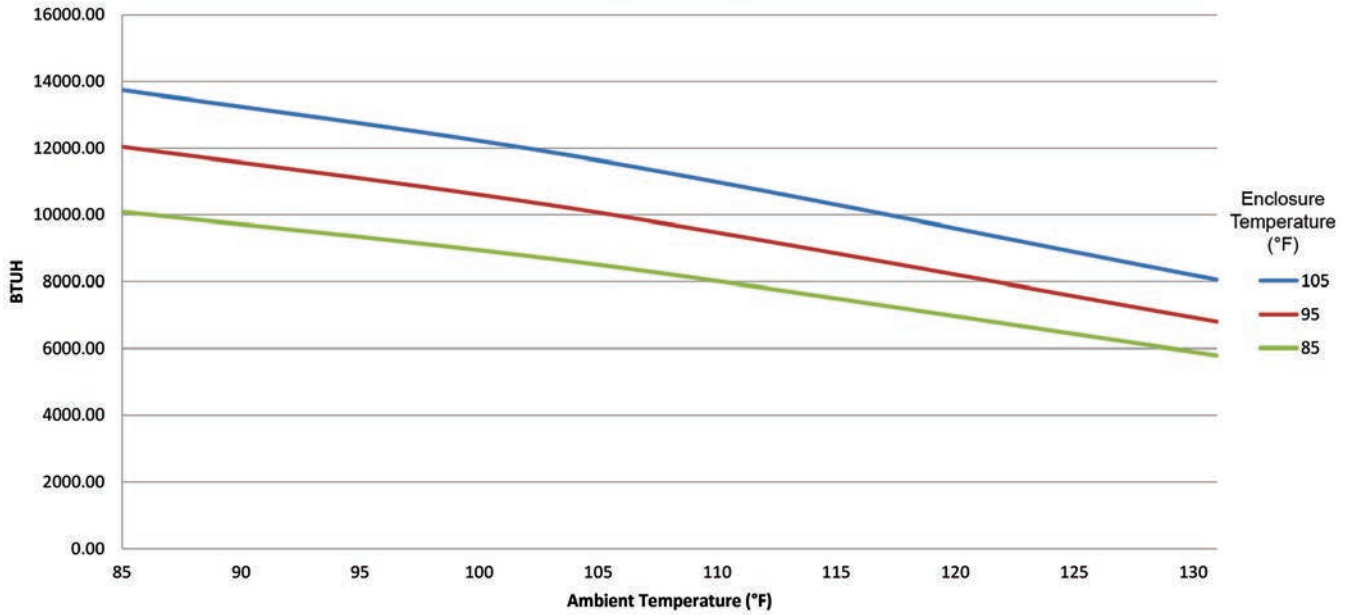

*Critical components in the NRTL Hazardous Location Listing Report must not be substituted with alternate components. Thermal Edge, Inc. and MET Labs must be notified before changes to any drawings, samples, or required documentation are approved.

ATTENTION: If ordering a replacement for a Thermal Edge air conditioner, please include the part number and serial number of the unit being replaced in your order. This will ensure that we ship a replacement that is compatible with the cutout dimensions and power connection features of the older model. All information subject to change without notice.

HAZARDOUS LOCATIONS

12,000 BTUH | INDOOR/OUTDOOR, UL TYPES 12, 4 & 4X AVAILABLE

Designed to provide nonincendive cooling for electrical enclosures in hazardous locations, these closed-loop units are ideal for use on systems in chemical and petrochemical, refining, onshore and offshore drilling applications.



Thermal Edge HC121J4 50Hz Hazardous Location air conditioners are certified to the following standard(s):*

- ANSI/ISA-12.12.01-2015 Nonincendive Electrical Equipment for use in Class I, Division 2, Groups A, B, C, and D T4 Hazardous (Classified) Locations
- CAN/CSA C22.2 No. 213-15 Nonincendive Electrical Equipment for use in Class I, Division 2, Groups A, B, C, and D T4 Hazardous (Classified) Locations
- $0^{\circ}\text{C} \leq T_a \leq +50^{\circ}\text{C}$

System Features

- For purged and non-purged enclosures
- Active, energy efficient, Condensate Evaporation System
- Fully programmable digital controller with built in alarms and alerts
- Remote controller option places controller inside enclosure
- Thermal Expansion Valve for maximum efficiency when temperature or heat load changes
- Hermetically sealed compressor thermal overload protector
- 12,000 BTUH
- Available in UL types 12, 4 and 4X

Unit Efficiency

- Pressure-operated condenser fan reduces power inrush and saves energy
- Highly efficient Rotary Compressor
- Fully insulated & sealed cabinet

OPTIONS:

- Corrosion Protection
- Low Ambient
- Remote Controller
- Dry Contact
- Controller Programming
- External Heater Control (for Haz Loc enclosure heaters)
- Filter/Filter Frame
- Extended Temp. Probe
- Custom Finish

Model	UL Type	BTU/Hour	Material	Voltage/Phase/Hz.	Running Amps	Max. Amb. Temp.	H x W x D	Weight (lbs.) Unit/Ship
HC12123512J4	12	12,000	Powder coated steel	230/1/50	8.2	50°C	48" x 15.86" x 15"	163 / 183
HC12123504J4	4	12,000	Powder coated steel	230/1/50	8.2	50°C	48" x 15.86" x 15"	163 / 183
HC1212354XJ4	4X	12,000	Stainless steel	230/1/50	8.2	50°C	48" x 15.86" x 15"	163 / 183
HC12138512J4	12	12,000	Powder coated steel	380/1/50	4.7	50°C	57.6" x 15.86" x 15"	237 / 280
HC12138504J4	4	12,000	Powder coated steel	380/1/50	4.7	50°C	57.6" x 15.86" x 15"	237 / 280
HC1213854XJ4	4X	12,000	Stainless steel	380/1/50	4.7	50°C	57.6" x 15.86" x 15"	237 / 280
HC12140512J4	12	12,000	Powder coated steel	400/1/50	4.7	50°C	57.6" x 15.86" x 15"	237 / 280
HC12140504J4	4	12,000	Powder coated steel	400/1/50	4.7	50°C	57.6" x 15.86" x 15"	237 / 280
HC1214054XJ4	4X	12,000	Stainless steel	400/1/50	4.7	50°C	57.6" x 15.86" x 15"	237 / 280

Testing done under controlled conditions. Actual performance may vary.

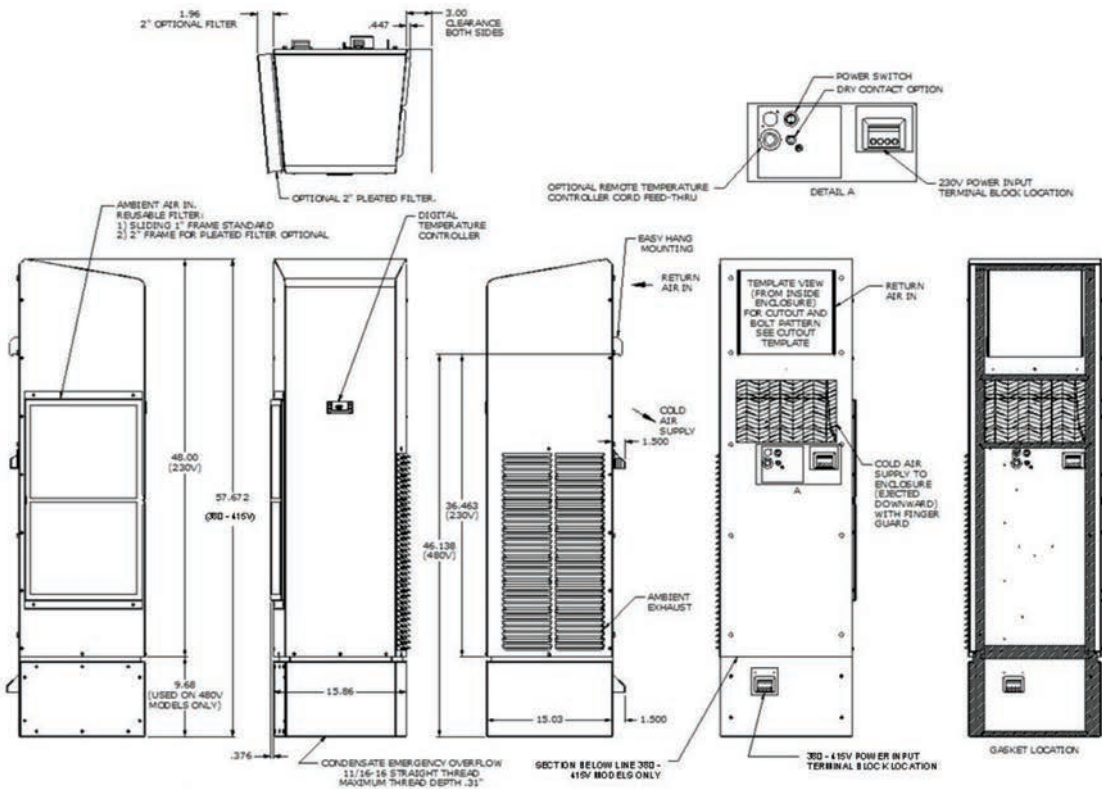
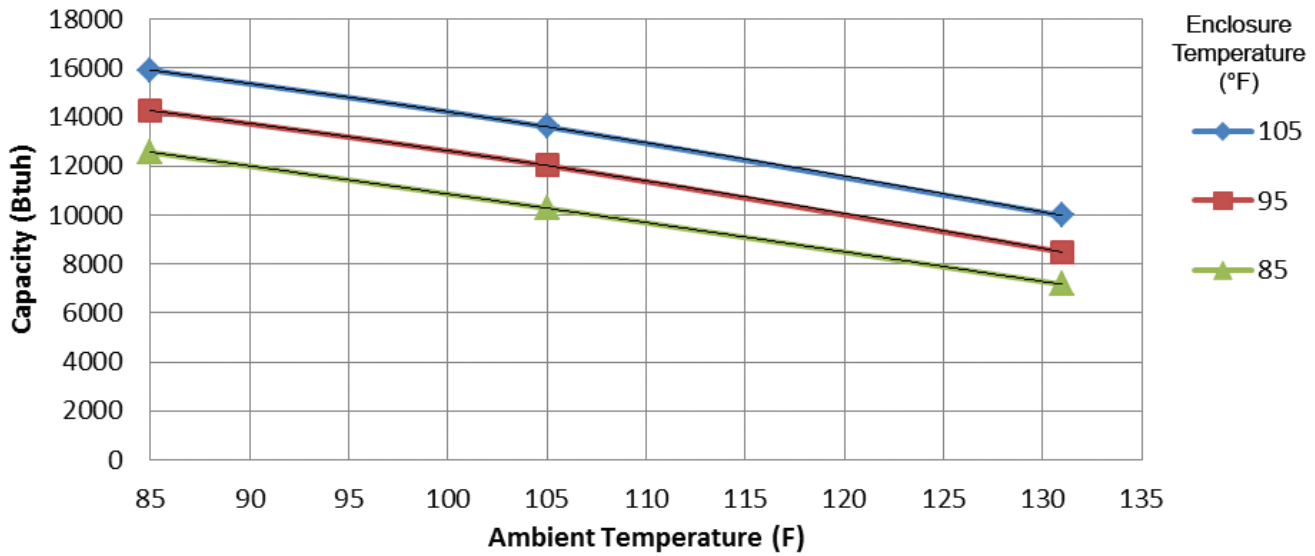

*Critical components in the NRTL Hazardous Location Listing Report must not be substituted with alternate components. Thermal Edge, Inc. and MET Labs must be notified before changes to any drawings, samples, or required documentation are approved.

ATTENTION: If ordering a replacement for a Thermal Edge air conditioner, please include the part number and serial number of the unit being replaced in your order. This will ensure that we ship a replacement that is compatible with the cutout dimensions and power connection features of the older model. All information subject to change without notice.



MADE IN AMERICA MATTERS...